



## ProMix® PD2K Dual Fluid Panel Electric Proportioner for Automatic Spray Applications

3A4486B  
EN

Electronic positive displacement proportioner for two-component materials. Automatic system with Advanced Display Module. For professional use only.



### Important Safety Instructions

Read all warnings and instructions in this manual and in your PD2K installation, repair, and associated component manuals. Save these instructions.

*See page 4 for model part numbers and approvals information.*

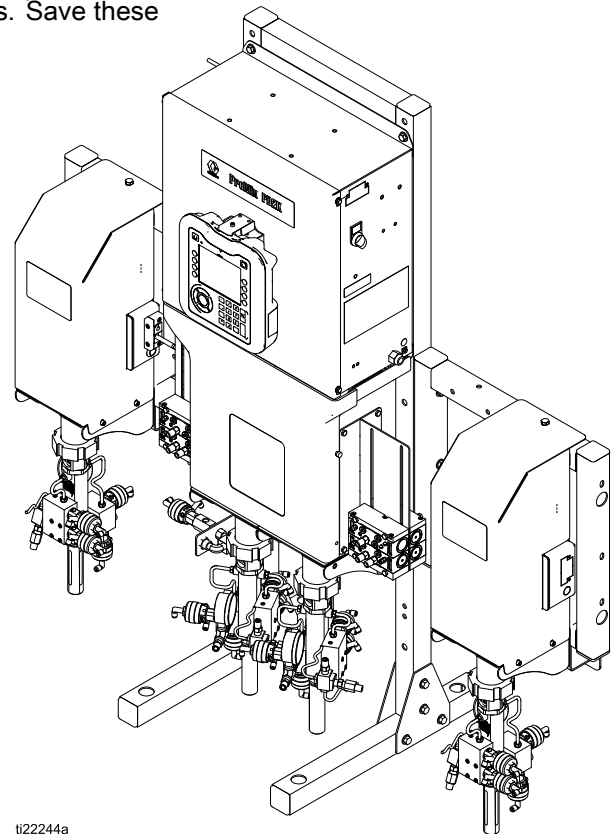

# Contents

Related Manuals .....	3	Spray Screen.....	64
Models .....	4	Fill Screen .....	65
Warnings .....	6	Usage Screen.....	66
Important Isocyanate (ISO) Information.....	9	Jobs Screen .....	67
Important Acid Catalyst Information .....	10	Errors Screen .....	67
General Information .....	11	Events Screen .....	67
Advanced Display Module (ADM) .....	12	Setup Mode Screens .....	68
ADM Display.....	12	Password Screen.....	68
USB Download Procedure .....	12	System Screen 1 .....	68
USB Upload Procedure .....	13	System Screen 2 .....	69
ADM Keys and Indicators .....	14	System Screen 3 .....	70
Soft Key Icons .....	15	System Screen 4 .....	71
Navigating the Screens .....	16	System Screen 5 .....	72
Screen Icons .....	16	Gateway Screen .....	73
Pre-Operation Tasks.....	17	Recipe Screen.....	74
Pre-operation Checklist .....	17	Flush Screen .....	77
Power On .....	17	Air/Solvent Chop.....	78
Initial System Setup .....	18	Pump Screen 1 .....	79
Flush Before Using Equipment.....	18	Custom Valve Mapping .....	80
Valve Settings.....	18	Pump Screen 2.....	84
Pressure Relief Procedure .....	19	Pump Screen 3.....	85
Without Color Change .....	19	Calibration Screens.....	86
With Color Change.....	19	Maintenance Screens.....	88
Operation Using Advanced Display Module (ADM).....	20	Advanced Screen 1.....	90
Prime and Fill the System.....	20	Advanced Screen 2.....	91
Pre-Fill the Pump .....	20	Advanced Screen 3.....	91
Spraying.....	20	Advanced Screen 4.....	92
Purging .....	21	Diagnostic Screens .....	93
Shutdown .....	22	Calibration Checks.....	94
Operation Using a Programmable Logic Controller (PLC) .....	23	Pump Pressure Check .....	94
Network Communications and Discrete I/O .....	23	Pump Volume Check.....	95
Discrete I/O .....	23	Solvent Meter Calibration .....	95
Communication Gateway Module (CGM) Details .....	26	Color Change.....	96
Network Communication I/O Data Map .....	27	Multiple Color Systems.....	96
Operation Flow Charts .....	42	System Errors .....	97
Network Communication - Dynamic Command Structure (DCS) .....	50	On-Screen Help.....	97
PLC Diagnostic Screens.....	59	To Clear Error and Restart.....	98
Flow Control System .....	60	Gun Trigger Input Function .....	98
Run Mode Screens.....	61	Error Codes.....	99
Opening Screen.....	61	Maintenance .....	109
Home Screen .....	61	Preventive Maintenance Schedule .....	109
		Flushing .....	109
		Cleaning the ADM.....	109
		Appendix A: Integration with Allen Bradley PLC.....	110
		Technical Data .....	113

# Related Manuals

Current manuals are available at [www.graco.com](http://www.graco.com).

Manual No.	Description
332709	ProMix PD2K Proportioner for Automatic Spray Applications, Repair — Parts
332458	ProMix PD2K Proportioner for Automatic Spray Applications, Installation
332339	Dosing Pumps, Instructions — Parts
332454	Color/Catalyst Dispense Valves, Instructions — Parts

Manual No.	Description
333282	Color Change and Remote Mix Manifold Kits, Instructions — Parts
332456	Pump Expansion Kits, Instructions — Parts
334183	Modbus TCP Gateway Module, Instructions — Parts
334494	ProMix PD2K CGM Installation Kits, Instructions — Parts

# Models

See Figs. 1–6 for component identification labels, including approval information and certification.

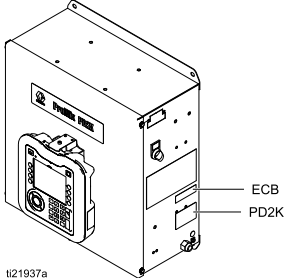
Part No.	Series	Maximum Air Working Pressure	Maximum Fluid Working Pressure	Location of PD2K and Electrical Control Box (ECB) Labels
AC1002	A	100 psi (0.7 MPa, 7.0 bar)	300 psi (2.068 MPa, 20.68 bar)	 <p>i21937a</p>
AC3002 Acid-based Material				
AC2002	A	100 psi (0.7 MPa, 7.0 bar)	1500 psi (10.34 MPa, 103.4 bar)	
AC4002 Acid-based Material				



**ProMix® PD2K / PD1K**  
Electronic Proportioner



II 2 G  
Ex ia IIA T3  
FM13 ATEX 0026  
IECEX FMG 13.0011





APPROVED  
FM16US0241  
FM16CA0129  
Intrinsically safe  
equipment for Class I,  
Div 1, Group D, T3  
Ta = 2°C to 50°C



APPROVED  
FM16US0241  
FM16CA0129  
Intrinsically safe  
equipment for Class I,  
Div 1, Group D, T3  
Ta = 2°C to 50°C

Artwork No. 294021 Rev. F

MAX AIR WPR

.7	7	100
MPa	bar	PSI

MAX FLUID WPR

2.068	20.68	300
MPa	bar	PSI

MAX TEMP 50°C (122°F)

Intrinsically Safe (IS) System. Install per IS Control Drawing No. 16P577. Control Box IS Associated

Apparatus for use in non hazardous location, with IS Connection to color change and booth control modules

Apparatus for use in:  
Class I, Division 1, Group D T3  
Hazardous Locations

Read Instruction Manual  
Warning: Substitution of components may impair intrinsic safety.

PART NO.	SERIES	SERIAL



MFG. YR.  GRACO INC.  
P.O. Box 1441  
Minneapolis, MN  
55440 U.S.A.

Figure 1 Model AC1002 & AC3002 (Low Pressure) Identification Label

**ProMix® PD2K / PD1K**

PART NO. SERIES NO. MFG. YR.

--	--	--



GRACO INC.  
P.O. Box 1441  
Minneapolis, MN  
55440 U.S.A.



APPROVED  
FM16US0241  
FM16CA0129

**POWER REQUIREMENTS**

VOLTS	90-250 ~	
AMPS	7 AMPS MAX	
	50/60 Hz	

Um: 250 V



II (2) G  
[Ex ia] IIA Gb  
FM13 ATEX 0026  
IECEX FMG 13.0011



Artwork No. 294024 Rev. D



Figure 2 26A188 Control Box Identification Label

Continued on the next page.







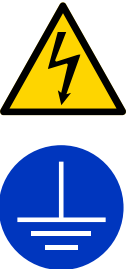







# Warnings

The following warnings are for the setup, use, grounding, maintenance, and repair of this equipment. The exclamation point symbol alerts you to a general warning and the hazard symbols refer to procedure-specific risks. When these symbols appear in the body of this manual or on warning labels, refer back to these Warnings. Product-specific hazard symbols and warnings not covered in this section may appear throughout the body of this manual where applicable.

 <h2 style="margin: 0;">WARNING</h2>	
	<p><b>FIRE AND EXPLOSION HAZARD</b></p> <p>Flammable fumes, such as solvent and paint fumes, in <b>work area</b> can ignite or explode. Paint or solvent flowing through the equipment can cause static sparking. To help prevent fire and explosion:</p> <ul style="list-style-type: none"> <li>• Use equipment only in well ventilated area.</li> <li>• Eliminate all ignition sources; such as pilot lights, cigarettes, portable electric lamps, and plastic drop cloths (potential static sparking).</li> <li>• Ground all equipment in the work area. See <b>Grounding</b> instructions.</li> <li>• Never spray or flush solvent at high pressure.</li> <li>• Keep work area free of debris, including solvent, rags and gasoline.</li> <li>• Do not plug or unplug power cords, or turn power or light switches on or off when flammable fumes are present.</li> <li>• Use only grounded hoses.</li> <li>• Hold gun firmly to side of grounded pail when triggering into pail. Do not use pail liners unless they are anti-static or conductive.</li> <li>• <b>Stop operation immediately</b> if static sparking occurs or you feel a shock. Do not use equipment until you identify and correct the problem.</li> <li>• Keep a working fire extinguisher in the work area.</li> </ul>
	<p><b>ELECTRIC SHOCK HAZARD</b></p> <p>This equipment must be grounded. Improper grounding, setup, or usage of the system can cause electric shock.</p> <ul style="list-style-type: none"> <li>• Turn off and disconnect power at main switch before disconnecting any cables and before servicing or installing equipment.</li> <li>• Connect only to grounded power source.</li> <li>• All electrical wiring must be done by a qualified electrician and comply with all local codes and regulations.</li> </ul>



# WARNING

  	<p><b>INTRINSIC SAFETY</b></p> <p>Intrinsically safe equipment that is installed improperly or connected to non-intrinsically safe equipment will create a hazardous condition and can cause fire, explosion, or electric shock. Follow local regulations and the following safety requirements.</p> <ul style="list-style-type: none"> <li>• Be sure your installation complies with national, state, and local codes for the installation of electrical apparatus in a Class I, Group D, Division 1 (North America) or Class I, Zones 1 and 2 (Europe) Hazardous Location, including all of the local safety fire codes (for example, NFPA 33, NEC 500 and 516, OSHA 1910.107, etc.).</li> <li>• To help prevent fire and explosion: <ul style="list-style-type: none"> <li>• Do not install equipment approved only for a non-hazardous location in a hazardous location. See model ID label for the intrinsic safety rating of your model.</li> <li>• Do not substitute system components as this may impair intrinsic safety.</li> </ul> </li> <li>• Equipment that comes in contact with the intrinsically safe terminals must be rated for Intrinsic Safety. This includes DC voltage meters, ohmmeters, cables, and connections. Remove the unit from the hazardous area when troubleshooting.</li> </ul>
    	<p><b>SKIN INJECTION HAZARD</b></p> <p>High-pressure fluid from dispensing device, hose leaks, or ruptured components will pierce skin. This may look like just a cut, but it is a serious injury that can result in amputation. <b>Get immediate surgical treatment.</b></p> <ul style="list-style-type: none"> <li>• Do not point dispensing device at anyone or at any part of the body.</li> <li>• Do not put your hand over the fluid outlet.</li> <li>• Do not stop or deflect leaks with your hand, body, glove, or rag.</li> <li>• Follow the <b>Pressure Relief Procedure</b> when you stop dispensing and before cleaning, checking, or servicing equipment.</li> <li>• Tighten all fluid connections before operating the equipment.</li> <li>• Check hoses and couplings daily. Replace worn or damaged parts immediately.</li> </ul>
 	<p><b>MOVING PARTS HAZARD</b></p> <p>Moving parts can pinch, cut or amputate fingers and other body parts.</p> <ul style="list-style-type: none"> <li>• Keep clear of moving parts.</li> <li>• Do not operate equipment with protective guards or covers removed.</li> <li>• Pressurized equipment can start without warning. Before checking, moving, or servicing equipment, follow the <b>Pressure Relief Procedure</b> and disconnect all power sources.</li> </ul>
 	<p><b>TOXIC FLUID OR FUMES</b></p> <p>Toxic fluids or fumes can cause serious injury or death if splashed in the eyes or on skin, inhaled, or swallowed.</p> <ul style="list-style-type: none"> <li>• Read MSDSs to know the specific hazards of the fluids you are using.</li> <li>• Store hazardous fluid in approved containers, and dispose of it according to applicable guidelines.</li> <li>• Always wear chemically impermeable gloves when spraying, dispensing, or cleaning equipment.</li> </ul>



# WARNING



## PERSONAL PROTECTIVE EQUIPMENT

Always wear appropriate personal protective equipment and cover all skin when spraying, servicing equipment, or when in the work area. Protective equipment helps prevent serious injury, including long-term exposure; inhalation of toxic fumes, mists or vapors; allergic reaction; burns; eye injury and hearing loss. This protective equipment includes but is not limited to:

- A properly fitting respirator, which may include a supplied-air respirator, chemically impermeable gloves, protective clothing and foot coverings as recommended by the fluid manufacturer and local regulatory authority.
- Protective eyewear and hearing protection.



## EQUIPMENT MISUSE HAZARD

Misuse can cause death or serious injury.







- Do not operate the unit when fatigued or under the influence of drugs or alcohol.
- Do not exceed the maximum working pressure or temperature rating of the lowest rated system component. See **Technical Data** in all equipment manuals.
- Use fluids and solvents that are compatible with equipment wetted parts. See **Technical Data** in all equipment manuals. Read fluid and solvent manufacturer's warnings. For complete information about your material, request MSDS from distributor or retailer.
- Do not leave the work area while equipment is energized or under pressure.
- Turn off all equipment and follow the **Pressure Relief Procedure** when equipment is not in use.
- Check equipment daily. Repair or replace worn or damaged parts immediately with genuine manufacturer's replacement parts only.
- Do not alter or modify equipment. Alterations or modifications may void agency approvals and create safety hazards.
- Make sure all equipment is rated and approved for the environment in which you are using it.
- Use equipment only for its intended purpose. Call your distributor for information.
- Route hoses and cables away from traffic areas, sharp edges, moving parts, and hot surfaces.
- Do not kink or over bend hoses or use hoses to pull equipment.
- Keep children and animals away from work area.
- Comply with all applicable safety regulations.





# Important Isocyanate (ISO) Information

Isocyanates (ISO) are catalysts used in two component materials.

## Isocyanate Conditions

				
<p>Spraying or dispensing fluids that contain isocyanates creates potentially harmful mists, vapors, and atomized particulates</p> <ul style="list-style-type: none"> <li>• Read and understand the fluid manufacturer's warnings and Safety Data Sheet (SDS) to know specific hazards and precautions related to isocyanates.</li> <li>• Use of isocyanates involves potentially hazardous procedures. Do not spray with the equipment unless you are trained, qualified, and have read and understood the information in this manual and in the fluid manufacturer's application instructions and SDS.</li> <li>• Use of incorrectly maintained or mis-adjusted equipment may result in improperly cured material. Equipment must be carefully maintained and adjusted according to instructions in the manual.</li> <li>• To prevent inhalation of isocyanate mists, vapors, and atomized particulates, everyone in the work area must wear appropriate respiratory protection. Always wear a properly fitting respirator, which may include a supplied-air respirator. Ventilate the work area according to instructions in the fluid manufacturer's SDS.</li> <li>• Avoid all skin contact with isocyanates. Everyone in the work area must wear chemically impermeable gloves, protective clothing and foot coverings as recommended by the fluid manufacturer and local regulatory authority. Follow all fluid manufacturer recommendations, including those regarding handling of contaminated clothing. After spraying, wash hands and face before eating or drinking.</li> </ul>				

## Keep Components A and B Separate

				
<p>Cross-contamination can result in cured material in fluid lines which could cause serious injury or damage equipment. To prevent cross-contamination:</p> <ul style="list-style-type: none"> <li>• <b>Never</b> interchange component A and component B wetted parts.</li> <li>• Never use solvent on one side if it has been contaminated from the other side.</li> </ul>				

## Moisture Sensitivity of Isocyanates

Exposure to moisture (such as humidity) will cause ISO to partially cure; forming small, hard, abrasive crystals, which become suspended in the fluid. Eventually a film will form on the surface and the ISO will begin to gel, increasing in viscosity.

<b>NOTICE</b>
<p>Partially cured ISO will reduce performance and the life of all wetted parts.</p> <ul style="list-style-type: none"> <li>• Always use a sealed container with a desiccant dryer in the vent, or a nitrogen atmosphere. <b>Never</b> store ISO in an open container.</li> <li>• Keep the ISO pump wet cup or reservoir (if installed) filled with appropriate lubricant. The lubricant creates a barrier between the ISO and the atmosphere.</li> <li>• Use only moisture-proof hoses compatible with ISO.</li> <li>• Never use reclaimed solvents, which may contain moisture. Always keep solvent containers closed when not in use.</li> <li>• Always lubricate threaded parts with an appropriate lubricant when reassembling.</li> </ul>

**NOTE:** The amount of film formation and rate of crystallization varies depending on the blend of ISO, the humidity, and the temperature.

## Changing Materials

<b>NOTICE</b>
<p>Changing the material types used in your equipment requires special attention to avoid equipment damage and downtime.</p> <ul style="list-style-type: none"> <li>• When changing materials, flush the equipment multiple times to ensure it is thoroughly clean.</li> <li>• Always clean the fluid inlet strainers after flushing.</li> <li>• Check with your material manufacturer for chemical compatibility.</li> <li>• When changing between epoxies and urethanes or polyureas, disassemble and clean all fluid components and change hoses. Epoxies often have amines on the B (hardener) side. Polyureas often have amines on the A (resin) side.</li> </ul>

# Important Acid Catalyst Information

The PD2K AC4002 Proportioner is designed for acid catalysts ("acid") currently used in two-component, wood-finishing materials. Current acids in use (with pH levels as low as 1) are more corrosive than earlier acids. More corrosion-resistant wetted materials of construction are required, and must be used without substitution, to withstand the increased corrosive properties of these acids.

## Acid Catalyst Conditions

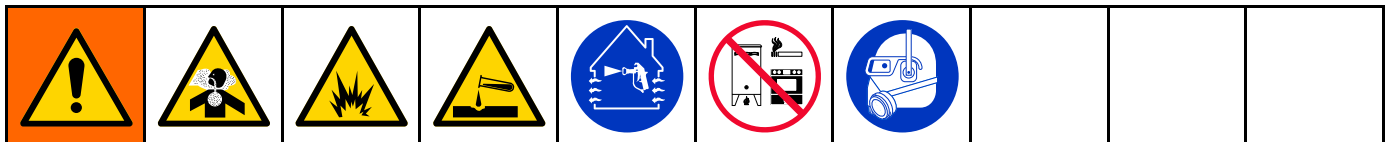

Acid is flammable, and spraying or dispensing acid creates potentially harmful mists, vapors, and atomized particulates. To help prevent fire and explosion and serious injury:

- Read and understand the acid manufacturer's warnings and Safety Data Sheet (SDS) to know specific hazards and precautions related to the acid.
- Use only genuine, manufacturer's recommended acid-compatible parts in the catalyst system (hoses, fittings, etc). A reaction may occur between any substituted parts and the acid.
- To prevent inhalation of acid mists, vapors, and atomized particulates, everyone in the work area must wear appropriate respiratory protection. Always wear a properly fitting respirator, which may include a supplied-air respirator. Ventilate the work area according to instructions in the acid manufacturer's SDS.
- Avoid all skin contact with acid. Everyone in the work area must wear chemically impermeable gloves, protective clothing, foot coverings, aprons, and face shields as recommended by the acid manufacturer and local regulatory authority. Follow all acid manufacturer recommendations, including those regarding handling of contaminated clothing. Wash hands and face before eating or drinking.
- Regularly inspect equipment for potential leaks and remove spills promptly and completely to avoid direct contact or inhalation of the acid and its vapors.
- Keep acid away from heat, sparks, and open flames. Do not smoke in the work area. Eliminate all ignition sources.
- Store acid in the original container in a cool, dry, and well-ventilated area away from direct sunlight and away from other chemicals in accordance with acid manufacturer's recommendations. To avoid corrosion of containers, do not store acid in substitute containers. Reseal the original container to prevent vapors from contaminating the storage space and surrounding facility.

## Moisture Sensitivity of Acid Catalysts

Acid catalysts can be sensitive to atmospheric moisture and other contaminants. It is recommended the catalyst pump and valve seal areas exposed to atmosphere are flooded with ISO oil, TSL, or other compatible material to prevent acid build-up and premature seal damage and failure.

### NOTICE

Acid build-up will damage the valve seals and reduce the performance and life of the catalyst pump. To prevent exposing acid to moisture:

- Always use a sealed container with a desiccant dryer in the vent, or a nitrogen atmosphere. Never store acids in an open container.
- Keep the catalyst pump and the valve seals filled with the appropriate lubricant. The lubricant creates a barrier between the acid and the atmosphere.
- Use only moisture-proof hoses compatible with acids.
- Always lubricate threaded parts with an appropriate lubricant when reassembling.

## **General Information**

- Reference numbers and letters in parentheses in the text refer to numbers and letters in the illustrations.
- Be sure all accessories are adequately sized and pressure-rated to meet system requirements.
- To protect the screens from paints and solvents, clear-plastic protective shields (10 per pack) are available. Order Part No. 197902 for the Advanced Display Module. Clean the screens with a dry cloth if necessary.

# Advanced Display Module (ADM)

## ADM Display

The ADM display shows graphical and text information related to setup and spray operations.

For detail on the display and individual screens, see [Run Mode Screens, page 61](#), or [Setup Mode Screens, page 68](#).

Keys are used to input numerical data, enter setup screens, navigate within a screen, scroll through screens, and select setup values.

### NOTICE

To prevent damage to the softkey buttons, do not press the buttons with sharp objects such as pens, plastic cards, or fingernails.

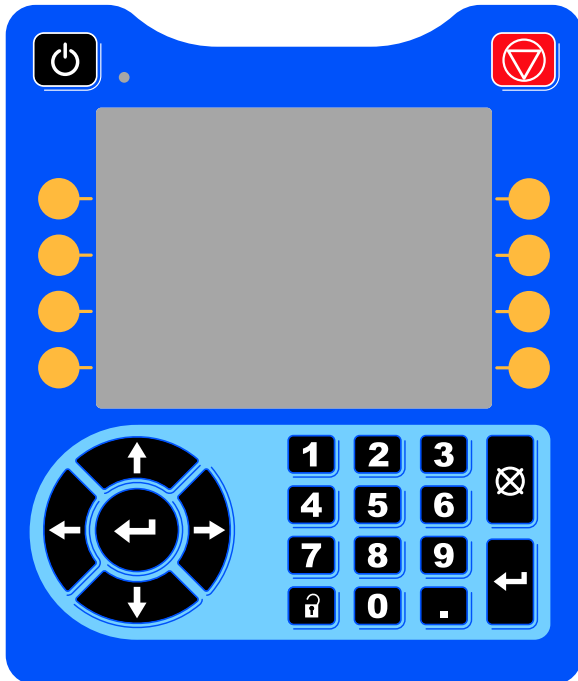

Figure 8 Advanced Display Module

## USB Download Procedure

Use the USB port on the ADM to download or upload data.

1. Enable USB downloads. See [Advanced Screen 3, page 91](#).
2. Remove the cover from the USB port on the bottom of the ADM. Insert the USB drive.
3. During the download, USB BUSY appears on the screen.
4. When the download is complete, USB IDLE appears on the screen. The USB drive may then be removed.

**NOTE:** If the download operation takes longer than 60 seconds, the message disappears. To determine if the USB is busy or idle, check the Error Status bar on the screen. If idle, remove the USB.

5. Insert the USB flash drive into the USB port of the computer.
6. The USB flash drive window automatically opens. If it does not, open the USB flash drive from within Windows® Explorer.
7. Open Graco folder.
8. Open system folder. If downloading data from more than one system, there will be more than one folder. Each folder is labeled with the corresponding serial number of the ADM. (The serial number is on the back of the ADM.)
9. Open DOWNLOAD folder.
10. Open LOG FILES folder labeled with the highest number. The highest number indicates the most recent data download.
11. Open log file. Log files open in Microsoft® Excel® by default if the program is installed. They also can be opened in any text editor of Microsoft® Word.

**NOTE:** All USB logs are saved in Unicode (UTF-16) format. If opening the log file in Microsoft Word, select Unicode encoding.

12. Always reinstall the USB cover after removing the USB, to keep the drive free of dirt and dust.

## USB Upload Procedure

Use this procedure to install a system configuration file and/or a custom language file.

1. If necessary, follow the **USB Download Procedure**, to automatically generate the proper folder structure on the USB flash drive.
2. Insert the USB flash drive into the USB port of the computer.
3. The USB flash drive window automatically opens. If it does not, open the USB flash drive from within Windows Explorer.
4. Open the Graco folder.
5. Open the system folder. If working with more than one system, there will be more than one folder within the Graco folder. Each folder is labeled with the corresponding serial number of the ADM. (The serial number is on the back of the module.)
6. If installing the system configuration settings file, place SETTINGS.TXT file into UPLOAD folder.
7. If installing the custom language file, place DISPTXT.TXT file into UPLOAD folder.
8. Remove the USB flash drive from the computer.
9. Install the USB flash drive into the USB port of the ProMix PD2K system USB port.
10. During the upload, USB BUSY displays on the screen.
11. Remove the USB flash drive from the USB port.

**NOTE:** If the custom language file was installed, users can now select the new language from the Language drop-down menu in the Advanced Setup Screen 1.







**NOTE:** If the system configuration settings file was installed, it is recommended to remove the file from the UPLOAD folder on the USB flash drive. This will prevent inadvertently overwriting any future setup changes.

## ADM Keys and Indicators

### NOTICE

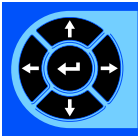
To prevent damage to the softkey buttons, do not press the buttons with sharp objects such as pens, plastic cards, or fingernails.

Table 1 : ADM Keys and Indicators

Key	Function
 <p>Startup/Shutdown Key and Indicator</p>	<p>Press to startup or shutdown the pump/motor.</p> <ul style="list-style-type: none"> <li>• Solid green indicates that power is applied to the motor.</li> <li>• Solid yellow indicates that power to the motor is off.</li> <li>• Blinking green or yellow indicates that the system is in Setup mode.</li> </ul>
 <p>Stop</p>	<p>Press to immediately stop the system and remove motor power.</p>
 <p>Soft Keys</p>	<p>Press to select the specific screen or operation shown on the display directly next to each key. The top left soft key is the Edit key, which allows access to any settable fields on a screen.</p>
 <p>Navigation Keys</p>	<ul style="list-style-type: none"> <li>• <i>Left/Right Arrows:</i> Use to move from screen to screen.</li> <li>• <i>Up/Down Arrows:</i> Use to move among fields on a screen, items on a dropdown menu, or multiple screens within a function. Also used to toggle between Mix Units on Home Screen.</li> </ul>
<p>Numeric Keypad</p>	<p>Use to input values. See <a href="#">ADM Display, page 12</a>.</p>
 <p>Cancel</p>	<p>Use to cancel a data entry field.</p>
 <p>Setup</p>	<p>Press to enter or exit Setup mode.</p>
 <p>Enter</p>	<p>Press to choose a field to update, to make a selection, to save a selection or value, to enter a screen, or to acknowledge an event.</p>











## Soft Key Icons













The following icons appear in the ADM display, directly to the left or right of the soft key which activates that operation.





**NOTICE**

To prevent damage to the softkey buttons, do not press the buttons with sharp objects such as pens, plastic cards, or fingernails.

**Table 2 : Soft Key Functions**

Key	Function
 Enter Screen	Press to enter screen for editing. Highlights editable data on a screen. Use Up/Down arrows to move between data fields on the screen.
 Exit Screen	Press to exit screen after editing.
 Accept	Press to accept calibration value.
 Cancel	Press to cancel or reject calibration value.
 Toggle	Press to switch between Mix Units on the Spray and Fill screens.
 Prime Pump	Press to start a pump priming procedure.
 Pre-Fill Pump	Press to mark pump as filled. (Only for applicable pumps.)
 Line/Fill/Run	Press to start a line fill procedure.
 Mix	Press to start a spray procedure.
 Purge	Press to start a purge procedure.

Key	Function
 Standby	Press to stop all pumps and put system in Standby.
 Stop	
 Recipe Link	Press to link recipe data for a specific recipe on both Mix Units.
 Pressure Check	Press to start a pump pressure check.
 Volume Check	Press to start a pump volume check.
 Pressure Relief	Appears on the Maintenance screen to relieve pump pressure out the color change dump valve.
 Job Complete	Press to log the material usage and increment the job number, for Mix Unit #1 or Mix Unit #2.
 Counter Reset	Press to reset the current usage counter.
 Move Cursor to Left	Appears on the User ID Keyboard screen. Use to move cursor to the left.
 Move Cursor to Right	Appears on the User ID Keyboard screen. Use to move cursor to the right.
 Erase All	Appears on the User ID Keyboard screen. Use to erase all characters.
 Backspace	Appears on the User ID Keyboard screen. Use to erase one character at a time.

Key	Function
 Upper Case/Lower Case	Appears on the User ID Keyboard screen. Use to change case (upper/lower).
 Info	Press to get more information on active system error.
 Troubleshooting	Press to see troubleshooting information for system error.
 QR Code	Press to see QR Code for system error.

## Navigating the Screens

There are two sets of screens:

- The Run screens control mixing operations and display system status and data.
- The Setup screens control system parameters and advanced features.

Press  on any Run screen to enter the Setup screens. If the system has a password lock, the Password screen displays. If the system is not locked (password is set to 0000), System Screen 1 displays.

Press  on any Setup screen to return to the Home screen.

















Press the Enter soft key  to activate the editing function on any screen.

Press the Exit soft key  to exit any screen.

Use the other softkeys to select the function adjacent to them.

## Screen Icons

As you move through the screens, you will notice that icons are used frequently to simplify global communication. The following descriptions explain what each icon represents.

Screen Icons	
 User ID	 Job Number
 Potlife	 1:1 Target Ratio
 Recipe Number	 Flow Rate
 Pressure	 Volume
 Material A	 Material B
 Material A+B	 Solvent
 Calendar	 Time
 Alarm/Advisory	 Deviation
 Mix Unit	



# Pre-Operation Tasks

## Pre-operation Checklist

Go through the Pre-Operation Checklist daily, before each use.

✓	Checklist
	<p><b>System grounded</b></p> <p>Verify all grounding connections were made. See <b>Grounding</b> in the Installation manual.</p>
	<p><b>All connections tight and correct</b></p> <p>Verify all electrical, fluid, air, and system connections are tight and installed according to the Installation manual.</p>
	<p><b>Fluid supply containers filled</b></p> <p>Check component A and B and solvent supply containers.</p>
	<p><b>Dose valves set</b></p> <p>Check that dose valves are set 1–1/4 turns open. Start with the settings recommended in <a href="#">Valve Settings, page 18</a>, then adjust as needed.</p>
	<p><b>Fluid supply valves open and pressure set</b></p> <p>The recommended component A and B fluid supply pressures are 1/2 to 2/3 of the target spray pressure.</p> <p><b>NOTE:</b> Low pressure systems may be set within a range of ± 100 psi (0.7 MPa, 7 bar); high pressure systems may be set within a range of ± 300 psi (2.1 MPa, 21 bar). If the inlet pressure is higher than the outlet pressure, ratio accuracy may be affected.</p>
	<p><b>Solenoid pressure set</b></p> <p>85-100 psi inlet air supply (0.6-0.7 MPa, 6-7 bar).</p>

## Power On

1. Turn the AC Power Switch (P) ON (I = ON, 0 = OFF).
2. The Graco logo will display while the system initializes, followed by the Home screen.
3. Press the Start key  to display the Pump Power pop-up screen.

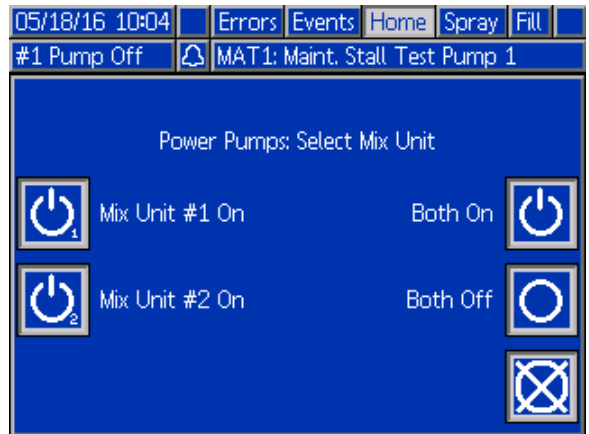

The softkey options allow for powering a specific Mix Unit, or both at the same time. The system status will change from “System Off” to “Startup.” Once the pumps are powered and are in the Home position, the system status will change from “Startup” to “Standby.”

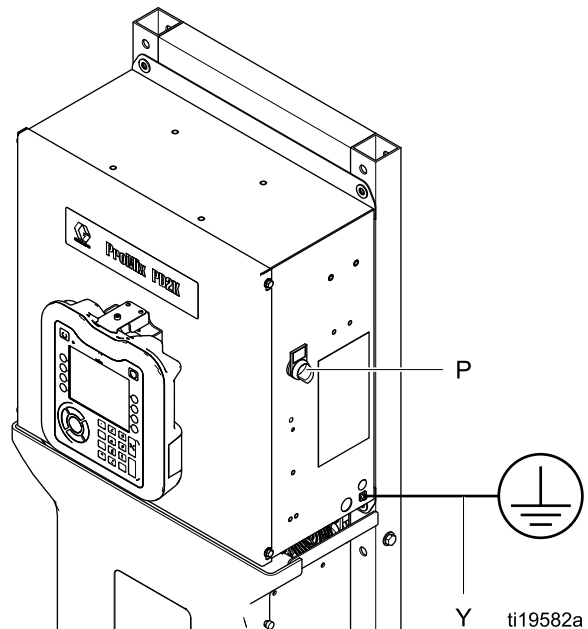

Figure 9 Power Switch

## Initial System Setup

1. Change optional setup selections to desired parameters, as described in [Setup Mode Screens, page 68](#).
2. Set recipe and flush information as described in [Recipe Screen, page 74](#), and [Flush Screen, page 77](#).

## Flush Before Using Equipment

The pump fluid section was tested with lightweight oil, which is left in the fluid passages to protect parts. To avoid contaminating your fluid with oil, flush the equipment with a compatible solvent before using the equipment.

## Valve Settings

Dose valves and purge valves are factory set with the hex nut (E) 1-1/4 turns out from fully closed.

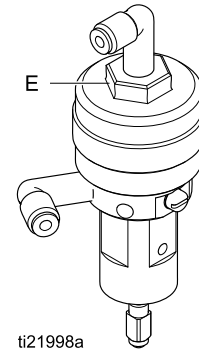

ti21998a

Figure 10 Valve Adjustment

# Pressure Relief Procedure



Follow the **Pressure Relief Procedure** whenever you see this symbol.

This equipment stays pressurized until pressure is manually relieved. To help prevent serious injury from pressurized fluid, such as skin injection, splashing fluid and moving parts, follow the **Pressure Relief Procedure** when you stop spraying and before cleaning, checking, or servicing the equipment.

## Without Color Change

**NOTE:** The following procedure relieves all fluid and air pressure in the system. Use your control interface to issue the necessary commands to your system.

1. Turn off the supply pumps. Open the drain valve on the supply line fluid filter to relieve pressure in the supply line.
2. Command Mix Unit #1 to Standby. From Maintenance Screen 4 on the ADM, check the box in the field labeled Gun for the color or catalyst in the pump. Trigger the spray device to relieve pressure. Repeat for each pump.
3. Flush the remote mix manifold and spray device. See [Flush Mixed Material, page 21](#).
4. Shut off the solvent supply pump. To relieve pressure, command Mix Unit #1 to Purge and trigger the spray device. When the pressure is relieved, command Mix Unit #1 to Standby to avoid getting a Purge Incomplete alarm.
5. If pressure remains in the solvent line between the solvent supply pump and the solvent valve:
  - VERY SLOWLY loosen a fitting to relieve pressure gradually.
  - Loosen the fitting completely.
6. Repeat for Mix Unit #2

## With Color Change

**NOTE:** The following procedure relieves all fluid and air pressure in the system.

1. Turn off the supply pumps. Open the drain valve on the supply line fluid filter to relieve pressure in the supply lines. Do this for each color.

2.

--	--	--	--	--

To help prevent fire and explosion, shut off electrostatics before flushing.

If using an electrostatic gun, shut off the electrostatics before flushing the gun.

3. Trigger the gun to relieve pressure. From Maintenance Screen 5 on the ADM, check the box in the field labeled Gun for each color used with Mix Unit #1, to manually open each color valve.
4. Set the system to Recipe 0 to flush the pumps and to purge to the spray device. Hold the gun trigger open after the solvent valve shuts off to relieve all pressure. When flushing is complete Mix Unit #1 will go to Standby.
5. Shut off the solvent supply pump. Set Mix Unit #1 to Recipe 0 to flush solvent from the pumps and to purge to the spray device. Command Mix Unit #1 to Standby after just a couple of seconds, to avoid getting a Purge Incomplete alarm.
6. If pressure remains in the solvent line between the solvent supply pump and the solvent valve:
  - VERY SLOWLY loosen a fitting to relieve pressure gradually.
  - Loosen the fitting completely.
7. Verify on the ADM Home Screen that neither pump 1 nor 2 is showing any pressure.
8. Repeat for Mix Unit #2 and pumps 3 and 4.

# Operation Using Advanced Display Module (ADM)

## Prime and Fill the System

**NOTE:** See [Run Mode Screens, page 61](#), for further screen information, if needed.

**NOTE:** You must prime the input lines to the pumps or the inputs to the color change valves before priming the pump and filling the entire system.

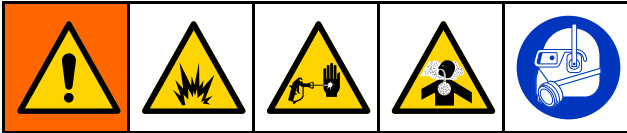



1. If using an electrostatic gun, shut off the electrostatics before filling the lines.
2. Adjust the main air pressure. To ensure proper operation, set the main air pressure as close to 100 psi (0.7 MPa, 7.0 bar) as possible. Do not use less than 85 psi (0.6 MPa, 6.0 bar).
3. If this is the first time starting up the system, or if lines may contain air, purge as instructed under [Flush the System, page 21](#). The equipment was tested with lightweight oil, which should be flushed out to avoid contaminating your material.

4. If the system is powered down, press  on the ADM to bring up the Pump Power pop-up screen and, using the softkeys, turn on power to a specific Mix Unit or both. Make sure that the system is in Standby mode.
5. Verify that the recipes and the flush sequences are programmed correctly by checking the [Recipe Screen, page 74](#), and the [Flush Screen, page 77](#).
6. Enable the manual override on System Screen 1.
7. Go to the [Fill Screen, page 65](#).
8. Select the desired color to load. Press the Prime

Pump key . The color will load the pump through the color stack and out the outlet stack dump valve.

**NOTE:** In a single color system, step 8 can be skipped..

9. Press the Fill Line key  to run color out to the remote mix manifold. The pump will run until you press the Stop key  to stop the pump.
10. Trigger the gun into a grounded reservoir or purge receptacle until the line is full, then press the Stop key .
11. Repeat for all material lines.

## Pre-Fill the Pump

**NOTE:** This option is only available for pumps that have color change valves and only a single material.

If a pump is filled with a material when the system is powered down, this will allow the user to change the pump's contents, without flushing the pump, the next time power is restored.

1. Enable the manual override on [System Screen 1, page 68](#).
2. Go to the [Fill Screen, page 65](#).
3. Press the Pre-Fill Pump key . The pump will change from material 61 to the proper color or catalyst.

## Spraying

To spray in a multiple color system, also see [Multiple Color Systems, page 96](#).

**NOTE:** See [Run Mode Screens, page 61](#), for further screen information, if needed.

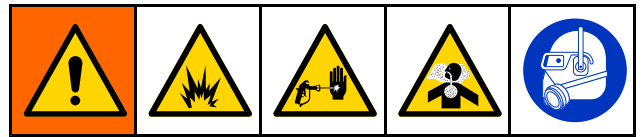

1. Command a Mix Unit to Mix. The system will load the correct mixed material volume.  
**NOTE:** The Mix Unit will automatically run a Mix Fill if the recipe is not currently loaded into the system. The Mix Fill volume calculation includes the remote mix manifold volume and the mixed material hose volume. The mixed material hose volume is determined by the gun hose length and diameter entered in [System Screen 3, page 70](#), and the remote-to-mix hose length and diameter also entered in [System Screen 3, page 70](#).
2. Adjust the flow rate by changing the target pressure (in Pressure Mode) or the target flow rate (in Flow Mode) on the Spray Screen or through the PLC. The fluid flow rate shown on the Spray screen is the combined total of component A and B out of the spray device.
3. Turn on atomizing air to the spray device. Check the spray pattern as instructed in your spray device manual.

### NOTICE

Do not allow a fluid supply tank to run empty. This can damage the pumps and lead to the proportioning of fluid and air that meets the ratio and tolerance settings of the equipment. This can further result in spraying uncatalyzed or poorly catalyzed material.

## Purging

To purge one color and fill with a new color, see [Color Change, page 96](#).

### Flush Mixed Material

To avoid fire and explosion, always ground equipment and waste container. To avoid static sparking and injury from splashing, always flush at the lowest possible pressure.

There are times when you only want to purge the remote mix manifold and the spray device, such as:

- end of potlife
- breaks in spraying that exceed the potlife
- overnight shutdown or end of shift
- before servicing the remote mix manifold, hose or gun.

1. Command the Mix Unit to Standby.
2. If you are using a high pressure spray device or an electrostatic gun, shut off the atomizing air.
- 3.

--	--	--	--	--

To reduce the risk fire and explosion, shut off electrostatics before flushing the gun.

If using an electrostatic gun, shut off the electrostatics before flushing the gun.

4. Command the Mix Unit to Purge A, Purge B, or Recipe Purge. (See [Purge Mode Sequence, page 42](#).) Trigger the spray device into a grounded metal pail until the purge sequence is complete. When done purging, the Mix Unit automatically switches to Standby mode, signalling the spray device to stop spraying.
5. If the Mix Unit is not completely clean, repeat Step 5.

**NOTE:** For optimal efficiency, adjust purge sequence times so only one cycle is required.

**NOTE:** The remote mix manifold and gun remain full of solvent after purging.

### Flush the System

To avoid fire and explosion, always ground equipment and waste container. To avoid static sparking and injury from splashing, always flush at the lowest possible pressure.



Follow this procedure before:

- the first time material is loaded into the equipment
- servicing
- shutting down equipment for an extended period of time
- putting equipment into storage

### Single Color System

1. Relieve the pressure. See [Pressure Relief Procedure, page 19](#).
2. Disconnect the color and catalyst supply lines from the pump inlet manifolds, and connect regulated solvent supply lines.
3. Set the solvent supply pressure regulator at the lowest pressure possible. Generally a setting of 25–50 psi (0.18–0.35 MPa, 1.8–3.5 bar) is sufficient.
4. Enable manual override on [System Screen 1, page 68](#).
5. On the ADM, go to the Fill screen for Mix Unit #1. Set the Material to Color (A). Press . The system will pump solvent through pump A all the way to the gun.
6. Hold a metal part of the spray device firmly to a grounded metal pail. Trigger the spray device until clean solvent dispenses.
7. On the ADM, go to the Fill screen for Mix Unit #1. Set the Material to Catalyst (B). Press . The system will pump solvent through pump B all the way to the gun.
8. Relieve the pressure. See [Pressure Relief Procedure, page 19](#)
9. Repeat for Mix Unit #2.

**Color Change System**

1. Relieve the pressure. See [Pressure Relief Procedure, page 19](#).
2. Attach regulated solvent supply lines as follows:
  - **Multiple color/single catalyst system:** On the color side, do not disconnect the color supply line from the inlet manifold of Pump A. Instead, connect a regulated solvent supply line to the designated solvent valve on the color valve manifold. On the catalyst side, disconnect the catalyst supply line from the inlet manifold of Pump B, and connect a regulated solvent supply line.
  - **Multiple color/multiple catalyst system:** Connect regulated solvent supply lines to the designated solvent valves on the color and catalyst valve manifolds. Do not connect solvent supply lines directly to the inlet manifolds of the pumps.
3. Set the solvent supply pressure regulator at the lowest pressure possible. Generally a setting of 25–50 psi (0.18–0.35 MPa, 1.8–3.5 bar) is sufficient.
4. On the ADM, go to the Fill screen for Mix Unit #1. Select Color (A). Enter the color number in the box to the right.
5. Select the Flush Line box.
6. If the solvent is not already loaded, press the Prime softkey . The Mix Unit will prime solvent into the selected pump and out the outlet dump valve.
7. Press the Fill softkey . The Mix Unit will flush the selected Color (A) line with the solvent until the user presses Stop .

8. Hold a metal part of the gun firmly to a grounded metal pail. Trigger the gun until clean solvent dispenses.
9. Repeat for each color line.
10. Relieve the pressure. See [Pressure Relief Procedure, page 19](#)
11. Repeat for Mix Unit #2.

**Shutdown**

1. Flush out the mixed material to avoid potlife errors and fluid setup in the lines. See [Purging, page 21](#).
2. Follow the [Pressure Relief Procedure, page 19](#).
3. Close the main air shutoff valve on the air supply line and on the control box.
4. Press  on the Display Module to turn off power to the pumps to display the following pop-up screen. Make sure that the system is in Standby mode.

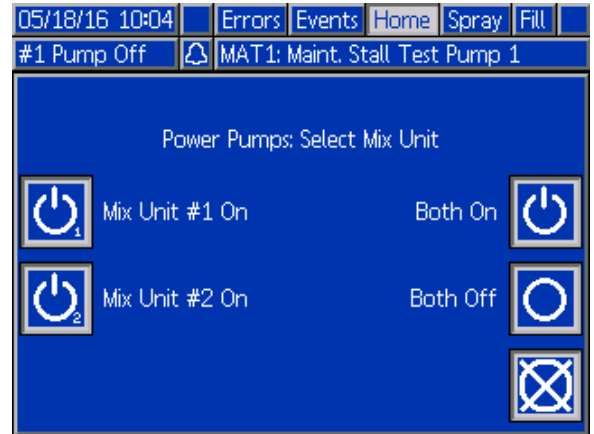

5. Select either Mix Unit, or both, to power off.
6. Shut off system power (0 position).

# Operation Using a Programmable Logic Controller (PLC)

## Network Communications and Discrete I/O

The ProMix PD2K Automatic system does not use a Booth Control module. Instead, it uses Network Communications and has optional Discrete I/O features to drive the system remotely.

Some automation control elements of the ProMix PD2K can be driven by a discrete input *or* network communications. These options need to be configured at the ADM (see [Gateway Screen, page 73](#)). The following features can be set to 'Discrete' or 'Network':

- **Flow Control** – Means of adjusting the control set point (see **Flow Control Set Point** below).
- **Gun Trigger** – Means of signaling the ProMix PD2K when the spray device is triggered.

**NOTE:** The Manual Override check box on System Screen 1 enables a user to operate the system before the automation (PLC) is available. Manual Override can be used to run all functions of the system if a proper gun trigger signal is provided. It is not intended to be the main mode of control. Graco recommends that Manual Override be disabled during normal operation to avoid driving the system in a way that conflicts with the automation sequence.

## Discrete I/O

The ProMix PD2K does not supply power for Discrete I/O. A clear understanding of these inputs is necessary to properly integrate the ProMix PD2K with the PLC or networking device. Input and output connections are made at the Discrete I/O terminal strips on the Enhanced Fluid Control Module (EFCM) inside the control box.

Table 3 and Figure 12 show where discrete I/O connections are made on the ProMix PD2K.

**Table 3 PD2K Discrete I/O Connections**

I/O Description	EFCM Connector	Pins	Type
Gun Trigger #1 Input	6	1,2	Normally Open Contact
Gun Trigger #2 Input	6	3,4	Normally Open Contact
Control Set Point #1	7	1,2	4-20 mA Input
Control Set Point #2	7	3,4	4-20 mA Input
Safety Interlock Input	5	10,11	Normally Open Contact



## Digital Inputs

- **Safety Interlock:** This normally open contact works like a soft emergency stop button. If the ProMix PD2K reads the input as CLOSED it interrupts system operation and removes power from the pumps regardless of the current operating mode. If the input is read as OPEN, the system operates normally

**NOTE:** This digital input is always enabled.

Do not toggle this input to put the system into Standby mode.

- **Gun Trigger #1 and #2:** These normally open (maintained) contacts provide a signal to the Mix Units to indicate whether or not a spray device is triggered. These inputs provide timing for alarm functions and also drives the flow control algorithm. If an input is OPEN the Mix Unit operates as though the spray device is off. The input must be maintained CLOSED to signal that the spray device is triggered.

**NOTE:** The Gun Trigger discrete inputs must be enabled individually via [System Screen 4, page 71](#), on the ADM. If it is set to 'Network' the discrete input is ignored and the spray device trigger signal is handled via the network communications.

*If enabled, it is imperative that this signal be sent any time the spray device is triggered. Without the signal, the flow control features will not work.*

## Analog Inputs

**Flow Control Set Point #1 and #2:** When enabled, these 4-20 mA signal inputs are used to set and adjust the operating flow control set point for each Mix Unit. The ProMix PD2K scales the set point linearly from 0 to the Max Set Point setting (see [System Screen 4, page 71](#)). *Examples,*

- **In Flow Control Mode:** If the Max Set Point is 500 cc/min, a 4mA signal is 0 cc/min and a 20mA signal is 500 cc/min.
- **In Pressure Control Mode:** If the Max Set Point is 500 psi, a 4mA signal is 0 psi and a 20mA signal is 500 psi.

**NOTE:** The Flow Control discrete inputs must be enabled individually via [System Screen 4, page 71](#), on the ADM. If set to 'Network' the discrete input is ignored and set point adjustment is handled via the network communications.

### 4–20 mA Flow Control Set Point Input

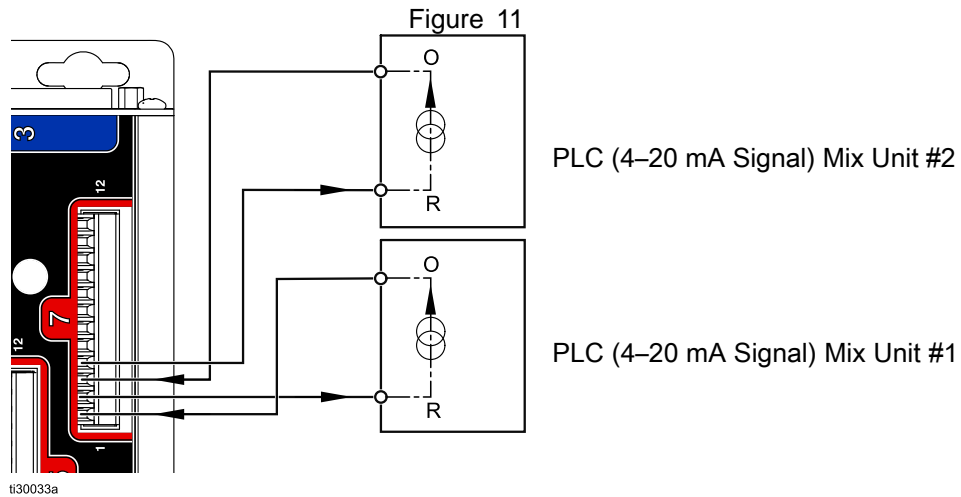

PD2K Discrete Input

O = Output  
R = Return



Discrete I/O Connections on EFCM

Figure 12

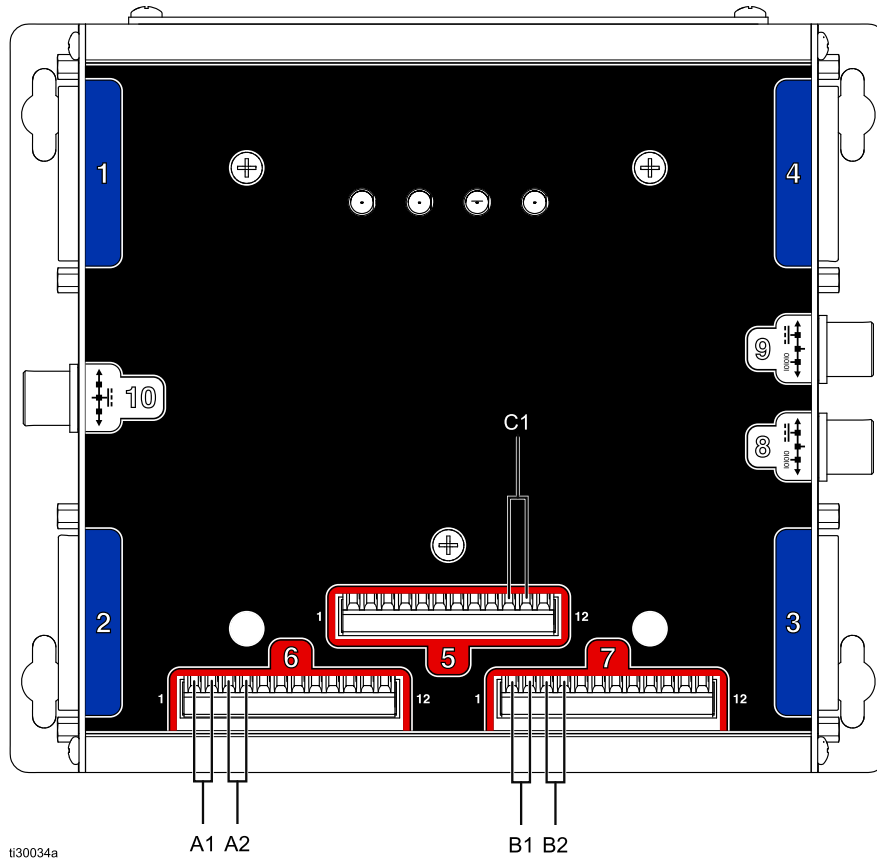

ti30034a

**KEY**

- A1 Gun Trigger Input #1
- A2 Gun Trigger Input #2
- B1 Analog Set Point Input #1
- B2 Analog Set Point Input #2
- C1 Safety Interlock Input

## Communication Gateway Module (CGM) Details

### CGM Overview

The CGM provides a control link between the PD2K system and a selected fieldbus. This linkage provides the means for remote monitoring and control by external automation systems.

### CGM Kits

The PD2K system does not come with a CGM; it must be purchased separately. The available CGM field bus protocols are listed in the tables.

**NOTE:** The CGM Installation kit is also required for DeviceNet, EtherNet/IP, and Modbus TCP protocols. PROFINET protocol calls for two CGM modules with the PD2K Dual Panel application. The PROFINET kit consolidates all installation hardware as well as the two CGM modules into a single part number.

CGM Installation Kit Part No.	Field Bus	Manual
24W829	DeviceNet EtherNet/IP Modbus TCP	334494
25D997	PROFINET	334494 312864

CGM Part No.	Fieldbus	Manual
CGMDN0	DeviceNet	312864
CGMEP0	EtherNet/IP	312864
24W462	Modbus TCP	334183

## Network Communication I/O Data Map

The PD2K has PLC Diagnostic Screens built into the software that assist in the system integration process. See [Setup Mode Screens, page 68](#).

**NOTE:** The PD2K Dual Panel system has identical network register blocks for the two Mix Units. All registers are shown with indices for Mix Unit #1 and Mix Unit #2, respectively.

### ProMix PD2K Network Outputs

The ProMix PD2K Network Outputs are Read-Only and should be treated as inputs to a PLC or other networking device. These registers provide various system and component status, measurement, and set point values. See [Network Output Data Map \(Read Only\), page 31](#).

### OUTPUT REGISTER 00 and 26: Current System Mode

The Current System Mode register contains a number that indicates the current operation mode of the PD2K system.

Number	Operation Mode	Description
1	Pump Off	The pumps are currently powered down and the Mix Unit is not in operation.
2	Recipe Change	The Mix Unit is in the process of a color change sequence.
3	Recipe Change: Purge A	The Mix Unit is purging material A as part of a recipe change.
4	Recipe Change: Purge B	The Mix Unit is purging material B as part of a recipe change.
5	Recipe Change: Fill	The Mix Unit is filling the hose from the remote valves to the mix manifold with material as part of a recipe change.
6	Mix Fill	The Mix Unit is mixing material at ratio through the mix manifold and out the gun.
7	Mix	The Mix Unit is currently mixing/spraying material.
8	Mix Idle	The Mix Unit has paused mix operation due to the absence of a gun trigger signal.
9	Purge A	The Mix Unit is purging material A while in Standby.
10	Purge B	The Mix Unit is purging material B while in Standby.
11	Standby: Mix Ready	The Mix Unit has a valid recipe loaded out to the gun.
12	Standby: Fill Ready	The Mix Unit has a valid recipe loaded in the pumps, but not in the gun.
13	Standby: Mix Not Ready	The Mix Unit requires that a recipe change operation be completed.
14	Standby: Alarm	The Mix Unit has an active alarm.
15	Line Filling/Flushing	The Mix Unit is filling/flushing a color change hose between the outlet valves and remote valves.
16	Pump Prime/Flush	The Mix Unit is priming/flushing one of the pumps.
17	Maintenance/Calibration	The Mix Unit is currently performing a calibration or maintenance procedure.

## OUTPUT REGISTER 01 and 27: Event Flag

The Event Flag register provides indication when an event (Alarm or Deviation) has occurred that requires user acknowledgement.

- The value will be 0 if there are no events requiring acknowledgement.
- The value will be 1 if there is at least one event needing acknowledgement.

## OUTPUT REGISTER 02 and 28: Actual Mix Flow/Pressure

The Actual Mix Flow/Pressure register reports back the instantaneous mixing flow rate in cc/min or mixing pressure in PSI. This register is primarily used to reflect that the Mix Unit is on its target fluid control set point. See [INPUT REGISTER 03 and 13: Mix Control Set Point, page 36](#).

**NOTE:** This register is valid only during a mix operation.

## OUTPUT REGISTER 03 and 29: Actual Mix Ratio

The Actual Mix Ratio register contains the instantaneous calculated mix ratio.

- The value reported is the ratio antecedent multiplied by 100. The ratio consequent is always 1.

*Example:* Value = 250 >> A mix ratio of 2.5:1 (Material A to Material B)

- If the current recipe ratio is 0:1 (1K recipe) this value will be 0.

This register is valid only during a mix operation.

## OUTPUT REGISTER 04 and 30: Actual Mix Potlife Remaining

The Actual Potlife Remaining register contains the current amount of time remaining in the active recipe's potlife in seconds.

**NOTE:** If potlife is disabled for the active recipe or at initial startup this value will be 0xFFFFFFFF.

## OUTPUT REGISTER 05: Gun 1 Trigger Input Status OUTPUT REGISTER 31: Gun 2 Trigger Input Status

The Gun Trigger Input Status registers contain the status of the Gun Trigger Discrete Inputs.

- The value is 0 if the input is OPEN (gun not triggered).
- The value is 1 if the input is CLOSED (gun triggered).

This data register is valid only for systems configured to use the discrete inputs for the Gun Triggers. See [Gun Trigger Signal, page 71](#).

## OUTPUT REGISTERS 06: Pump 1 Status OUTPUT REGISTERS 07: Pump 2 Status OUTPUT REGISTERS 32: Pump 3 Status OUTPUT REGISTERS 33: Pump 4 Status

The Pump Status registers contain a number that indicates the state of Pumps 1 – 4. This status can be used for general monitoring of the pump state, or as an indicator for driving independent pump operations. See [INPUT REGISTER 06 and 16: Flush/Prime Pump Command, page 37](#).

**Table 4 Pump States for Output Registers 06, 07, 32, and 33**

Number	Pump State	Description
0	Off	The pump is powered down or not enabled.
1	Standby	The pump is powered but not currently active.
2	Busy	The pump is currently in a recipe change or mixing operation.
3	Flushing	The pump is currently flushing with solvent
4	Priming	The pump is currently priming with material.

## OUTPUT REGISTER 08: Pump 1 Material OUTPUT REGISTER 09: Pump 2 Material OUTPUT REGISTER 34: Pump 3 Material OUTPUT REGISTER 35: Pump 4 Material

The Pump Material register values indicate what material is currently loaded in each pump.

- Colors are numbered 1 – 32.
- Catalysts are numbered 33 – 40.
- The value is 0 if the pump is filled with solvent.
- The value is 61 if the material is unknown, such as initial startup.

**OUTPUT REGISTER 10: Actual Pump 1 Flow Rate**

**OUTPUT REGISTER 11: Actual Pump 2 Flow Rate**

**OUTPUT REGISTER 36: Actual Pump 3 Flow Rate**

**OUTPUT REGISTER 37: Actual Pump 4 Flow Rate**

These registers contain the instantaneous flow rate of Pumps 1–4 in cc/min.

This is **NOT** the mix flow rate. For mix flow rate see *Actual Mix Flow*.

**OUTPUT REGISTER 12: Actual Pump 1 Fluid Pressure**

**OUTPUT REGISTER 13: Actual Pump 2 Fluid Pressure**

**OUTPUT REGISTER 38: Actual Pump 3 Fluid Pressure**

**OUTPUT REGISTER 39: Actual Pump 4 Fluid Pressure**

These registers contain the instantaneous fluid pressure on the outlet of pumps 1–4 in PSI.

**OUTPUT REGISTER 14 and 40: Active Recipe Number**

The Active Recipe Number register contains the number of the active recipe (1 – 30).

- This value is 0 if the Mix Unit was flushed.
- This value is 61 if the Mix Unit does not know the current loaded recipe, if the recipe is invalid, or at initial startup.

**OUTPUT REGISTER 15 and 41: Active Recipe Material A**

The Active Recipe Material A register contains the number of the Color (1 – 32) that is associated with the current recipe.

- This value is 0 if the Mix Unit was flushed.
- This value is 61 if the current recipe is invalid or at initial startup.

**OUTPUT REGISTER 16 and 42: Active Recipe Material B**

The Active Recipe Material B data register contains the number of the Catalyst (33 – 40) that is associated with the current recipe.

- This value is 0 if the Mix Unit was flushed.
- This value is 61 if the current recipe is invalid or at initial startup.
- This value is 0 if the current recipe ratio is 0:1 (1K recipe).

**OUTPUT REGISTER 17 and 43: Active Recipe Material A Flush Sequence**

The Active Recipe Material A Flush Sequence register contains the number of the Flush Sequence (1 – 5) that is associated with the Color pump of the current recipe.

If the current recipe is invalid this value reflects the Flush Sequence associated with Material A pump of recipe 0.

**OUTPUT REGISTER 18 and 44: Active Recipe Material B Flush Sequence**

The Active Recipe Material B Flush Sequence register contains the number of the Flush Sequence (1 – 5) that is associated with the Catalyst pump of the current recipe.

- If the current recipe is invalid this value reflects the Flush Sequence associated with Material B pump of recipe 0.
- This value is 0 if the current recipe ratio is 0:1 (1K recipe).

**OUTPUT REGISTER 19 and 45: Active Recipe Ratio Set Point**

The Active Recipe Ratio Set Point data register contains the ratio set point associated with the current recipe.

- The value reported is the ratio antecedent multiplied by 100. The ratio consequent is always 1.

*Example:* Value = 250 >> A mix ratio of 2.5:1 (Material A to Material B)

- This value is 0 if the current recipe ratio is 0:1 (1K recipe).

### **OUTPUT REGISTER 20 and 46: Active Recipe Potlife Timeout Set Point**

The Active Recipe Potlife Timeout Set Point register contains the set point for the potlife time associated with the current recipe in minutes.

- This value is 0 if the potlife time is disabled for the current recipe.

### **OUTPUT REGISTER 21 and 47: Job Number**

The Job Number register contains the number of the job currently running on the Mix Unit.

### **OUTPUT REGISTER 22 and 48: Job A Sprayed Volume**

The Job A Sprayed Volume register provides a real time volume of color sprayed during the current job in cc.

### **OUTPUT REGISTER 23 and 49: Job B Sprayed Volume**

The Job B Sprayed Volume register provides a real time volume of color sprayed during the current job in cc.

### **OUTPUT REGISTER 24 and 50: Job Solvent Volume**

The Job Solvent Volume register provides a real time volume of solvent dispensed during the current job in cc.

### **OUTPUT REGISTER 25 and 51: Safety Interlock Input Status**

The Safety Interlock Input Status register contains the status of the Safety Interlock Discrete Input.

- The value will be 0 if the input is OPEN (Normal).
- The value will be 1 if the input is CLOSED (Safety Stop).

*See [Safety Interlock in Digital Inputs, page 24](#).*

### **OUTPUT REGISTERS 52 – 61: DCS Command Structure**

See [Dynamic Command Description, page 50](#).

**Network Output Data Map (Read Only)**

Network Output ID	Modbus Register	Parameter Name	Data Type	Units	Range
0000	41000	Current System Mode	uint32	NONE	1 = Pump Off 2 = Color Change 3 = Color Change: Purge A 4 = Color Change: Purge B 5 = Color Change: Fill 6 = Mix Fill 7 = Mix 8 = Mix Idle 9 = Purge A 10 = Purge B 11 = Standby: Mix Ready 12 = Standby: Fill Ready 13 = Standby: Mix Not Ready 14 = Standby: Alarm 15 = Line Filling/Flushing 16 = Pump Prime/Flush 17 = Maintenance/Calibration
0001	41002	Event Flag	uint32	NONE	0 = No Events 1 = New Event
0002	41004	Actual Mix Flow/Pressure	uint32	cc/min PSI	1 – 1600
0003	41006	Actual Mix Ratio	uint32	NONE	0 – 5000
0004	41008	Actual Mix Potlife Remaining	uint32	sec	0 – 59940
0005	41010	Gun 1 Trigger Status	uint32	NONE	0 = Gun not triggered 1 = Gun triggered
0006	41012	Pump 1 Status	uint32	NONE	0 = Off 1 = Standby 2 = Busy 3 = Flushing 4 = Priming
0007	41014	Pump 2 Status	uint32	NONE	0 = Off 1 = Standby 2 = Busy 3 = Flushing 4 = Priming
0008	41016	Pump 1 Material	uint32	NONE	0 – 40, 61
0009	41018	Pump 2 Material	uint32	NONE	0 – 40, 61
0010	41020	Actual Pump 1 Flow Rate	uint32	cc/min	0 – 800

Operation Using a Programmable Logic Controller (PLC)

Network Output ID	Modbus Register	Parameter Name	Data Type	Units	Range
0011	41022	Actual Pump 2 Flow Rate	uint32	cc/min	0 – 800
0012	41024	Actual Pump 1 Fluid Pressure	uint32	PSI	0 – 1500
0013	41026	Actual Pump 2 Fluid Pressure	uint32	PSI	0 – 1500
0014	41028	Active Recipe Number	uint32	NONE	0 – 30, 61
0015	41030	Active Recipe Material A	uint32	NONE	1 – 32, 61
0016	41032	Active Recipe Material B	uint32	NONE	33 – 40, 61
0017	41034	Active Recipe Material A Flush Sequence	uint32	NONE	1 – 5
0018	41036	Active Recipe Material B Flush Sequence	uint32	NONE	1 – 5
0019	41038	Active Recipe Ratio Set Point	uint32	NONE	0 – 5000
0020	41040	Active Recipe Potlife Time Set Point	uint32	min	0 – 999
0021	41042	Job Number	uint32	NONE	0 – 9999
0022	41044	Job A Sprayed Volume	uint32	cc	0 – 999999999
0023	41046	Job B Sprayed Volume	uint32	cc	0 – 999999999
0024	41048	Job Solvent Volume	uint32	cc	0 – 999999999
0025	41050	Safety Interlock Input Status	uint32	NONE	0 = Open 1 = Closed
0026	42000	Current System Mode	uint32	NONE	1 = Pump Off 2 = Color Change 3 = Color Change: Purge A 4 = Color Change: Purge B 5 = Color Change: Fill 6 = Mix Fill 7 = Mix 8 = Mix Idle 9 = Purge A 10 = Purge B 11 = Standby: Mix Ready 12 = Standby: Fill Ready 13 = Standby: Mix Not Ready 14 = Standby: Alarm 15 = Line Filling/Flushing 16 = Pump Prime/Flush 17 = Maintenance/Calibration
0027	42002	Event Flag	uint32	NONE	0 = No Events 1 = New Event



Operation Using a Programmable Logic Controller (PLC)

Network Output ID	Modbus Register	Parameter Name	Data Type	Units	Range
0028	42004	Actual Mix Flow/Pressure	uint32	cc/min or PSI	1 – 1600
0029	42006	Actual Mix Ratio	uint32	NONE	0 – 5000
0030	42008	Actual Mix Potlife Remaining	uint32	sec	0 – 59940
0031	42010	Gun 2 Trigger Status	uint32	NONE	0 = Gun not triggered 1 = Gun triggered
0032	42012	Pump 3 Status	uint32	NONE	0 = Off 1 = Standby 2 = Busy 3 = Flushing 4 = Priming
0033	42014	Pump 4 Status	uint32	NONE	0 = Off 1 = Standby 2 = Busy 3 = Flushing 4 = Priming
0034	42016	Pump 3 Material	uint32	NONE	0 – 40, 61
0035	42018	Pump 4 Material	uint32	NONE	0 – 40, 61
0036	42020	Actual Pump 3 Flow Rate	uint32	cc/min	0 – 800
0037	42022	Actual Pump 4 Flow Rate	uint32	cc/min	0 – 800
0038	42024	Actual Pump 3 Fluid Pressure	uint32	PSI	0 – 1500
0039	42026	Actual Pump 4 Fluid Pressure	uint32	PSI	0 – 1500
0040	42028	Active Recipe Number	uint32	NONE	0 – 30, 61
0041	42030	Active Recipe Material A	uint32	NONE	1 – 32, 61
0042	42032	Active Recipe Material B	uint32	NONE	33 – 40, 61
0043	42034	Active Recipe Material A Flush Sequence	uint32	NONE	1 – 5
0044	42036	Active Recipe Material B Flush Sequence	uint32	NONE	1 – 5
0045	42038	Active Recipe Ratio Set Point	uint32	NONE	0 – 5000
0046	42040	Active Recipe Potlife Time Set Point	uint32	min	0 – 999
0047	42042	Job Number	uint32	NONE	0 – 9999
0048	42044	Job A Sprayed Volume	uint32	cc	0 – 999999999
0049	42046	Job B Sprayed Volume	uint32	cc	0 – 999999999
0050	42048	Job Solvent Volume	uint32	cc	0 – 999999999

Operation Using a Programmable Logic Controller (PLC)

Network Output ID	Modbus Register	Parameter Name	Data Type	Units	Range
0051	42050	Safety Interlock Input Status	unit32	NONE	0 = Open 1 = Closed
0052	43000	Command Return 1	unit32	NONE	N/A
0053	43002	Command Return 2	unit32	NONE	N/A
0054	43004	Command Return 3	unit32	NONE	N/A
0055	43006	Command Return 4	unit32	NONE	N/A
0056	43008	Command Return 5	unit32	NONE	N/A
0057	43010	Command Return 6	unit32	NONE	N/A
0058	43012	Command Return 7	unit32	NONE	N/A
0059	43014	Command Return 8	unit32	NONE	N/A
0060	43016	Command Return 9	unit32	NONE	N/A
0061	43018	Command Acknowledgment	unit32	NONE	0 = NOP 1 = BUSY 2 = ACK 3 = NAK 4 = ERR

 DCS Registers

## ProMix PD2K Network Inputs

The ProMix PD2K Network Inputs are Write-Read capable, but should be treated as outputs from a PLC or other networking device. These registers allow the user to control system operation and configure system settings remotely. Invalid values (i.e. out of bounds or not consistent with system configuration) will be ignored by the ProMix PD2K. All values must be written as integers. Floating point numbers are not supported.

Do not rely on these registers for Read status, other than to confirm data that has been written and accepted.

**NOTE:** The PD2K system does not refresh the values for these registers. At power up all input registers initialize to invalid values.

### INPUT REGISTER 00 and 10: System Mode Command

The System Mode Command register accepts a number that represents a command to the PD2K system to initiate a particular operation. Some operation modes may be initiated only under certain conditions (see Figures 5 – 9 for details).

Input Value	Operation Mode	Description
0	No OP	The Mix Unit takes no action.
1	Power Pumps	The Mix Unit powers on or powers off the pumps.
2	Remote Stop	The Mix Unit stops all current operations and turns off power to the pumps.
3	Recipe Change	The Mix Unit initiates a recipe change. (See also Input Register 02 and 12..)
4	Mix Fill	The Mix Unit fills the mix manifold and gun with material at ratio for a valid recipe.
5	Mix	The Mix Unit initiates a mix/spray cycle.
6	Purge A	The Mix Unit purges only Material A out through the gun.
7	Purge B	The Mix Unit purges only Material B out through the gun.
8	Standby	The Mix Unit puts both active pumps into Standby mode.
9	Recipe Purge	The Mix Unit automatically determines the purge sequence required based on the loaded recipe.

### INPUT REGISTER 01 and 11: Clear Active Alarm/Deviation

The Clear Active Alarm/Deviation register is used to remotely acknowledge a system error. The Event Flag register indicates whether a system error requiring acknowledgement exists (see [OUTPUT REGISTER 01 and 27: Event Flag, page 28](#)). In the case of an alarm condition, the alarm must be acknowledged and resolved before the Mix Unit is allowed to resume operation. Write a '1' to this register to acknowledge the latest active system error. If more than one system error is currently active, only the most recent will be acknowledged.

A repeated write should be performed to clear any remaining active system errors.

(See [System Errors, page 97](#) for more information on alarms and deviations.)

**NOTE:** This register is not polled by the ProMix PD2K. A system error is cleared only when a value of '1' is written to this register. It is recommended that the automation reset this register by writing a '0' to it at all other times to avoid inadvertently clearing an alarm.\*

\* It is recommended to wait at least 500 msec for the PD2K to process before resetting to '0'.

## INPUT REGISTER 02 and 12: Go To Recipe Number

The Go to Recipe Number register is used as a queue for the next recipe to be loaded when a recipe change is initiated. A number between 0 and 30 can be written to this register. However, a recipe must be enabled via the ADM before it can be loaded. See [Recipe Screen, page 74](#).

**NOTE:** Writing to this register does not trigger a recipe change. See [Color Change Sequence, page 46](#).

## INPUT REGISTER 03 and 13: Mix Control Set Point

The Mix Control Set Point register is used to set and adjust the mixing fluid control set point. It can be changed at any time, and the system will immediately adjust to the new set point.

- If the Mix Unit is configured for Flow Control this value can be set between 5 and 1600 cc/min for a 2K recipe, and between 5 and 800 for a 1K recipe. See Fluid Control on [System Screen 4, page 71](#).
- If the Mix Unit is configured for Pressure Control this value can be set between 0 and the maximum pump pressure in PSI. See Fluid Control on [System Screen 4, page 71](#).

**NOTE:** The Flow Control must be configured to 'Network' via System Screen 4 on the ADM. If set to 'Discrete' this register is ignored and set point adjustment is handled via the discrete input. See [Analog Inputs, page 24](#).

## INPUT REGISTER 04 and 14: Mix Fill Set Point

The Mix Fill Set Point register is used to set an alternate control set point during the mix fill process (see Mix Fill Set Point on [System Screen 2, page 69](#)).

- If the Mix Unit is configured for Flow Control this value can be set between 5 and 1600 cc/min for a 2K recipe, and between 5 and 800 for a 1K recipe. See Fluid Control on [System Screen 4, page 71](#).
- If the Mix Unit is configured for Pressure Control this value can be set between 1 and the maximum pump pressure in PSI. See Fluid Control on [System Screen 4, page 71](#).

**NOTE:** The Flow Control must be configured to 'Network' via System Screen 4 on the ADM. If set to 'Discrete' this register is ignored and set point is handled via the discrete input. See [Analog Inputs, page 24](#).

## INPUT REGISTER 05 and 15: Pump Flush Sequence/Prime Material Selection

The Pump Flush Sequence/Prime Material Selection register is used in conjunction with the Flush/Prime Pump Command register (see [INPUT REGISTER 06 and 16: Flush/Prime Pump Command, page 37](#)) to independently prime or flush an inactive pump.

- Write a value between 1 and 5 if flushing a pump.
- Write a value between 1 and 32 if priming a Color pump.
- Write a value between 33 and 40 if priming a Catalyst pump.

**NOTE:** It is important that the user know which material is assigned to each pump. An invalid selection will be ignored by the ProMix PD2K.

## INPUT REGISTER 06 and 16: Flush/Prime Pump Command

The Flush/Prime Pump Command register is used in conjunction with the Pump Flush Sequence/Prime Material Selection register (see INPUT REGISTER 05 and 15) to independently prime or flush an inactive pump. The desired pump MUST be in Standby mode. Confirm by reading the corresponding Pump Status output register (see OUTPUT REGISTERS 06, 07, 32, and 33).

Material Selection register then the Flush/Prime command will be ignored. The user must know what material is assigned to each pump. (See Color Change Kits Instruction Manual 332455 for color/catalyst pump mapping.)

This register can also be used to fill or flush a specific material hose.

If an invalid Flush Sequence or invalid material number is written to the Pump Flush Sequence/Prime

Input Value	Operation Mode	Description
0	No OP	The system takes no action.
1	Flush Pump 1	Flush Pump 1 using selected sequence.
2	Prime Pump 1	Prime Pump 1 using selected material.
3	Flush Pump 2	Flush Pump 2 using selected sequence.
4	Prime Pump 2	Prime Pump 2 using selected material.
5	Flush Pump 3	Flush Pump 3 using selected sequence.
6	Prime Pump 3	Prime Pump 3 using selected material.
7	Flush Pump 4	Flush Pump 4 using selected sequence.
8	Prime Pump 4	Prime Pump 4 using selected material.
9	Fill Line	Run selected material from the pump and out the gun.
10	Flush Line	Run solvent through hoses for selected material from the pump and out the gun.
11	Stop Line Fill/Flush	Stop Line Fill/Flush command.

## INPUT REGISTER 07 and 17: Job Complete

The Job Complete register is used to log the current job remotely. Write a '1' to the register to command the ProMix PD2K to flag a job complete.

(See [Usage Screen, page 66](#) for more information on Job Logs and Job Complete.)

**NOTE:** This register is not polled by the ProMix PD2K. A job is logged only when a value of '1'

is written to this register. It is recommended the automation reset this register by writing a '0' to it at all other times to avoid inadvertently logging a job.\*

\* It is recommended to wait at least 500 msec for the PD2K to process before resetting to '0'.

**INPUT REGISTER 08: Gun 1 Trigger**  
**INPUT REGISTER 18: Gun 2 Trigger**

The Gun Trigger register is used to signal the ProMix PD2K when the automatic spray device is triggered. This signal should be sent any time the spray device is triggered. The state of this register provides timing for alarm functions and also drives the flow control algorithm.

**NOTE:** If enabled, it is imperative that this signal be sent any time the spray device is triggered. Without it the flow control features will not work.

- Write a value of '1' to signal that the gun is triggered.
- Write a value of '0' to signal that the gun is NOT triggered.

**NOTE:** This register is used only if the Gun Trigger is set to 'Network' via System Screen 4 on the ADM. If it is set to 'Discrete' this register is ignored and gun trigger is handled via the discrete input. See [Digital Inputs, page 24](#).

**NOTE:** Because timing is so critical for flow control Graco recommends that users provide a discrete input to minimize latency effects.

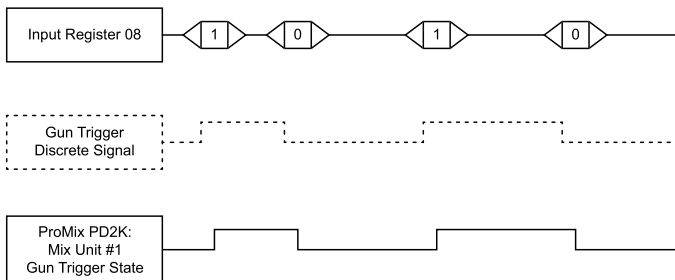

Figure 13 Gun 1 Trigger Timing (Network and Discrete Signals Shown)

**INPUT REGISTER 09 and 19: Fluid Control Mode**

The Fluid Control Mode register is used to toggle system control between Flow Control and Pressure Control (see Fluid Control on [System Screen 4, page 71](#)).

- A value of '0' sets the Mix Unit to Flow Control.
- A value of '1' sets the Mix Unit to Pressure Control.

**NOTE:** This setting is available remotely for flexibility, but typical applications will not change it.

**INPUT REGISTERS 20 – 29: DCS Command Structure**

See [Dynamic Command Description, page 50](#).

**Network Input Data Map (Write/Read)**

Network Input ID	Modbus Register	Parameter Name	Data Type	Units	Range
0000	41100	System Mode Command	uint32	NONE	0 = No OP 1 = Power Pumps 2 = Remote Stop 3 = Color Change 4 = Mix Fill 5 = Mix 6 = Purge A 7 = Purge B 8 = Standby 9 = Recipe Purge
0001	41102	Clear Active Alarm/Deviation	uint32	NONE	1 = Clear Active Alm/Dev
0002	41104	Goto Recipe Number	uint32	NONE	0, 1 – 30
0003	41106	Mix Control Set Point	uint32	cc/min PSI	1 - 1600
0004	41108	Mix Fill Set Point	unit32	cc/min or PSI	1 – 1600
0005	41110	Pump Flush Sequence #/Prime Material #	unit32	NONE	1 –5, 1 – 40
0006	41112	Flush/Prime Pump Command	unit32	NONE	0 = No OP 1 = Flush Pump 1 2 = Prime Pump 1 3 = Flush Pump 2 4 = Prime Pump 2 5 = Flush Pump 3 6 = Prime Pump 3 7 = Flush Pump 4 8 = Prime Pump 4 9 = Fill Line 10 = Flush Line 11 = Stop Line Fill/Flush
0007	41114	Job Complete	unit32	NONE	1 = Trigger job complete
0008	41116	Gun 1 Trigger	unit32	NONE	0 = Gun not triggered
					1 = Gun triggered
0009	41118	Fluid Control Mode	unit32	NONE	0 = Flow Control
					1 = Pressure Control

Operation Using a Programmable Logic Controller (PLC)

Network Input ID	Modbus Register	Parameter Name	Data Type	Units	Range
0010	42100	System Mode Command	uint32	NONE	0 = No OP 1 = Power Pumps 2 = Remote Stop 3 = Color Change 4 = Mix Fill 5 = Mix 6 = Purge A 7 = Purge B 8 = Standby 9 = Recipe Purge
0011	42102	Clear Active Alarm/Deviation	uint32	NONE	1 = Clear Active Alm/Dev
0012	42104	Goto Recipe Number	uint32	NONE	0, 1 – 30
0013	42106	Mix Control Set Point	uint32	cc/min or PSI	1 - 1600
0014	42108	Mix Fill Set Point	uint32	cc/min or PSI	1 – 1600
0015	42110	Pump Flush Sequence #/Prime Material #	uint32	NONE	1 –5, 1 – 40
0016	42112	Flush/Prime Pump Command	uint32	NONE	0 = No OP 1 = Flush Pump 1 2 = Prime Pump 1 3 = Flush Pump 2 4 = Prime Pump 2 5 = Flush Pump 3 6 = Prime Pump 3 7 = Flush Pump 4 8 = Prime Pump 4 9 = Fill Line 10 = Flush Line 11 = Stop Line Fill/Flush
0017	42114	Job Complete	uint32	NONE	1 = Trigger job complete
0018	42116	Gun 2 Trigger	uint32	NONE	0 = Gun not triggered 1 = Gun triggered
0019	42118	Fluid Control Mode	uint32	NONE	0 = Flow Control 1 = Pressure Control
0020	43100	Command Argument 1	uint32	NONE	N/A
0021	43102	Command Argument 2	uint32	NONE	N/A
0022	43104	Command Argument 3	uint32	NONE	N/A
0023	43106	Command Argument 4	uint32	NONE	N/A
0024	43108	Command Argument 5	uint32	NONE	N/A
0025	43110	Command Argument 6	uint32	NONE	N/A



Network Input ID	Modbus Register	Parameter Name	Data Type	Units	Range
0026	43112	Command Argument 7	unit32	NONE	N/A
0027	43114	Command Argument 8	unit32	NONE	N/A
0028	43116	Command Argument 9	unit32	NONE	N/A
0029	43118	Command ID	unit32	NONE	See Command Table

 DCS Registers

## Operation Flow Charts

**NOTE:** All flow charts reference registers for Mix Unit #1. For Mix Unit #2, reference the Network Maps for corresponding register indices.

### Purge Mode Sequence

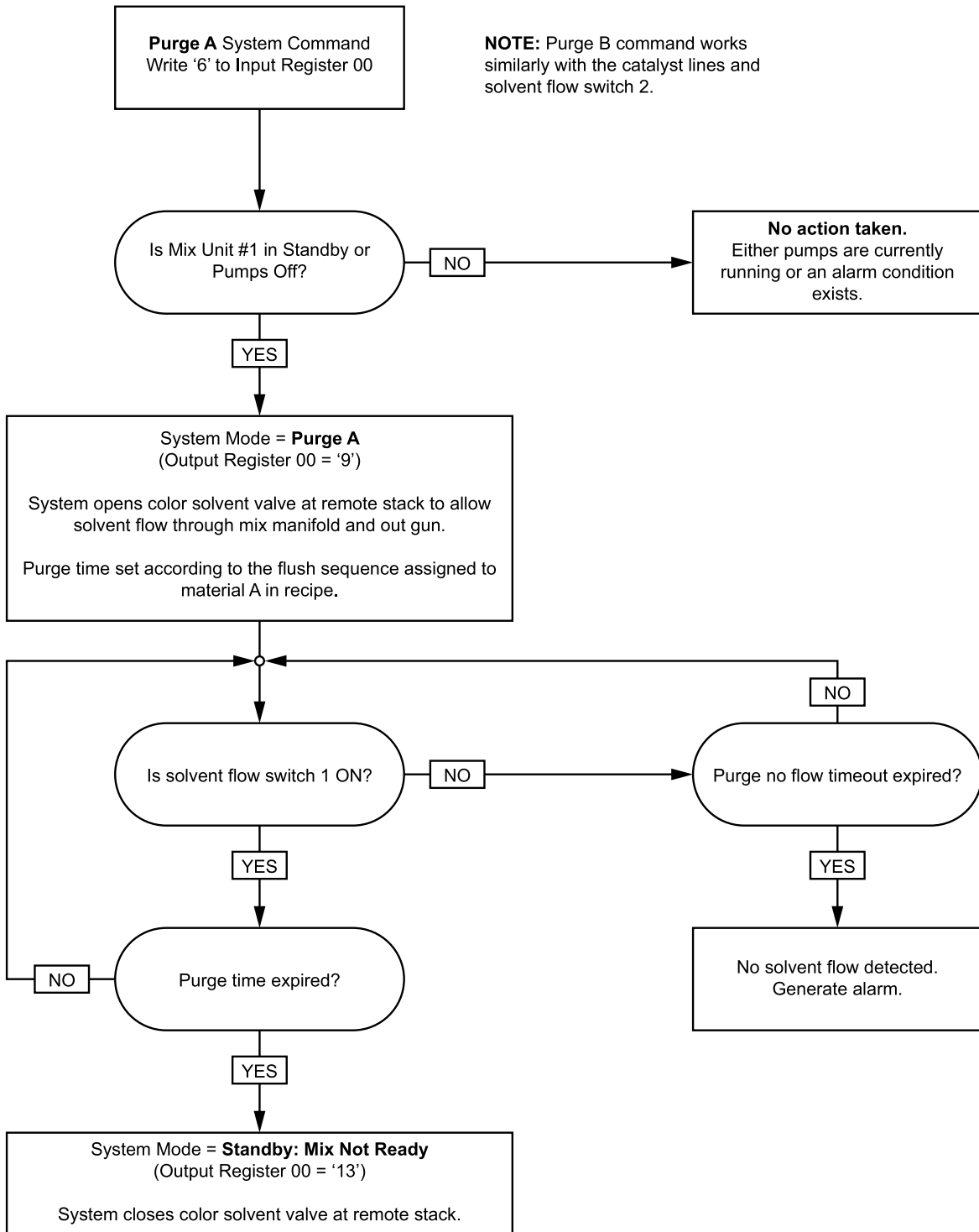

### Purge Recipe Sequence

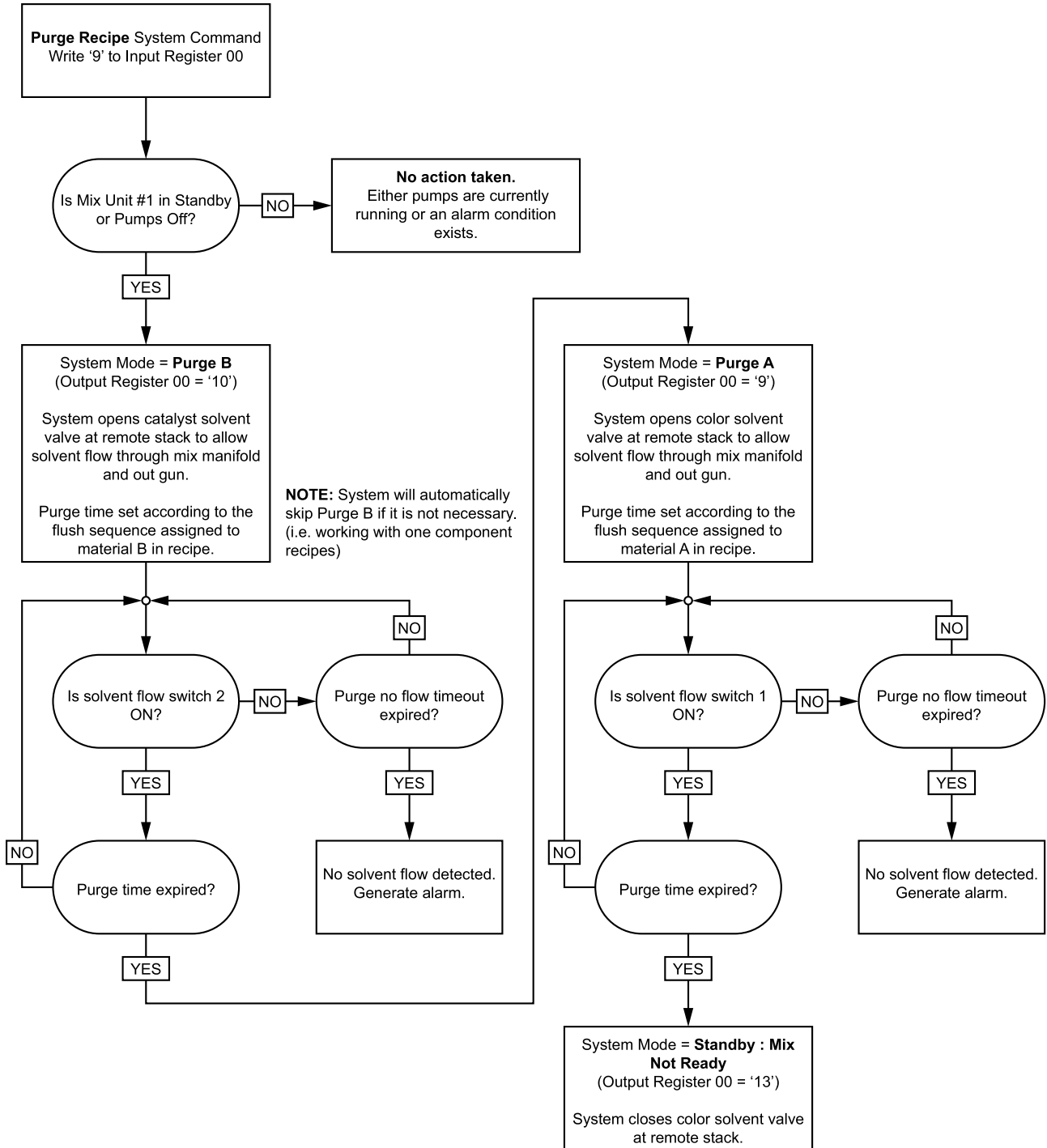

### Inactive Pump Flush and Prime Sequences

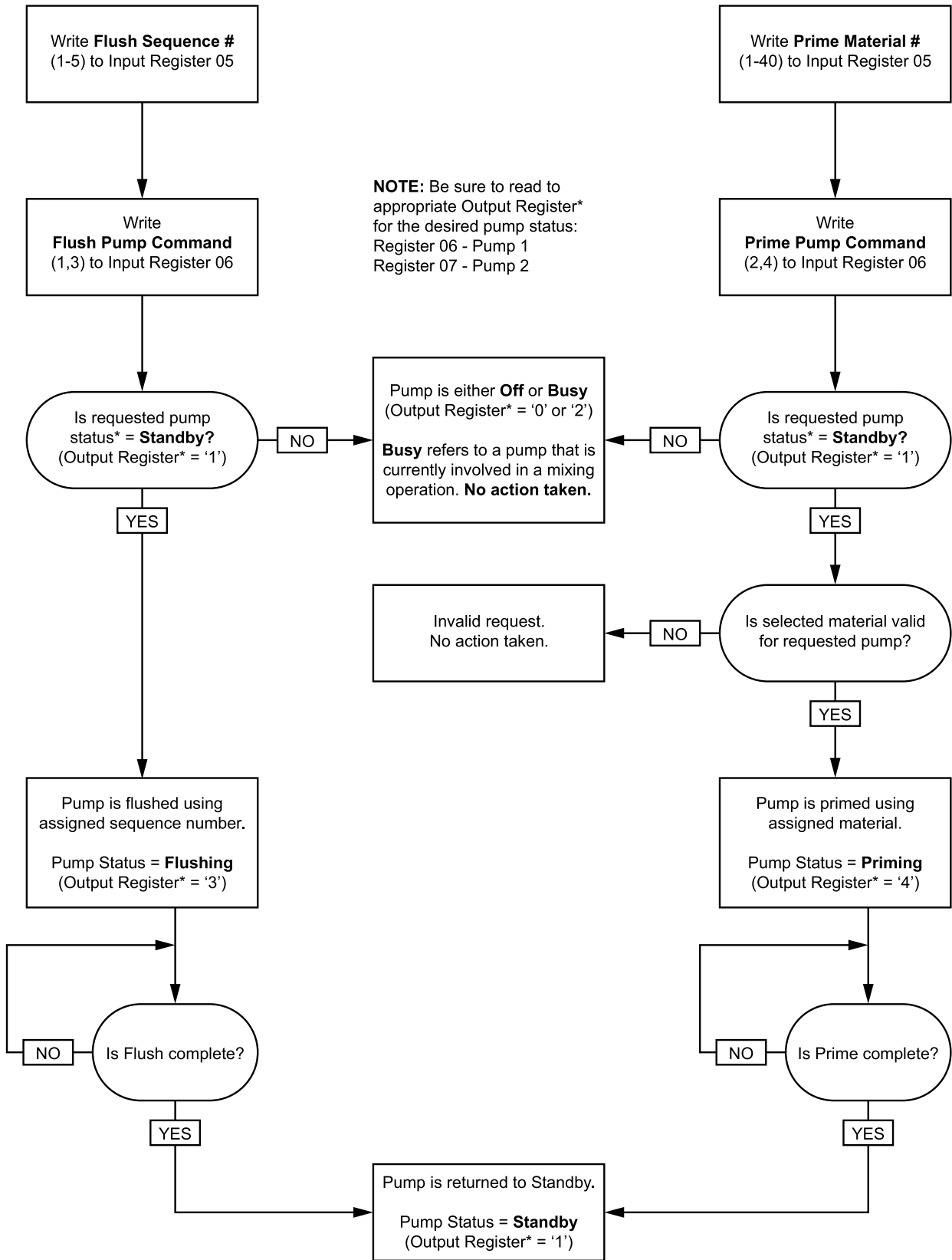

**Line Fill and Flush Sequences**

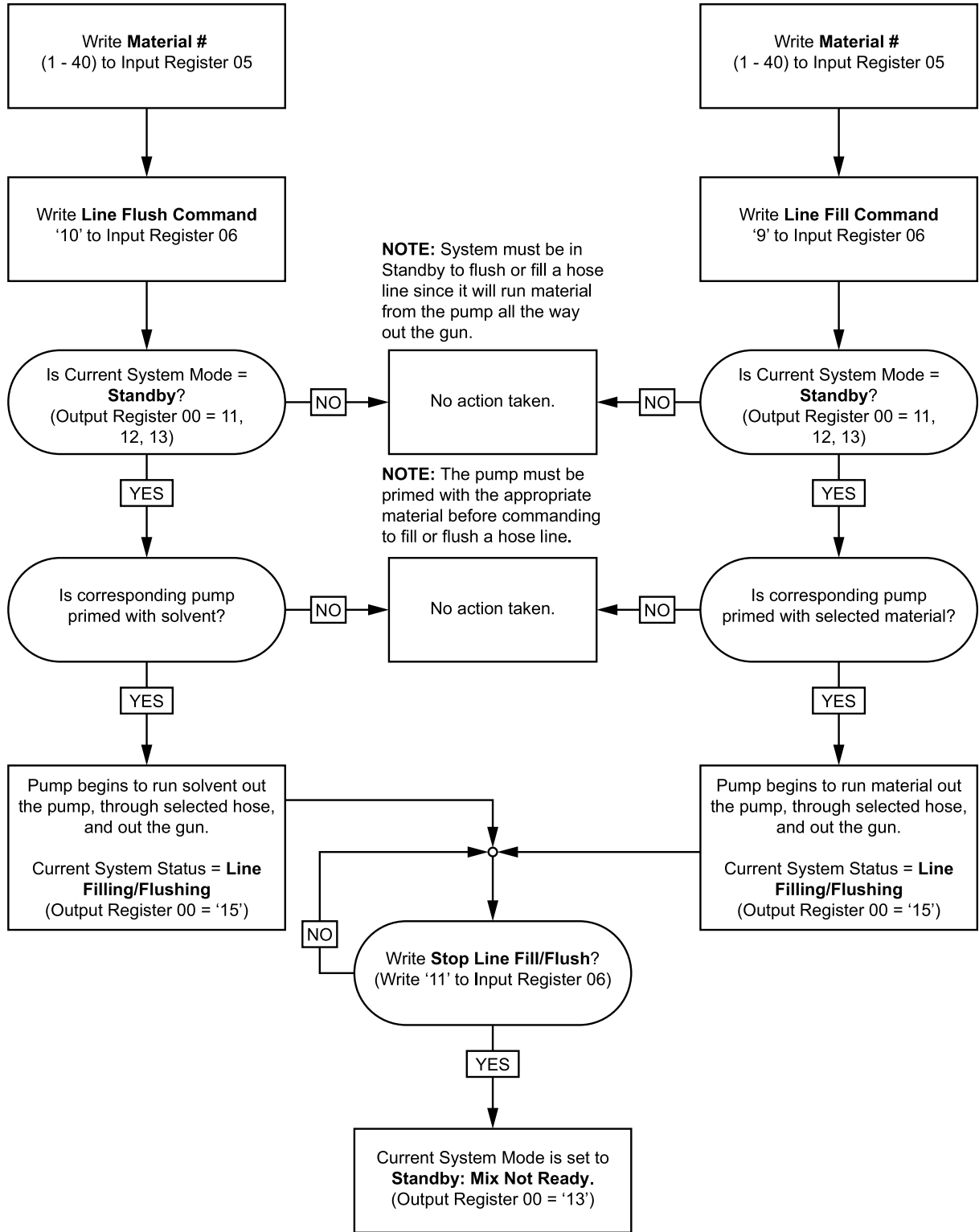

### Color Change Sequence

**NOTE:** If using Custom Mapping for color change valves, and the Inlet stack is set to Single, the Material Ready flag needs to be set prior to starting a recipe change. If the Material Ready flag is not set, the pump(s) will not fill with the designated material and the recipe change will not complete. See "Write Material Ready Flag DCS Command and Custom Valve Mapping" for more details.

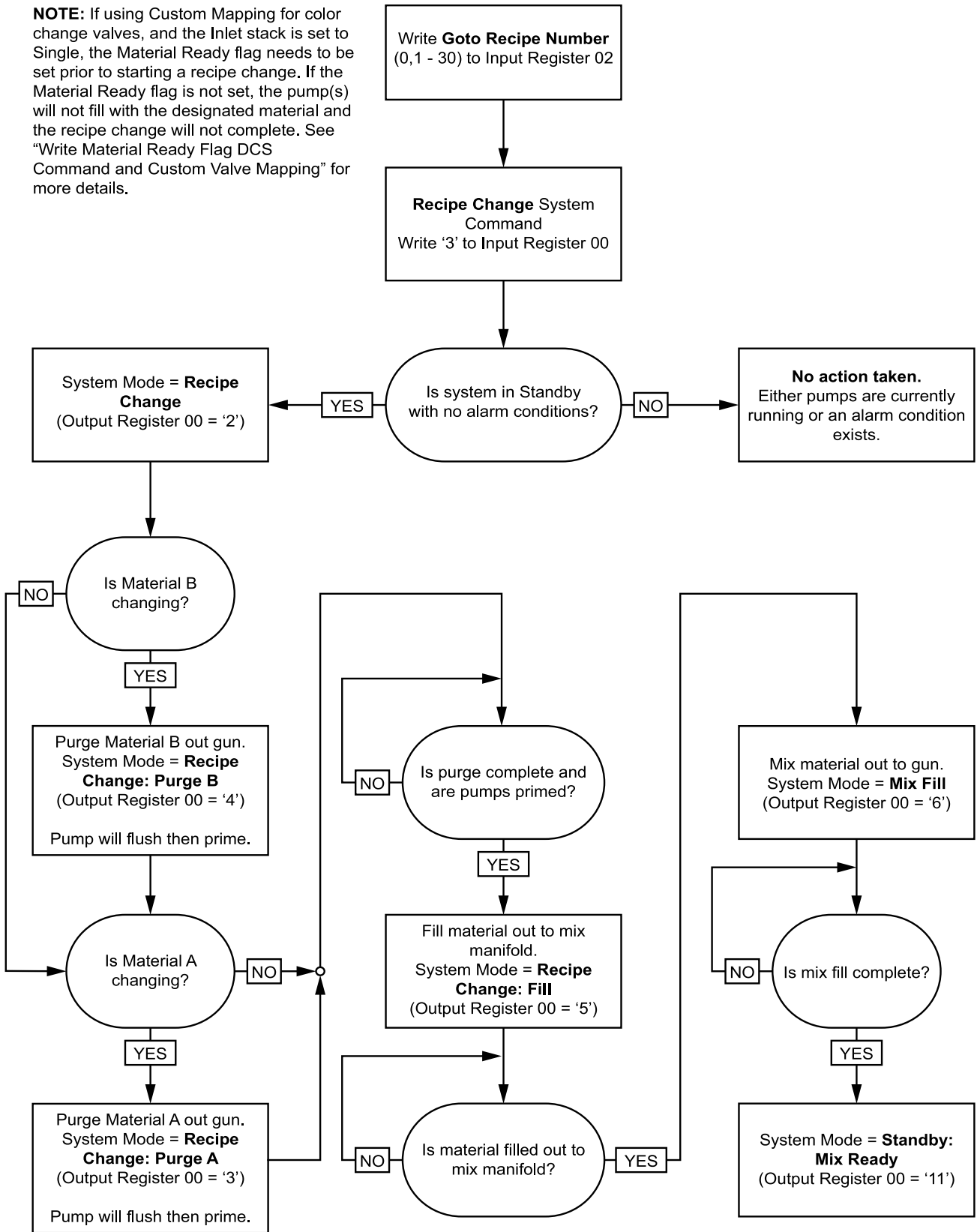

### Recipe Change Alarm Recovery Sequences

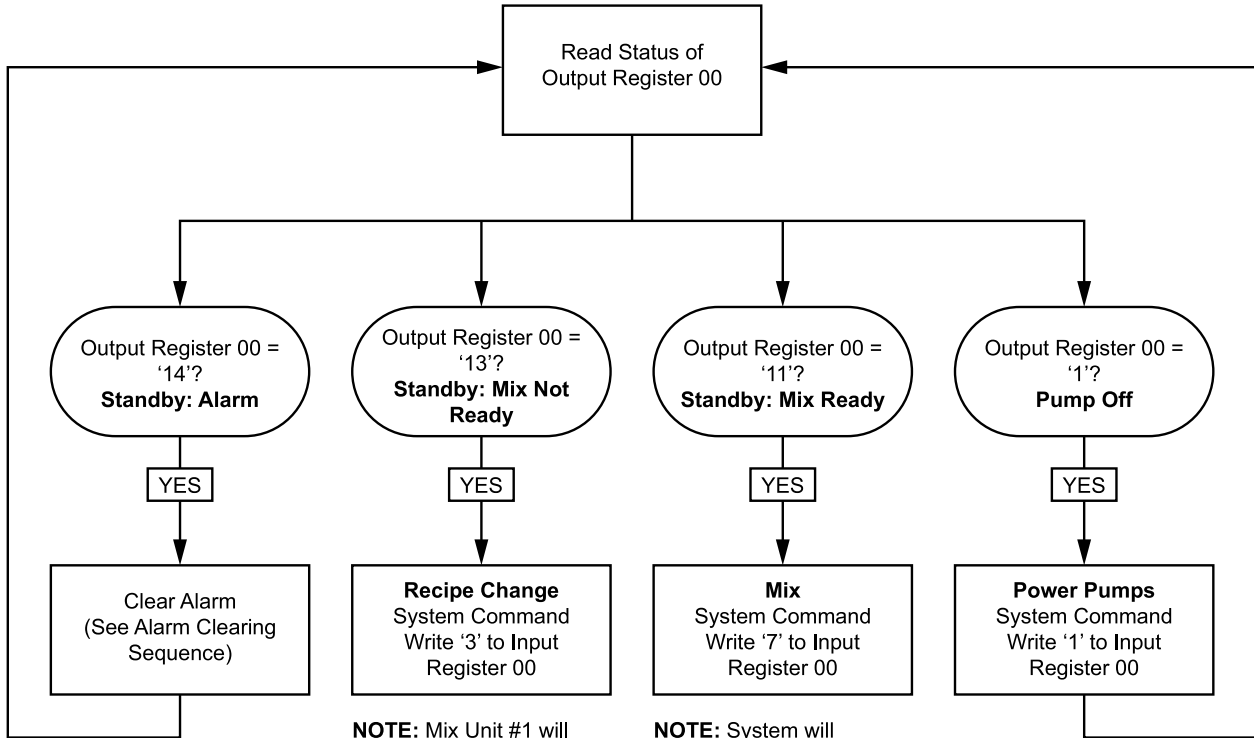

**NOTE:** Mix Unit #1 will automatically run through necessary recipe change steps based on it's current state. If **Goto Recipe Number** has not changed, it does not have to be rewritten here.

**NOTE:** System will automatically perform Mix Fill if it needs to be completed before transitioning directly into Mix mode.

### Mixing Sequence

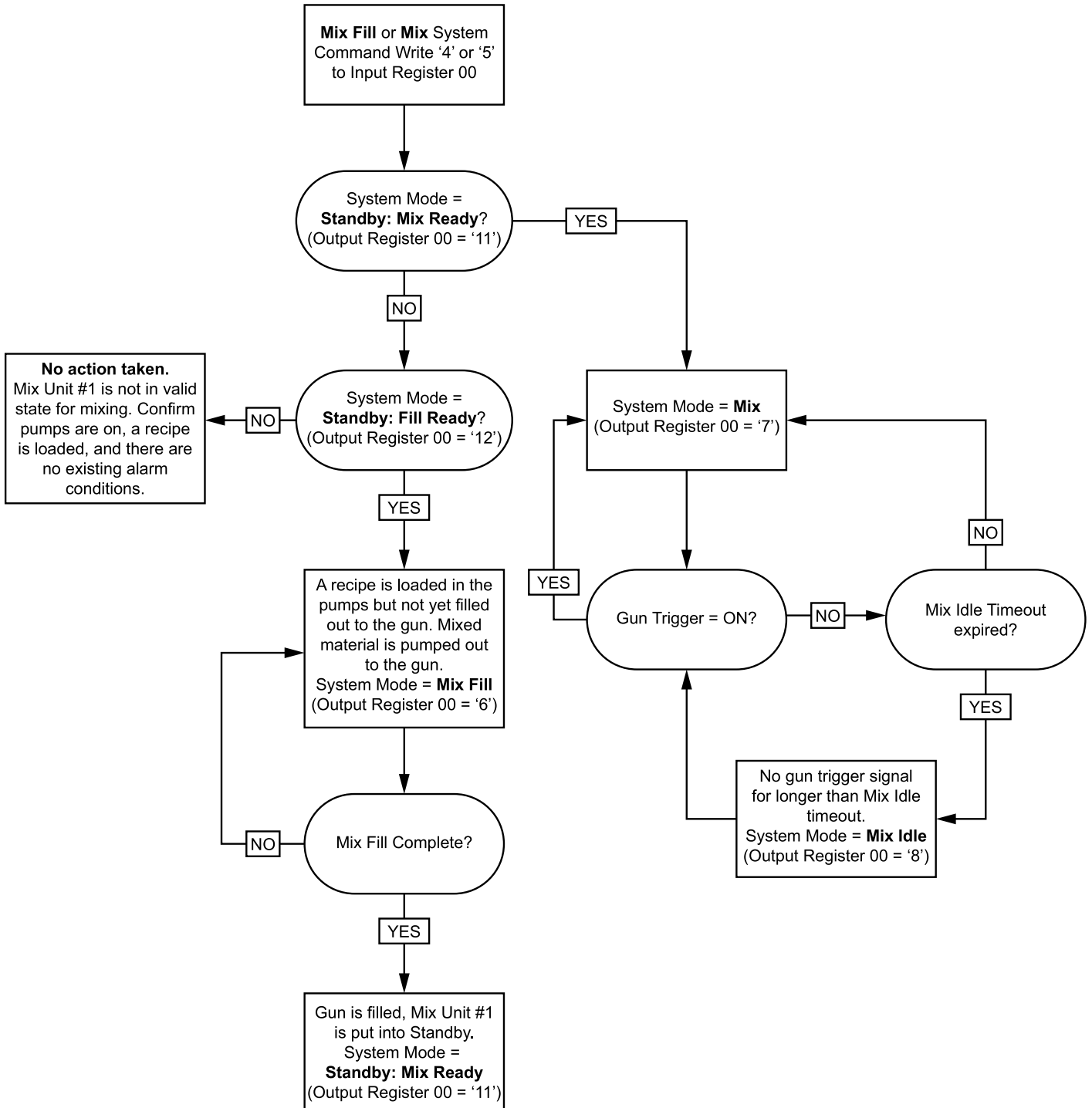



### Alarm Clearing Sequence

**NOTE:** If an alarm condition is active the System Mode will either be **Pump Off** or **Standby: Alarm** (Output Register 00 = '1' or '14'), and the Event Flag will be set (Output Register 01 = '1').

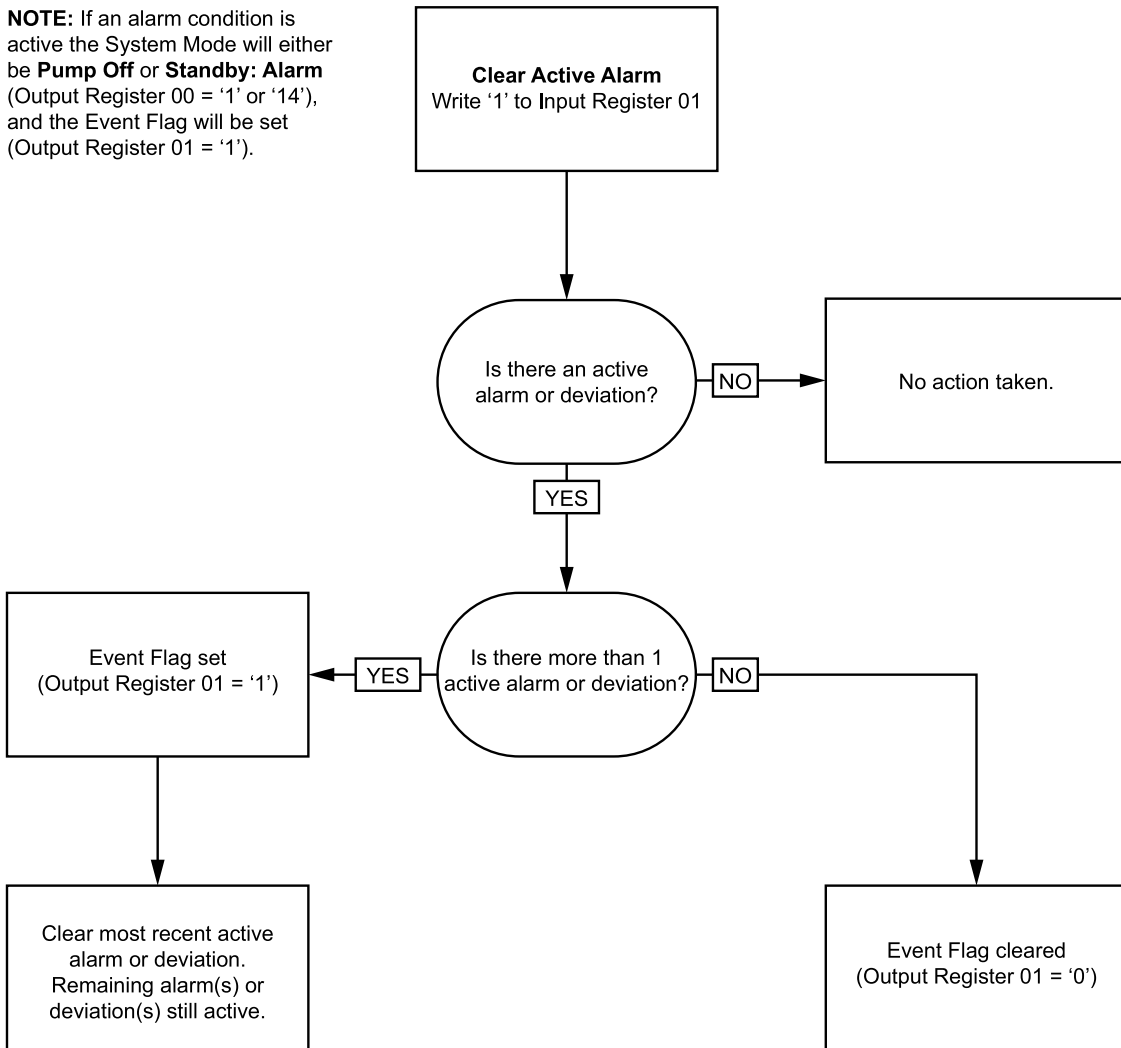

**NOTE:** If more than 1 active alarm or deviation exists a repeated write of '1' to Input Register 01 is required for each.

## Network Communication - Dynamic Command Structure (DCS)

### Dynamic Command Description

The Dynamic Command Structure (DCS) is used to 1) access data that requires some form of argument(s) or 2) consolidate data that requires multiple registers. The DCS uses a static set of network communication input and output registers (see [Network Input Data Map \(Write/Read\)](#), page 39 and [Network Output Data Map \(Read Only\)](#), page 31).

Use the following sequence for the DCS.

1. Write the appropriate command arguments to INPUT REGISTERS 20 – 28. These commands may be written sequentially or sent all at once.
2. Once all arguments have been passed, write the command ID to INPUT REGISTER 29.
3. The ProMix PD2K will respond to a valid command by writing a 2 (Acknowledge) to OUTPUT REGISTER 61.
4. The ProMix PD2K will write appropriate return values to OUTPUT REGISTERS 52 – 60.

#### ProMix PD2K Inputs (PLC Outputs)

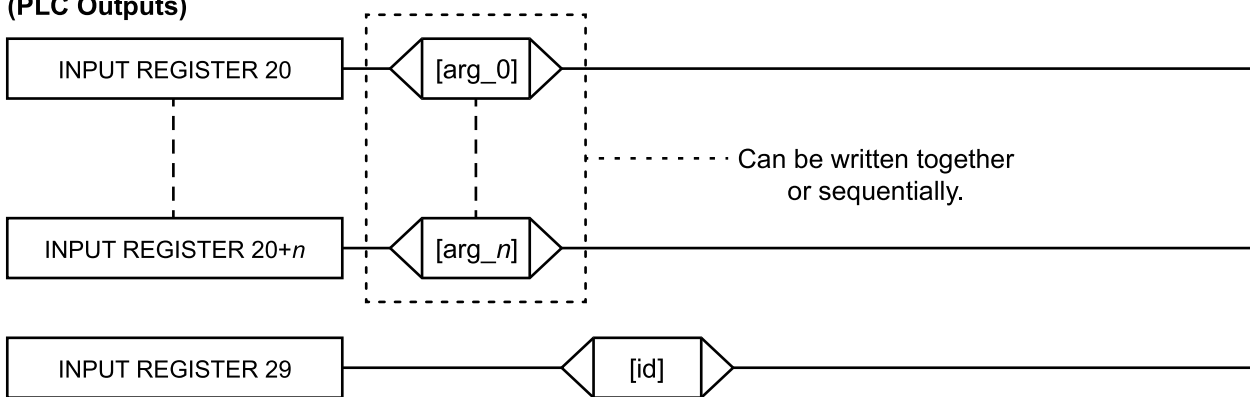

#### ProMix PD2K Outputs (PLC Inputs)

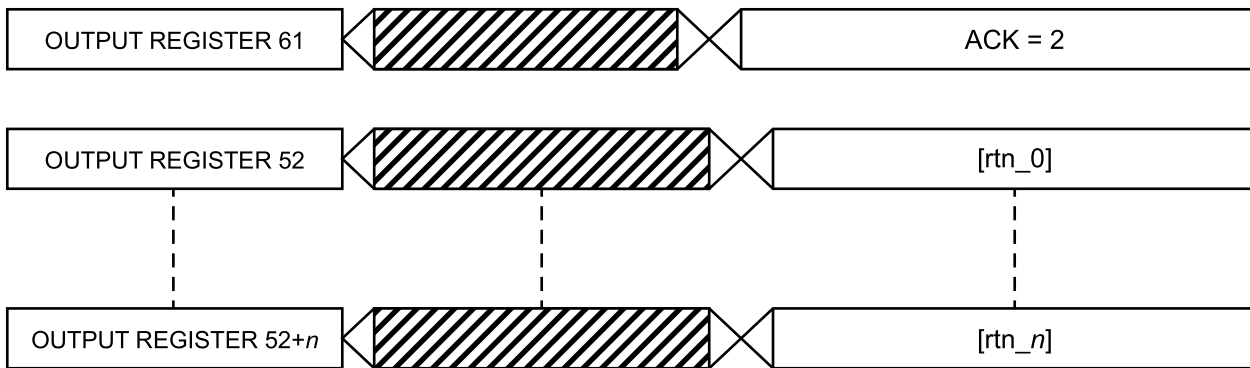

Figure 14 Dynamic Command Structure Timing

## List of DCS Commands

Table 5 Dynamic Commands with Command ID

ID	Command
0	No OP
1	Write User ID
2	Write Recipe
3	Write Flush Sequence
6	Write Material Ready Flag
10	Read User ID
11	Read Recipe
12	Read Flush Sequence
14	Read Job Info
15	Read Alarm Info
16	Read Event Info

### Write User ID

The Write User ID command allows users to assign a User ID to a Job Log. See [Usage Screen, page 66](#), for more details on Job Log and User ID. The User ID can be up to ten ASCII characters in length and is packaged as three little endian segments of ASCII characters. The return registers will echo the arguments received.

**NOTE:** The User ID character string must be terminated with a null character.

*Example: Write a User ID of "John Doe" to Mix Unit #1 of the ProMix PD2K.*

DCS Register	Parameter Description	Data Type	Units	Value	Range
DCS Command	Write User ID	uint32	NONE	1	0 - 16
Argument 0	Mix Unit	uint32	NONE	1	1 - 2
Argument 1	User ID characters [3:0] (ASCII)	uint32	NONE	0x6E686F4A = ['n', 'h', 'o', 'J']	N/A
Argument 2	User ID characters [7:4] (ASCII)	uint32	NONE	0x656F4420 = ['e', 'o', 'D', ' ']	N/A
Argument 3	User ID characters [9:8] (ASCII)	uint32	NONE	0x0 = [null]	N/A
Acknowledge	Command Acknowledged	uint32	NONE	2 = ACK	0 - 4
Return 0	Mix Unit	uint32	NONE	1	1 - 2
Return 1	User ID characters [3:0] (ASCII)	uint32	NONE	0x6E686F4A	N/A
Return 2	User ID characters [7:4] (ASCII)	uint32	NONE	0x656F4420	N/A
Return 3	User ID characters [9:8] (ASCII)	uint32	NONE	0x0	N/A

## Write Recipe

The Write Recipe command allows users to configure an entire recipe remotely. See [Recipe Screen, page 74](#), for more details on recipes and recipe parameters. The return registers will echo the arguments received.

**NOTE:** The recipe must be enabled via the ADM before it can be loaded for mixing.

**NOTE:** If a recipe is Linked, writing to a recipe will also affect the same recipe for the other Mix Unit.

*Example: Configure Mix Unit # 1 Recipe 6 for Color = 2, Catalyst = 1, Color Flush Sequence = 2, Catalyst Flush Sequence = 3, Mix Ratio Set Point = 1.50:1, Potlife = 10 minutes, and Mix Pressure Tolerance = 40%.*

DCS Register	Parameter Description	Data Type	Units	Value	Range
DCS Command	Write Recipe	uint32	NONE	2	0 - 16
Argument 0	Mix Unit	uint32	NONE	1	1 - 2
Argument 1	Recipe #	uint32	NONE	6	0 - 30
Argument 2	Material A	uint32	NONE	2	0 - 32
Argument 3	Material B	uint32	NONE	33	0, 33 - 40
Argument 4	Material A Flush Sequence	uint32	NONE	2	1 - 5
Argument 5	Material B Flush Sequence	uint32	NONE	3	1 - 5
Argument 6	Mix Ratio Set Point	uint32	NONE	150 = 1.50:1	0 - 5000
Argument 7	Potlife Time Set Point	uint32	min	10	0 - 999
Argument 8	Mix Pressure Tolerance	uint32	%	40	10 - 90
Acknowledge	Command Acknowledged	uint32	NONE	2 = ACK	0 - 4
Return 0	Mix Unit	uint32	NONE	1	1 - 2
Return 1	Recipe #	uint32	NONE	6	0 - 30
Return 2	Material A	uint32	NONE	2	0 - 32
Return 3	Material B	uint32	NONE	33	0, 33 - 40
Return 4	Material A Flush Sequence	uint32	NONE	2	1 - 5
Return 5	Material B Flush Sequence	uint32	NONE	3	1 - 5
Return 6	Mix Ratio Set Point	uint32	NONE	150	0 - 5000
Return 7	Potlife Time Set Point	uint32	min	10	0 - 999
Return 8	Mix Pressure Tolerance	uint32	%	40	10 - 90

## Write Flush Sequence

The Write Flush Sequence command allows users to configure an entire flush sequence remotely. See [Flush Screen, page 77](#), for more details of flush sequence parameters. The return registers will echo the arguments received.

*Example: Configuring Flush Sequence 4 for Gun Purge Time = 10 sec, Initial Flush Volume = 125 cc, Final Flush Volume = 250 cc, Wash Cycles = 1, Strokes per Cycle = 2.*

DCS Register	Parameter Description	Data Type	Units	Value	Range
DCS Command	Write Flush Sequence	uint32	NONE	3	0 - 21
Argument 0	Flush Sequence #	uint32	NONE	4	1 - 5
Argument 1	Gun Purge Time	uint32	NONE	10	0 - 999
Argument 2	Initial Flush Volume	uint32	NONE	125	0 - 9999
Argument 3	Final Flush Volume	uint32	NONE	250	0 - 9999
Argument 4	# Wash Cycles	uint32	NONE	1	0 - 99
Argument 5	Strokes per Wash Cycle	uint32	NONE	2	0 - 99
Acknowledge	Command Acknowledged	uint32	NONE	2 = ACK	0 - 4
Return 0	Flush Sequence #	uint32	NONE	4	1 - 5
Return 1	Gun Purge Time	uint32	sec	10	0 - 999
Return 2	Initial Flush Volume	uint32	cc	125	0 - 9999
Return 3	Final Flush Volume	uint32	cc	250	0 - 9999
Return 4	# Wash Cycles	uint32	NONE	1	0 - 99
Return 5	Strokes per Wash Cycle	uint32	NONE	2	0 - 99

## Write Material Ready Flag

The Write Material Ready Flag command is used to signal to the PD2K that the upstream material management has the appropriate color/catalyst loaded at the inlet valve stack(s) of the pump(s) prior to a recipe change. This flag is only used when multiple materials for a pump are fed to the PD2K via a single valve at the inlet valve stack (i.e. a piggyback system). See [Custom Valve Mapping, page 80](#) for more info on Single inlet valve stacks.

**NOTE:** This flag should be cleared prior to or during a material change operation upstream of the inlet valve stack to avoid having the wrong material being fed into the pump during a recipe change.

*Example: Setting the Material Ready Flag for Mix Unit #1.*

DCS Register	Parameter Description	Data Type	Units	Value	Range
DCS Command	Write Material Ready Flag	uint32	NONE	6	0 - 21
Argument 0	Mix Unit #	uint32	NONE	1	1 - 2
Argument 1	Material Ready Status	uint32	NONE	1	0 := Not Ready/No OP 1 := Material Ready
Acknowledge	Command Acknowledged	uint32	NONE	2 = ACK	0 - 4
Return 0	Mix Unit #	uint21	NONE	1	1 - 2
Return 1	Material Ready Status	uint32	NONE	1	0 := Not Ready/No OP 1 := Material Ready

## Read User ID

The Read User ID command reads back the current User ID. See [Usage Screen, page 66](#), for more details on Job Log and User ID. The User ID can be up to ten ASCII characters in length and is packaged as three little endian segments of ASCII characters. No arguments are required.

*Example: Read Mix Unit #1 User ID that is currently "John Doe".*

DCS Register	Parameter Description	Data Type	Units	Value	Range
DCS Command	Read User ID	uint32	NONE	10	0 - 16
Argument 0	Mix Unit	uint32	NONE	1	1 - 2
Acknowledge	Command Acknowledged	uint32	NONE	2 = ACK	0 - 4
Return 0	Mix Unit	uint32	NONE	1	1 - 2
Return 1	User ID characters [3:0] (ASCII)	uint32	NONE	0x6E686F4A = ['n', 'h', 'o', 'J']	N/A
Return 2	User ID characters [7:4] (ASCII)	uint32	NONE	0x656F4420 = ['e', 'o', 'D', ' ']	N/A
Return 3	User ID characters [9:8] (ASCII)	uint32	NONE	0x0 = [null]	N/A

## Read Recipe

The Read Recipe command returns all configured recipe parameters for a desired recipe number. The number of the recipe to be read is the only argument.

*Example: Read Mix Unit #1 Recipe 5 data as it is currently configured with Color = 3, Catalyst = 2 (34), Color Flush Sequence = 1, Catalyst Flush Sequence = 4, Mix Ratio Set Point = 3.25:1, Potlife = 35 min, and Mix Pressure Tolerance = 30%.*

DCS Register	Parameter Description	Data Type	Units	Value	Range
DCS Command	Read Recipe	uint32	NONE	11	0 - 16
Argument 0	Mix Unit	uint32	NONE	1	1 - 2
Argument 1	Recipe #	uint32	NONE	5	0 - 30
Acknowledge	Command Acknowledged	uint32	NONE	2 = ACK	0 - 4
Return 0	Mix Unit	uint32	NONE	1	1 - 2
Return 1	Recipe #	uint32	NONE	5	0 - 30
Return 2	Material A	uint32	NONE	3	0 - 32, 61
Return 3	Material B	uint32	NONE	34	0, 33 - 40, 61
Return 4	Material A Flush Sequence	uint32	NONE	1	1 - 5
Return 5	Material B Flush Sequence	uint32	NONE	4	1 - 5
Return 6	Mix Ratio Set Point	uint32	NONE	325	0 - 5000
Return 7	Potlife Time Set Point	uint32	min	35	0 - 999
Return 8	Mix Pressure Tolerance	uint32	%	30	10 - 90

## Read Flush Sequence

The Read Flush Sequence command returns all configured parameters for a desired flush sequence. The number of the flush sequence to be read is the only argument.

*Example: Read Flush Sequence 1 as it is currently configured with Gun Purge Time = 20 sec, Initial Flush Volume = 0 cc, Final Flush Volume = 500 cc, Wash Cycles = 2, and Strokes per Cycle = 1.*

DCS Register	Parameter Description	Data Type	Units	Value	Range
DCS Command	Read Flush Sequence	uint32	NONE	12	0 - 21
Argument 0	Flush Sequence #	uint32	NONE	1	1 - 5
Acknowledge	Command Acknowledged	uint32	NONE	2 = ACK	0 - 4
Return 0	Flush Sequence #	uint32	NONE	1	1 - 5
Return 1	Gun Purge Time	uint32	sec	20	0 - 999
Return 2	Initial Flush Volume	uint32	cc	0	0 - 9999
Return 3	Final Flush Volume	uint32	cc	500	0 - 9999
Return 4	# Wash Cycles	uint32	NONE	2	0 - 99
Return 5	Strokes per Wash Cycle	uint32	NONE	1	0 - 99

## Read Job Info

The Read Job Info command is used to access data from any of the most recent 200 job logs. The argument is the *chronological index* of the job log, where 0 is the most recent job log and 199 is the 200<sup>th</sup> most recent.

The date is returned as four-byte packet with each byte holding a two-digit value for (from MSB to LSB) year, month, day, and day of the week (Monday = 01).

The time is returned as a three-byte packet with each byte holding a two-digit value. Starting from the MSB, the first byte can be ignored, then hour, minute, and second.

**NOTE:** The argument is an index not a job number. The actual job number will, however, be one of the returned parameters. These records will match what is reported on the Jobs screen of the ADM.

(See [Usage Screen, page 66](#), for more details on Job Log)

*Example: Read back the most recent job log, job 25, which ran recipe 2 for a total of 1234 cc's of material under User ID "John Doe". The job was logged on Thursday May 29, 2014 at 11:22:14 AM with Mix Unit #1.*

DCS Register	Parameter Description	Data Type	Units	Value	Range
DCS Command	Read Job Info	uint32	NONE	14	0 - 16
Argument 0	Job Index	uint32	NONE	0	0 - 199
Acknowledge	Command Acknowledged	uint32	NONE	2 = ACK	0 - 4
Return 0	Job Date	uint32	[YY:MM:DD-:DW]	0x0E051D04 = [14:05:29:04]	N/A
Return 1	Job Time	uint32	[xx:HH:MM-:SS]	0x0B160E = [11:22:14]	N/A
Return 2	Job Number	uint32	NONE	25	0 - 9999
Return 3	Mix Unit	uint32	NONE	1	1 - 2
Return 4	Recipe #	uint32	NONE	2	0 - 30
Return 5	A+B Volume	uint32	cc	1234	N/A
Return 6	User ID [3:0] (ASCII)	uint32	NONE	0x6E686F4A = ['n', 'h', 'o', 'J']	N/A
Return 7	User ID [7:4] (ASCII)	uint32	NONE	0x656F4420 = ['e', 'o', 'D', ' ']	N/A
Return 8	User ID [9:8] (ASCII)	uint32	NONE	0	N/A



### Read Alarm Info

The Read Alarm Info command allows remote access to any of the last 200 alarms logged by the ProMix PD2K. The argument is the *chronological index* of the alarm log, where 0 is the most recent alarm and 199 is the 200<sup>th</sup> most recent.

The date is returned as a four-byte packet with each byte holding a two-digit value for (from MSB to LSB) year, month, day, and day of the week (Monday = 01).

The time is returned as a three-byte packet with each byte holding a two-digit value. Starting from the MSB, the first byte can be ignored, then hour, minute, and second.

The alarm code is a four-character little endian ASCII string

See [System Errors, page 97](#), for more details on these Event Types.

An example decoding algorithm is provided below.

*Example: Read back the second most recent alarm, which was a Position Pump 1 (DK01) recorded on Tuesday June 3, 2014 at 8:11 AM.*

DCS Register	Parameter Description	Data Type	Units	Value	Range
DCS Command	Read Alarm Info	uint32	NONE	15	0 - 16
Argument 0	Alarm Index	uint32	NONE	1	0 - 199
Acknowledge	Command Acknowledged	uint32	NONE	2 = ACK	0 - 4
Return 0	Alarm Date	uint32	[YY:MM:DD:DW]	0x0E060302 = [14:06:03:02]	N/A
Return 1	Alarm Time	uint32	[xx:HH:MM:SS]	0x080B0B = [08:11:11]	N/A
Return 2	Alarm Code Char[3:0]	uint32	NONE	0x31304B44 = ['1', '0', 'K', 'D']	N/A

#### Example ASCII Character String Decode Algorithm:

```

character_str[0] = Return_2 & 0xFF;
character_str[1] = (Return_2 >> 8) & 0xFF;
character_str[2] = (Return_2 >> 16) & 0xFF;
character_str[3] = (Return_2 >> 24) & 0xFF;
character_str[4] = '\0';
    
```

## Read Event Info

The Read Event Info command allows remote access to any of the last 200 events logged by the ProMix PD2K. The argument is the *chronological index* of the events log, where 0 is the most recent event and 199 is the 200<sup>th</sup> most recent.

The date is returned as a four-byte packet with each byte holding a two-digit value for (from MSB to LSB) year, month, day, and day of the week (Monday = 01).

The time is returned as a three-byte packet with each byte holding a two-digit value. Starting from the MSB, the first byte can be ignored, then hour, minute, and second.

The event code is a four-character little endian ASCII string.

The example decoding algorithm provided above for the Alarm Code may be used for Events equivalently.

*Example: Read back the fifth most recent event, which was a Setup Value(s) Changed (EC00) recorded on Tuesday June 3, 2014 at 8:11 AM.*

DCS Register	Parameter Description	Data Type	Units	Value	Range
DCS Command	Read Event Info	uint32	NONE	16	0 - 16
Argument 0	Event Number	uint32	NONE	4	0 - 199
Acknowledge	Command Acknowledged	uint32	NONE	2 = ACK	0 - 4
Return 0	Event Date	uint32	[YY:MM:DD-:DW]	0x0E060302 = [14:06:03:02]	N/A
Return 1	Event Time	uint32	[xx:HH:MM:SS]	0x080B0B = [08:11:11]	N/A
Return 2	Event Code Char[3:0]	uint32	NONE	0x30304345 = ['0', '0', 'C', 'E']	N/A

## PLC Diagnostic Screens

These screens may be used to verify PLC communications by providing a real-time status of all Network Inputs and Outputs.

### PLC Diagnostic Screens 1–7

These screens show all PD2K Network Outputs with their associated register ID, Modbus TCP address, current value, and any relevant state information.

09/26/16 16:53				PLC Diagnostic		Advanced	
#1 Standby				No Active Errors			
Network Outputs							
ID	Address	Value					
0	41000	13	Standby: Mix Not Ready				
1	41002	0	No Active Errors				
2	41004	0	-				
3	41006	0	-				
4	41008	4294967295	-				
5	41010	0	Off				
6	41012	1	Standby				
7	41014	1	Standby				

Figure 15 PLC Diagnostic Screen 1

### PLC Diagnostic Screens 11

This screen encapsulates all the registers used in the Dynamic Command Structure. Arguments and Command registers are shown on the left. Acknowledge and Return registers are shown on the right. When a valid DCS command is sent, the Return registers will display the appropriate data on the right side of the screen. This can be used to test and verify DCS commands with the PLC.

09/26/16 16:59						PLC Diagnostic		Advanced	
#1 Standby						No Active Errors			
ID	Address	Value	ID	Address	Value				
20	43100	0	52	43000	1				
21	43102	0	53	43002	1				
22	43104	0	54	43004	1				
23	43106	0	55	43006	33				
24	43108	0	56	43008	1				
25	43110	0	57	43010	1				
26	43112	0	58	43012	100				
27	43114	0	59	43014	0				
28	43116	0	60	43016	25				
29	43118	11	61	43018	2				

Figure 17 PLC Diagnostic Screen 11

### PLC Diagnostic Screens 8–10

These screens show all PD2K Network Inputs with their associated register ID, Modbus TCP address, last value written, and any relevant state information.

**NOTE:** If a Network Input has not been written, it will show a value of 4294967295 (0xFFFFFFFF) and state as invalid.

09/26/16 16:56				PLC Diagnostic		Advanced	
#1 Standby				No Active Errors			
Network Inputs							
ID	Address	Value					
0	41100	1	Power Pumps				
1	41102	0	-				
2	41104	1	-				
3	41106	4294967295	Invalid				
4	41108	4294967295	Invalid				
5	41110	1	-				
6	41112	2	Prime Pump				
7	41114	4294967295	Invalid				

Figure 16 PLC Diagnostic Screen 8

## Flow Control System

### Overview

Flow control is an optional feature that precisely regulates the flow of material to an automatic spray device, to help ensure adequate coverage and avoid sags or runs in the finish coat. The ProMix PD2K system can control fluid flow by directly controlling the proportioning pumps. The pumps accurately dispense a fixed volume of fluid during each stroke. For this reason, the flow rate of a given pump is directly proportional to the velocity of the pump. As long as the gun is open and the system is stable, flow control is the most effective method for controlling flow rate.

The flow control system relies on two main inputs for controlling flow rate: Gun Trigger and Control Set Point. **NOTE: These inputs are timing critical. Graco recommends that users wire them discretely to the controller.** Alternatively these two inputs can be driven by the network communications, but latency could be an issue for systems requiring precise timing.

See [System Screen 4, page 71](#), for more details on configuring these options for 'Discrete' or 'Network'.

**NOTE:** Flow control cannot be selected with a manual gun system.

### Normal Flow Control

The ProMix PD2K will directly control the speed of the pump(s) to the programmed flow control set point to maintain accurate flow rate and ratio. The flow control set point is set by Network Communications or the Discrete Input.

The system is considered to be stable when the pressure readings do not fluctuate and the flow rate is maintained. While the system is considered stable it will store ("learn") the associated pump pressures to a table that is used if the gun trigger signal is lost or removed.

### Pressure Control

When the gun trigger signal is removed the system automatically switches to pressure control mode to avoid over pressurizing the fluid lines and to allow smooth transition to flow control if the gun trigger signal returns. It also works to maintain a consistent flow rate even though it has transitioned to pressure control mode if the gun trigger signal is inadvertently lost.

### Gun On/Off Prediction

The pressure table also is used to predict if the gun has been turned on or off (without a change to the gun trigger input). The flow control system continually monitors the desired outlet pressure compared to the actual outlet pressure. If the actual pressure remains 50% or 50 psi higher than the desired pressure, whichever is larger, for longer than 10 msec, then the system predicts that the gun trigger has been released. If the actual pressure drops below the desired pressure longer than 10 msec, then the system predicts that the gun has been triggered.

The gun on/off prediction is used in the flow control algorithm to prevent the fluid pressure from becoming too high or too low due to a system disturbance. For example, if a gun off prediction occurs while the gun trigger input is high, the system will begin to control to the pressure value last stored in the pressure table for the current flow set point.

### System Startup and Defaults

The pressure table is reset for every mix cycle, or after a power cycle of the ProMix PD2K controller. This issue is not significant because the system generally is able to recalculate new pressure table values within a few seconds (depending on the stability of the fluid system).

# Run Mode Screens

**NOTE:** Selection fields and buttons that are grayed-out on the screens are not currently active.

## Opening Screen

At power up, the Graco logo will display for approximately 5 seconds, followed by the Home screen.



Figure 18 Opening Screen

## Home Screen

The Home screen displays the current status of the system. The following table details the information shown. Only one of the two Mix Units is shown as active on the Home screen (regardless of the Mix Unit's status). The active Mix Unit's pumps will appear highlighted. The other Mix Unit's pumps will be muted with an arrow icon indicating the user must toggle mix units by pressing the Up/Down Arrow key.

To view pump flow rates and pressures (as shown), select "Diagnostic Mode" on [System Screen 1, page 68](#). The Status Bar (C), Error Status (D), Solvent Gun (S), Gun Animation (T), and Recipe Information (U) apply to the active Mix Unit.

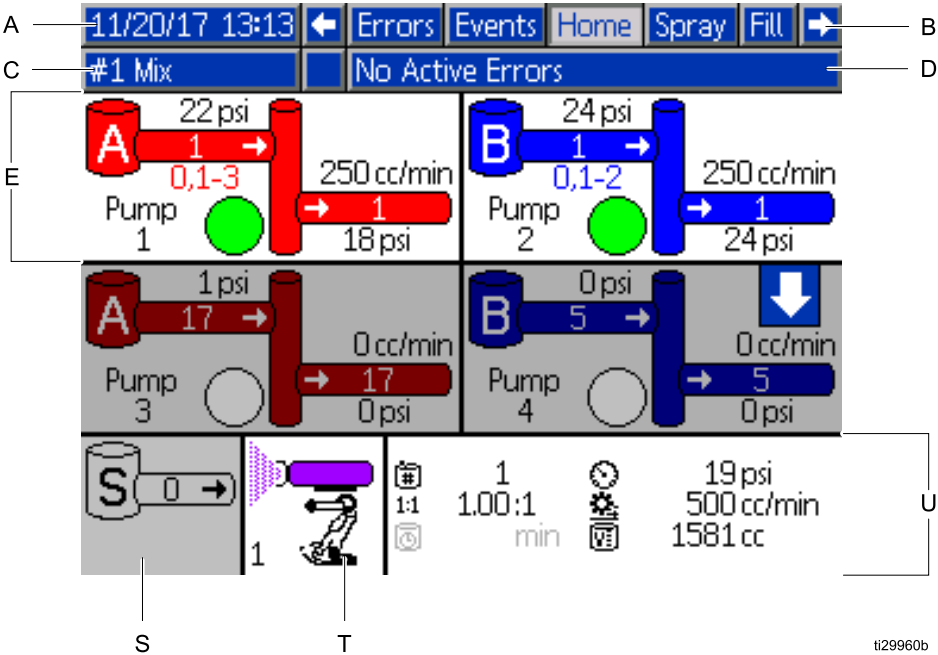

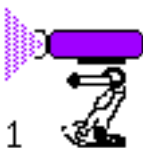





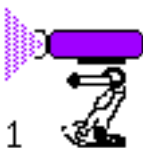





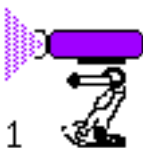





Figure 19 Home Screen, in Mix Mode with Diagnostics On

Home Screen Key

Key	Description	Details
A	Date and Time	See <a href="#">Advanced Screen 1, page 90</a> , to set.
B	Menu Bar	<p>Run Screens. Use left and right arrow keys to scroll through the different Run screens:</p> <ul style="list-style-type: none"> <li>• Home (shown in Diagnostic Mode)</li> <li>• Spray (see <a href="#">Spray Screen, page 64</a>)</li> <li>• Fill (see <a href="#">Fill Screen, page 65</a>), available only if Manual Override is enabled on <a href="#">System Screen 1, page 68</a>.</li> <li>• Usage (see <a href="#">Usage Screen, page 66</a>)</li> <li>• Jobs (see <a href="#">Jobs Screen, page 67</a>)</li> <li>• Errors (see <a href="#">Errors Screen, page 67</a>)</li> <li>• Events (see <a href="#">Events Screen, page 67</a>)</li> </ul>
C	Status Bar*	System Status: Displays the current mode of operation:
		<ul style="list-style-type: none"> <li>• Pump Off</li> <li>• Standby</li> <li>• Startup</li> <li>• Mix (Dispense in 1K Mode)</li> <li>• Mix Fill</li> <li>• Purge</li> <li>• Shutdown</li> <li>• Change Recipe</li> <li>• Idle</li> <li>• Prime Pump</li> <li>• Calibrate</li> <li>• Stall Test</li> <li>• Maintenance Test</li> </ul>
D	Error Status*	Displays any active error code.
E	Pump Animation and Diagnostic Information	
F	Pump Number (1-4)	
G	Material (A or B)	
H	Available Colors	
J	Pump Inlet Color	
L	Pump Flow Rate	
M	Pump Outlet Color	
N	Pump Outlet Pressure	
P	Pump Indicator Light	
	<ul style="list-style-type: none"> <li>• Clear = power off</li> <li>• Yellow = standby</li> <li>• Green = active</li> </ul>	
S	Solvent Flow Rate*	Shows solvent flow rate, if a solvent meter is attached.

Key	Description	Details																				
T	Spray Device Animation*	Shows mixed material in the spray device and displays active recipe at the spray device. Gun animation changes to show: <table border="1" style="width: 100%; border-collapse: collapse;"> <tr> <td style="text-align: center; vertical-align: top;">                       (Mix Fill)                 </td> <td style="text-align: center; vertical-align: top;">                       (Purge)                 </td> </tr> <tr> <td style="text-align: center; vertical-align: top;">                       (Mix With Gun Triggered)                 </td> <td style="text-align: center; vertical-align: top;">                       (Solvent Standby)                 </td> </tr> <tr> <td style="text-align: center; vertical-align: top;">                       (Recipe Standby)                 </td> <td style="text-align: center; vertical-align: top;">                       (Mix With Gun Not Triggered)                 </td> </tr> </table>	 (Mix Fill)	 (Purge)	 (Mix With Gun Triggered)	 (Solvent Standby)	 (Recipe Standby)	 (Mix With Gun Not Triggered)														
 (Mix Fill)	 (Purge)																					
 (Mix With Gun Triggered)	 (Solvent Standby)																					
 (Recipe Standby)	 (Mix With Gun Not Triggered)																					
U	Active Recipe (⊞)*	<table border="1" style="width: 100%; border-collapse: collapse;"> <tr> <td style="width: 50%;"></td> <td style="text-align: center;">V U</td> <td style="width: 50%;"></td> <td style="text-align: center;">Y Z</td> </tr> <tr> <td style="text-align: center;">⊞</td> <td style="text-align: center;">1</td> <td style="text-align: center;">⌚</td> <td style="text-align: center;">50 psi</td> </tr> <tr> <td style="text-align: center;">1:1</td> <td style="text-align: center;">1.00:1</td> <td style="text-align: center;">⚙️</td> <td style="text-align: center;">500 cc/min</td> </tr> <tr> <td style="text-align: center;">⌚</td> <td style="text-align: center;">44 min</td> <td style="text-align: center;">⊞</td> <td style="text-align: center;">222 cc</td> </tr> <tr> <td style="text-align: center;">ti22008a</td> <td style="text-align: center;">W</td> <td style="text-align: center;">X</td> <td></td> </tr> </table>		V U		Y Z	⊞	1	⌚	50 psi	1:1	1.00:1	⚙️	500 cc/min	⌚	44 min	⊞	222 cc	ti22008a	W	X	
	V U			Y Z																		
⊞	1		⌚	50 psi																		
1:1	1.00:1		⚙️	500 cc/min																		
⌚	44 min		⊞	222 cc																		
ti22008a	W		X																			
V	Current Ratio (1:1) (Not shown in 1K Mode.)*																					
W	Potlife Time Remaining (⌚)*																					
X	Total Volume for the Current Job (⊞)*																					
Y	Current Flow Rate (⚙️)*																					
Z	Current Pressure (⌚)*																					

\* Applies specifically to the active Mix Unit on the display. To toggle between Mix Units, use the Up/Down arrows on the Navigation keypad (  ).





## Spray Screen

**NOTE:** In normal operating mode, controlled by a PLC, the Spray Screen is display only. No changes can be made. This section provides information about the Spray Screen if Manual Override is enabled on [System Screen 1, page 68](#). The screens show a system in Manual Override mode.

The Spray screen includes the following information for the selected Mix Unit:

- Active Recipe (can be changed on this screen)
- Target Ratio (not shown in 1K Mode)
- Actual Ratio (not shown in 1K Mode)
- Target Pressure (if Pressure Mode is selected on System Screen 4) or Target Flow (if Flow Mode is selected). Target pressure or flow can be changed on this screen).
- Actual Pressure
- Actual Flow
- Potlife Remaining
- Gun Animation

In addition, the Spray screen includes four soft keys:

- |   |                                     |
|---|-------------------------------------|
|   | Press to put the system in Standby. |
|  | Press to spray mixed material.      |
|  | Press to purge the gun.             |
|  | Press to switch between Mix Units   |

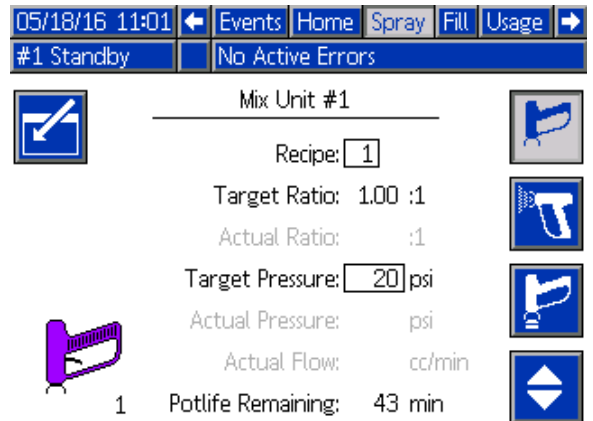

Figure 20 Spray Screen, in Standby Mode

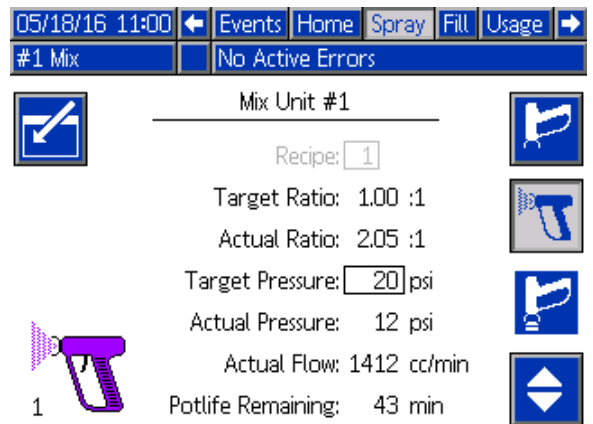

Figure 21 Spray Screen, in Mix Mode



Figure 22 Spray Screen, in Idle Mode



## Fill Screen





**NOTE:** This screen is visible only if Manual Override is enabled on [System Screen 1, page 68](#).

The Fill screen displays the following information for the pump assigned to the current color:

- Material. Select Color (A), Catalyst (B), or Solvent. The pump animation at the top of the screen will show the selected material.
- Flush Line (only for systems with color change). Select this box if you want to flush the specified material line. The system uses flush sequence 1.

**NOTE:** Use the toggle softkey to switch between Mix Units.

To prime the pumps and fill the lines, first read [Prime and Fill the System, page 20](#).

1. Press the Edit softkey  to open the screen for editing.
2. Select Color (A).
3. If the selected material is not already loaded, press the Prime softkey . The system will prime Color (A) into the selected pump through the selected color valve and out the outlet dump valve.
4. Press the Fill softkey . The system will attempt to fill the Color (A) lines until the user presses Stop . Trigger the gun into a waste container.
5. Repeat for Catalyst (B).

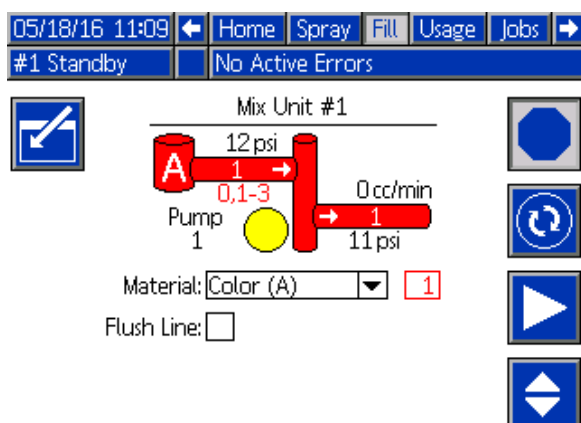

Figure 23 Fill Screen, Color (A) Selected

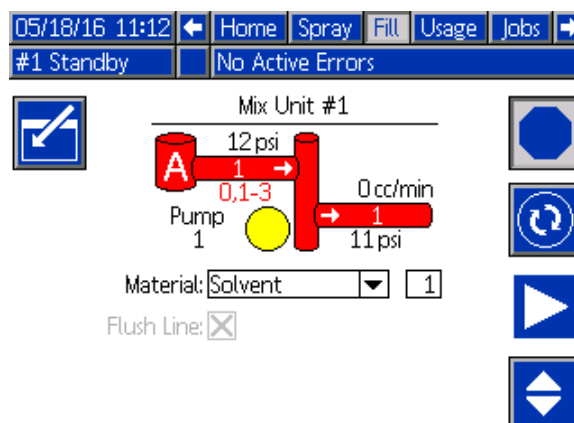

Figure 24 Fill Screen, Solvent Selected

### Pre-Fill Pump

The pump pre-fill option is available for pumps that have color change, but only a single material (color or catalyst). The pre-fill option may be used for pumps that remain filled with material when the system was powered down.

Press the Pre-Fill softkey  to “prime” the pump without flushing or expelling any material unnecessarily.

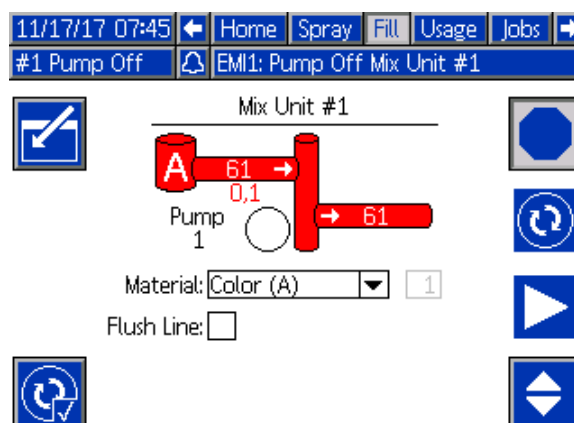





Figure 25 Fill Screen, Pre-Fill Option

## Usage Screen

The first Usage screen displays the current job usage of component A, B, A+B, and solvent (S). The second Usage screen displays grand total usage of component A, B, A+B, and solvent (S). Edits may be made only if Manual Override is enabled on [System Screen 1, page 68](#). The third Usage screen displays the total volume pumped for all available materials.

**NOTE:** In 1K Mode, the B and A+B components are not shown.

1. Press the Edit softkey  to open the screen for editing.
2. To enter or change the User ID (⌘), select the field to open the User ID Keyboard screen, and enter the desired name (10 characters maximum).
3. To log the current job for the appropriate Mix Unit, press the corresponding Job Complete softkey,  or . This will clear the current usage fields and increment to the next job number. The Grand Totals cannot be cleared. See the [Jobs Screen, page 67](#), to review past jobs.
4. Press the Edit softkey  to close the screen.

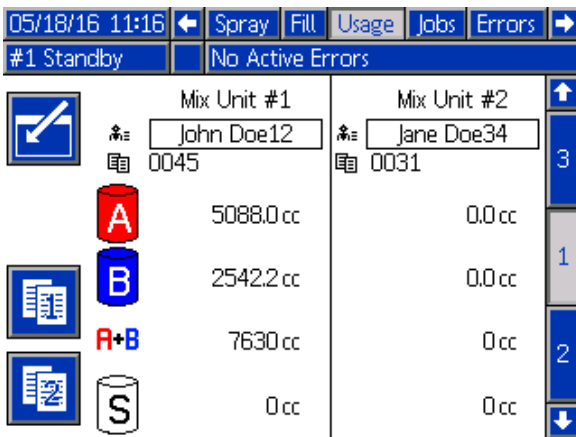

Figure 26 Usage Screen

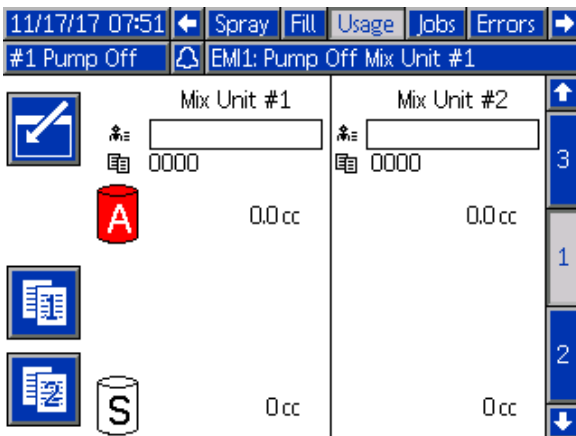

Figure 27 Usage Screen, 1K Mode

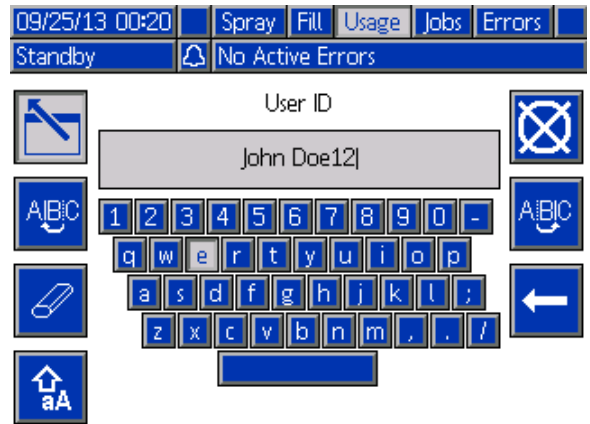

Figure 28 User ID Keyboard Screen

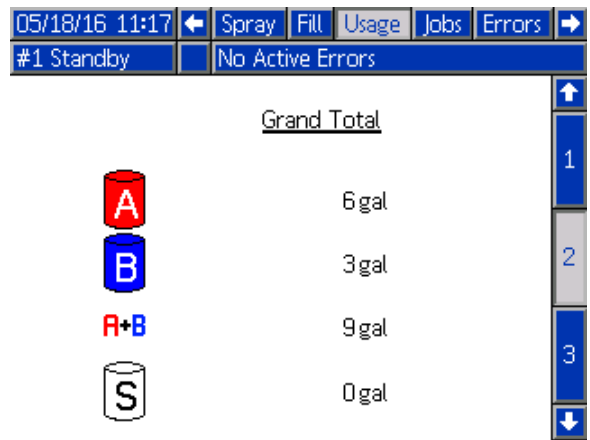

Figure 29 Usage Grand Total

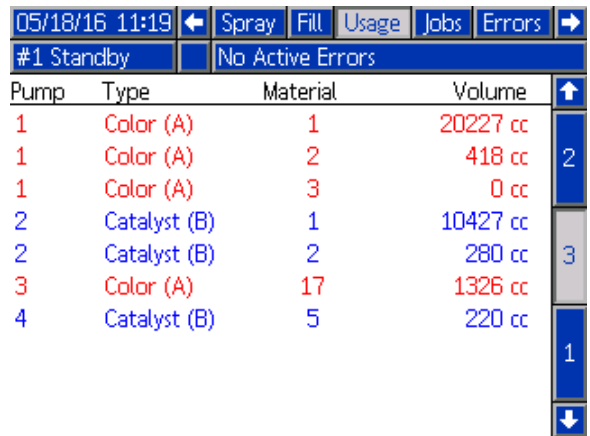

Figure 30 Usage Log

## Jobs Screen

The Jobs screen displays the 200 most recent job numbers, recipes, Mix Unit, and A+B volumes in a log, with date, time, and User ID.

05/18/16 11:38								←	Fill	Usage	Jobs	Errors	Events	→	
#1 Mix								No Active Errors							
📅	🕒	👤	📄	🔍	🔍	🔍	🔍	⬆️							⬆️
05/18/16	11:38	John Doe12	0052	1	1	238	cc	5							
05/18/16	11:38	Jane Doe34	0053	2	2	102	cc	6							
05/18/16	11:37	Jane Doe34	0051	2	2	288	cc	1							
05/18/16	11:37	John Doe12	0049	1	1	318	cc	2							
05/18/16	11:37	Jane Doe34	0050	2	2	68	cc	3							
05/18/16	11:37	Jane Doe34	0047	2	2	369	cc	4							
05/18/16	11:37	John Doe12	0048	1	1	103	cc	↓							
05/18/16	11:37	John Doe12	0045	1	1	7722	cc								
05/18/16	11:33	Jane Doe34	0046	2	2	0	cc								
05/18/16	11:33	Jane Doe34	0031	61	2	0	cc								

Figure 31 Jobs Screen

## Errors Screen

The Errors screen displays the 200 most recent Error Codes in a log, with date, time, and description.

Additional information is available for system errors to assist with troubleshooting. To access this information for a system error that has occurred, first

press  to enter edit mode; the first error will be highlighted. Using the Up and Down arrow keys,

navigate to the desired error code, press  again (see [System Errors, page 97](#), for more information on the troubleshooting information screens).

08/10/13 23:17								←	Jobs	Errors	Events	Home	→		
Idle								No Active Errors							
📅	🕒	👤	📄	🔍	🔍	🔍	🔍	⬆️							⬆️
08/10/13	22:44	DK04-A	Position Pump 4					18							
08/10/13	22:44	DK03-A	Position Pump 3					19							
08/10/13	22:44	DK02-A	Position Pump 2					20							
08/10/13	22:44	DK01-A	Position Pump 1					1							
08/10/13	22:44	CA0X-A	Comm. Error ADM					2							
08/10/13	22:44	P6D4-A	Press. Sens. Removed Outlet 4					3							
08/10/13	22:44	P6D3-A	Press. Sens. Removed Outlet 3					4							
08/10/13	22:44	P6D2-A	Press. Sens. Removed Outlet 2					↓							
08/10/13	22:44	P6D1-A	Press. Sens. Removed Outlet 1												
08/10/13	22:44	DK04-A	Position Pump 4												

Figure 32 Errors Screen

11/17/17 08:11								←	Jobs	Errors	Events	Home	→		
#1 Standby								No Active Errors							
📅	🕒	👤	📄	🔍	🔍	🔍	🔍	⬆️							⬆️
11/17/17	08:08	F8D1-A	Flow Not Detected Mix Unit #					1							
11/17/17	08:08	F8D1-A	Flow Not Detected Mix Unit #					2							
11/17/17	08:08	F8D1-A	Flow Not Detected Mix Unit #												
11/17/17	08:04	SPD1-A	Purge Incomplete Gun 1												
11/17/17	08:03	SAD1-A	Atomizing Solvent Mix Unit #1												
11/17/17	08:03	F7S1-A	Flow Detected Solvent Gun 1												
11/17/17	08:03	F7P1-A	Flow Detected Air Gun 1												
11/17/17	08:03	F7S2-A	Flow Detected Solvent Gun 2												
11/17/17	07:43	P6D4-A	Press. Sens. Removed Outlet 4												
11/17/17	07:43	P6D3-A	Press. Sens. Removed Outlet 3												

Figure 33 Errors Screen, Edit Mode

## Events Screen

The Events screen displays the 200 most recent Event Codes in a log, with date, time, and description.

08/10/13 23:17								←	Errors	Events	Home	Spray	→		
Idle								No Active Errors							
📅	🕒	👤	📄	🔍	🔍	🔍	🔍	⬆️							⬆️
08/10/13	22:52	EC00-R	Setup Value(s) Changed					18							
08/10/13	22:51	EVUX-V	USB Disabled					19							
08/10/13	22:49	EBUX-R	USB Drive Removed					20							
08/10/13	22:48	EVUX-V	USB Disabled					1							
08/10/13	22:46	EBUX-R	USB Drive Removed					2							
08/10/13	22:46	EC00-R	Setup Value(s) Changed					3							
08/10/13	22:45	EQU0-V	USB Idle					4							
08/10/13	22:45	EQU1-R	Sys. Settings Downloaded												
08/10/13	22:45	EQU3-R	Custom Lang. Downloaded												
08/10/13	22:45	EQU5-R	Logs Downloaded												

Figure 34 Events Screen

# Setup Mode Screens

Press  on any Run screen to enter the Setup screens.

Most parameters on the Setup screens may be configured individually for each Mix Unit, while some are global. Those that may be set individually appear in two columns.

**NOTE:** Selection fields and buttons that are grayed-out on the screens are not currently active.

If the system has a password lock, the Password screen displays. See [Password Screen, page 68](#).

## Password Screen

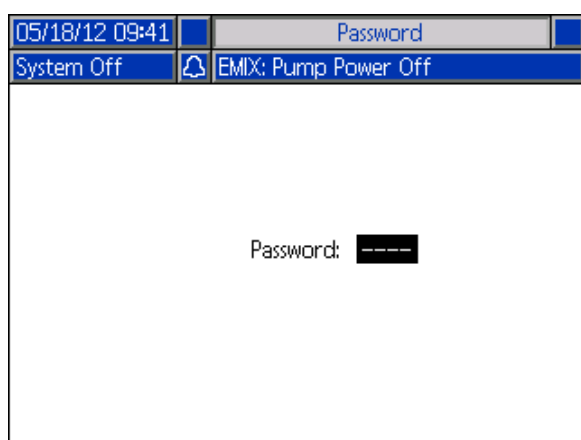



Figure 35 Password Screen

Enter the 4 digit password, then press . System screen 1 will open, allowing access to the other Setup screens.

Entering an incorrect password clears the field. Reenter the correct password.

To assign a password, see [Advanced Screen 1, page 90](#).

## System Screen 1

System screen 1 includes the following fields which define your system.

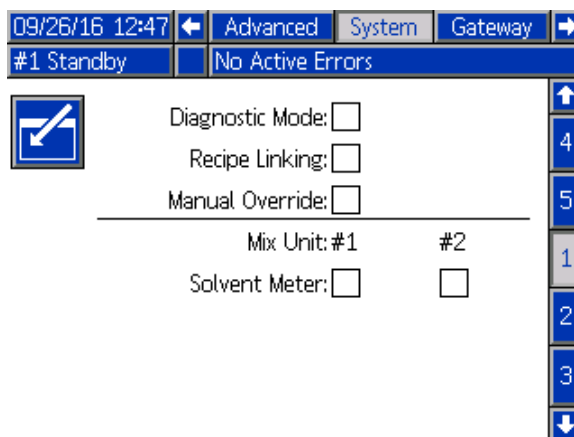

Figure 36 System Screen 1, During Standby

### Diagnostic Mode

Select this box to display flow rate and pressure for each pump on the [Home Screen, page 61](#).

### Recipe Linking

Select this box to enable recipe linking on the [Recipe Screen, page 74](#).

### Manual Override

Check this box to give users system control at the ADM. Leave the box unchecked if all system settings are controlled through a PC, PLC, or other networked device.

### Solvent Meter

Select this box if your system uses a solvent meter. The Solvent K-Factor field will then become active.

## System Screen 2

System screen 2 sets the following system operating parameters.

	Mix Unit: #1	#2
Color Pumps:	1	1
Catalyst Pumps:	1	1
Non-Mix Pressure:	20 psi	20 psi
Mix Fill Set Point:	0 psi	0 psi
Mix Idle Timeout:	120 sec	120 sec
Mix No Flow Timeout:	5 sec	5 sec
Disable Mix Unit:	<input type="checkbox"/>	<input type="checkbox"/>

Figure 37 System Screen 2, in Standby Mode

### Color Pumps

Enter the number of color pumps in your system.

### Catalyst Pumps

Enter the number of catalyst pumps in your system.

**NOTE:** Changing the number of catalyst pumps to "0" will put the mix unit into 1K Mode.

### Non-Mix Pressure (Fill Pressure - 1K Mode)

Enter a lower pressure for use when not mixing and spraying (for example during fill or flushing).

**NOTE:** Low pressure systems may be set 100 psi (0.7 MPa, 7 bar) lower than target pressure; high pressure systems may be set 300 psi (2.1 MPa, 21 bar) lower than target pressure.

### Mix Fill Set Point (Fill Set Point - 1K Mode)

Set a higher flow rate or pressure for use while mix filling to decrease the time needed to fill the hose and

spray device. Once the spray device is filled, the system will use the target set point as set by the PLC.

The default value is '0'. When set to '0', the system ignores the Mix Fill Set Point and instead uses the target set point as set by the PLC.

The value will be a flow rate if Fluid Control is set to 'Flow', or a pressure if Fluid control is set to 'Pressure'.

### Mix Idle Timeout (Idle Timeout - 1K Mode)

The Gun Trigger Input signals that the device is triggered. If you are not using a gun trigger signal, the system does not know if the spray device is spraying. If a pump failed you could spray pure resin or catalyst without knowing. This should be caught by the Mix No Flow Timeout; the default is 5 seconds. The Mix Idle Timeout will trigger Idle mode, which will run a pump stall test to check for leaks, then put the pumps in Standby (holding their current position) after the designated period of time. Enter the desired Mix Idle Timeout in this field.

See [Digital Inputs, page 24](#).

### Mix No Flow Timeout (No Flow Timeout - 1K Mode)

The Gun Trigger Input signals that the gun is triggered. If the Gun Trigger Input indicates that the gun is triggered, but there is no fluid flow through a pump, you could spray pure resin or catalyst without knowing. The Mix No Flow Timeout will cause the system to shutdown after the designated period of time. The default is 5 seconds. Enter the desired shutdown time in this field.

See [Digital Inputs, page 24](#).

### Disable Mix Unit

Select this box if you wish to prevent a mix unit from being powered up and to suppress all related alarms.

## System Screen 3

System screen 3 sets the following system operating parameters.

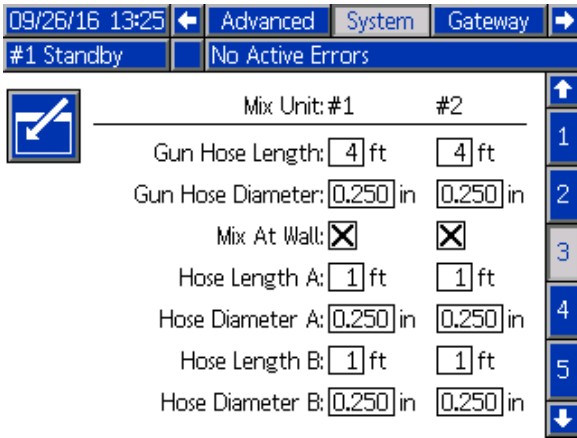

Figure 38 System Screen 3

### Gun Hose Length

Enter the length of the hose from the remote mix manifold to the spray device.

### Gun Hose Diameter

Enter the diameter of the hose from the remote mix manifold to the spray device. The minimum diameter is 1/8 in. (3 mm).

### Mix At Wall

Deselect this box only if your system is not using a remote mix manifold.

### Hose Length and Diameter

Enter the length and diameter of the hose from the remote color stack to the remote mix manifold, for both A and B hoses.

### Mix at Belt Circ.

This option is for systems that have fluid circulation and use mix-at-belt manifolds. This should not be used with Automatic systems.

## System Screen 4

System screen 4 sets the following system operating parameters.

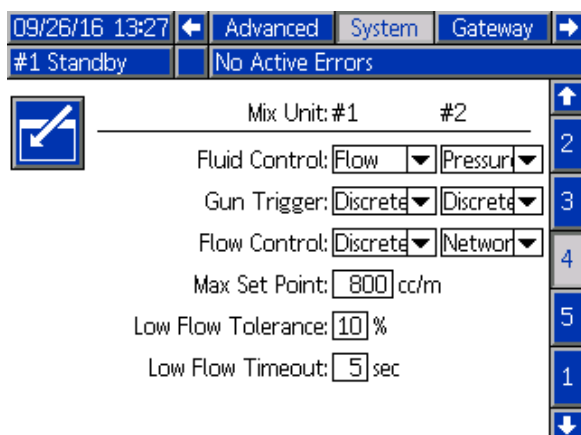

Figure 39 System Screen 4

### Fluid Control

Select the desired operating mode (pressure or flow), using the pull-down menu.

- In **Pressure Mode**, the motor will adjust the pump speed to maintain the fluid pressure set by an external control device.
- In **Flow Mode**, the motor will maintain a constant speed to maintain the target flow rate set by an external control device.

### Gun Trigger Signal

Select the format of the signal indicating whether the spray device is triggered.

- Discrete — the signal is sent via a direct, hard-wired connection
- Network — the signal is sent via a PC, PLC, or other networked device.

### Flow Control (Setpoint Signal)

Select the format of the signal that indicates system flow rate or pressure.

- Discrete — the signal is sent via a direct, hard-wired connection. This selection will make the Max Set Point field active.
- Network — the signal is sent via a PC, PLC, or other networked device.
- Recipe — flow rate or pressure is set according to user-entered value on each recipe screen.

### Max Set Point

Set the scaling factor for the 4–20 mA discrete Flow Control Signal (see [Analog Inputs](#), page 24).

### Low Flow Tolerance

This field is active if Fluid Control is set to 'Flow'. The system will detect if the flow rate falls below a designated percentage of the target flow rate. Set that percentage in this field. For example, you might want the system to time out if it detects a flow rate that is 10 percent of the target, rather than waiting until a no flow timeout occurs.

### Low Flow Timeout

The low flow timeout causes the system to shut down after the designated period of time if the flow rate continues to be at or below the low flow tolerance set in the previous section. The default is 5 seconds. Enter the desired shutdown time in this field.

### Solvent K-Factor

Enter the solvent meter K-Factor.

## System Screen 5

System screen 5 sets the following operating parameters.

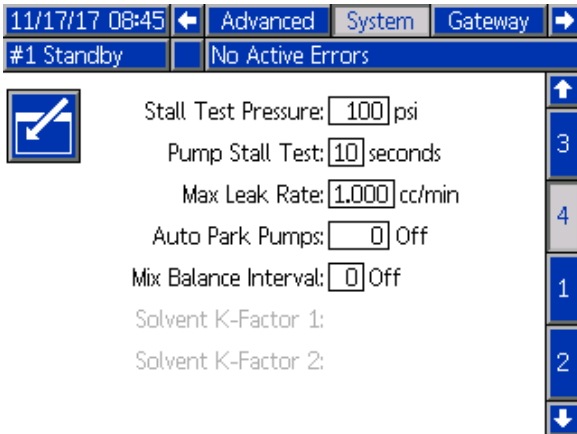

Figure 40 System Screen 5

### Stall Test Pressure

Set the minimum stall test pressure. The setting should be approximately 50 psi (0.35 MPa, 3.5 bar) higher than the highest inlet pressure.

**NOTE:** If the material supply pressure at the pump inlet is greater than 90% of the Stall Test Pressure, the system will generate an alarm and will not complete the stall test. See [Calibrate Screen 1, page 86](#).

### Pump Stall Test

Set the duration for the pump stall test. See [Calibrate Screen 1, page 86](#).

### Maximum Leak Rate

Enter the maximum allowable leak rate for a pump stall test.

## Auto Park Pumps

Parking the pumps will help prevent material from hardening on the pump rods. The Auto Park Pumps timer will automatically park all pumps and turn off pump power. The default value of 0 minutes turns off this feature.

**NOTE:** The timer only runs while the system is in Standby and all guns are purged to prevent volumes from going off ratio.

## Mix Balance Interval (Not used in 1K Mode)

When transitioning from Standby mode to Mix Mode, fluid viscosities and high ratios may affect how quickly fluid dynamics balance, which may result in nuisance Exceed Max Flow or Differential Pressure mixing alarms.

The Mix Balance Interval set point may be used to enable a brief period at the start of a mix cycle for fluids to balance before generating any mixing alarms.

**NOTE:** The Mix Balance Interval timer only runs while the gun is triggered. Setting this time to zero turns the timer off.

## Solvent K-Factor

Enter the solvent meter K-Factor.



## Gateway Screen

The Gateway screen sets the following system operating parameters for the CGM protocol installed.

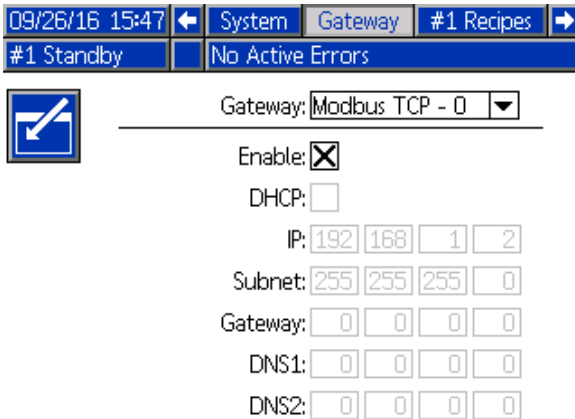

09/26/16 15:47 ← System Gateway #1 Recipes →

#1 Standby No Active Errors

Gateway: Modbus TCP - 0 ▼

Enable:

DHCP:

IP: 192 168 1 2

Subnet: 255 255 255 0

Gateway: 0 0 0 0

DNS1: 0 0 0 0

DNS2: 0 0 0 0

Figure 41 Gateway Screen

### Gateway ID

Select the desired Gateway ID from the dropdown menu.

### Enable

Uncheck Enable while setting the IP Address, Subnet mask, Gateway, DNS1 or DNS2. When the settings are loaded, check the Enable box to write the new settings to the selected Gateway.

Check this box to enable the selected Gateway so that the PLC can communicate with it.

### DHCP

Select this box if your system has a Dynamic Host Configuration Protocol (DHCP). This protocol assigns unique IP addresses to devices, then releases and renews these addresses as devices leave and rejoin the network. If selected, the IP Address, Subnet, and Gateway fields will not be editable and will display the addresses supplied by the DHCP.

### TCP/IP

Use the remaining fields to set the IP address, subnet mask, Gateway, DNS1, and DNS2.

## Recipe Screen

Each Mix Unit has its own chapter of Recipe screens (0–30): **#1 Recipes** for Mix Unit #1 and **#2 Recipes** for Mix Unit #2. These recipes can be set up entirely unique, or for systems that will be mixing two equivalent recipes at the same time, recipes can be linked between two Mix Units.

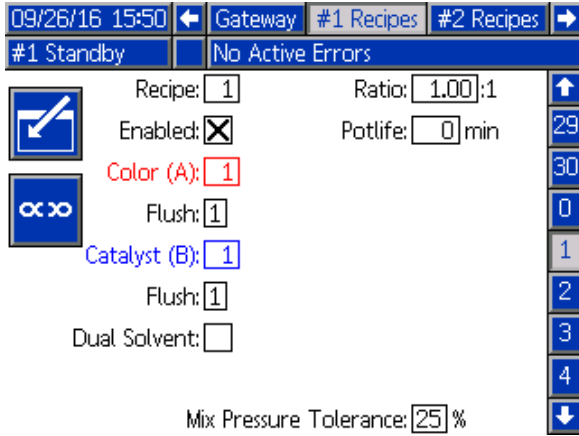

Figure 42 Valid Recipe Screen

### Linked Recipes

Pressing the Link softkey on a Recipe screen will copy data from the equivalent recipe number of the other Mix Unit to the screen currently displayed. The softkey will then change states to indicate the two recipes are linked. Once linked, changing a recipe parameter will affect both Mix Unit recipes concurrently. Recipes may be un-linked by simply pressing the Link softkey again.

Recipe linking must be enabled on [System Screen 1, page 68](#). If recipe linking is not enabled, the Link softkey will not be shown on the Recipe screen.

**NOTE:** Material numbers are still unique, so those numbers will appear different, but are equivalent relative to each Mix Unit (i.e., Color 1 = Color 17, Catalyst 1 = Catalyst 5).

**NOTE:** Recipes cannot be linked unless both or neither Mix Unit is configured for mix-at-wall.

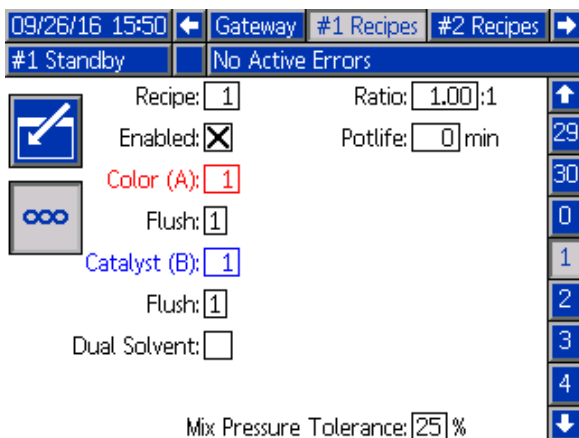

Figure 43 Linked #1 Recipes Screen

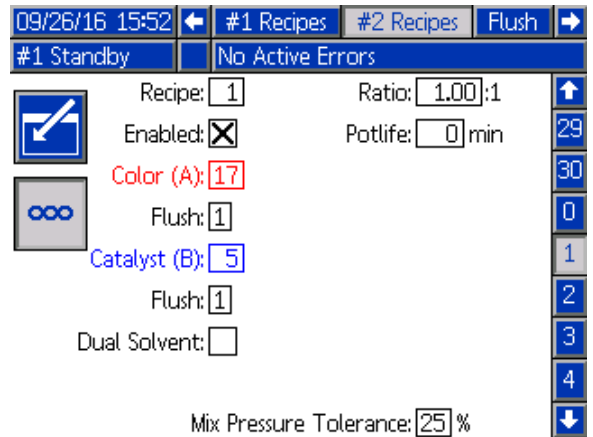

Figure 44 Linked #2 Recipes Screen

### Recipe

Enter the desired recipe number (1-30).

#### Recipe 0

Use Recipe 0 to flush the system.

- **If a recipe (1–30) is loaded:** Select Recipe 0 to flush the previously active pumps and purge the gun.
- **If Recipe 0 or 61 is loaded:** Select Recipe 0 to flush all pumps and purge the gun.

#### Enabled

Selecting “Enabled” makes the selected recipe accessible from the Spray screen on the ADM or to the PLC.

**Note:** Recipe 0 is always enabled.

#### Color (A) Valve

Enter the desired color valve number (1-32).

**NOTE:** If you enter a number which is not valid in your system configuration, the field will be highlighted and the recipe becomes invalid. For example, if your configuration has 8 color valves and you enter 14, the field will appear as shown below.

#### Flush Sequence

Enter the desired flush sequence (1-5) for the color (A) valve and the catalyst (B) valve. The gun purge time for each material depends on the flush sequence assigned to each. See [Flush Screen, page 77](#). If materials A and B require different purge times, assign separate flush sequences. Set the necessary gun purge time for each. For hard to flush colors, select a longer sequence. 1 is the default, and should be designated for the longest, most thorough flush duration.

### Catalyst (B) Valve (Disabled in 1K Mode)

Enter the desired catalyst valve number (1-8).

**NOTE:** If you enter a number which is not valid in your system configuration, the field will be highlighted and the recipe is invalid. For example, if your configuration has 1 catalyst valve and you enter 4, the field will be highlighted and the recipe is invalid.

09/26/16 15:54 Gateway #1 Recipes #2 Recipes

#1 Standby No Active Errors

Recipe: 1 Ratio: 1.00:1

Enabled:  Potlife: 0 min

Color (A): 14

Flush: 1

Catalyst (B): 1

Flush: 1

Dual Solvent:

Mix Pressure Tolerance: 25%

Figure 45 Invalid Recipe Screen

### Mix Ratio (Disabled in 1K Mode)

Enter the desired mix ratio (0 to 50.0):1.

### Potlife Time

Enter the potlife time (0 to 999 minutes). Entering 0 disables this function.

### Target Pressure/Flow

Enter the desired target spray pressure or flow rate, depending on whether the Mix Unit is configured for Pressure Control or Flow Control (see Fluid Control on System Screen 4). This is the pressure or flow rate the pumps will maintain while mixing. This field is only available when the Flow Control is set to 'Recipe' (see Flow Control on System Screen 4).

### Mix Pressure Tolerance (Disabled in 1K Mode)

The pressure of one component must be within a percentage ( $\pm$ ) of the pressure of the other component during spray or mix. Set the desired Mix Pressure Tolerance in this field. The default is 25%.

## Differential Pressure and the Mix Pressure Tolerance Set Point

A primary means of maintaining ratio assurance for the ProMix PD2K system is through monitoring of the differential pressure between the A-pump and B-pump outlets. Ideally, these two pressures would be identical, but factors such as line sizing, viscosity, and mix ratio lead to some variation. Understanding where your system typically operates is imperative when setting up an effective differential pressure check that notifies the user of potential mix ratio inaccuracies while avoiding nuisance alarms.

It is recommended that, once the system is fully installed and ready to use, the user load a recipe and then spray the mixed material. While spraying, note the outlet pressures of both the A and B pumps (per the ADM's main screen or the PLC) and spray long enough to ensure the pressures have stabilized to a nominal value. The difference between the outlet pressures of the A and B pumps is an established baseline for the Mix Pressure Tolerance set point.

The Mix Pressure Tolerance set point allows the B-side pump outlet pressure to vary a specified percentage away from the A-side pump outlet (spray) pressure. For example: In the following figure, if the spray pressure (A-side pump outlet pressure) is 100 psi, and the Mix Pressure Tolerance is set to 25%, the B-side outlet pressure is allowed to float between

75 and 125 psi (100 psi  $\pm$  25%) without generating an alarm.

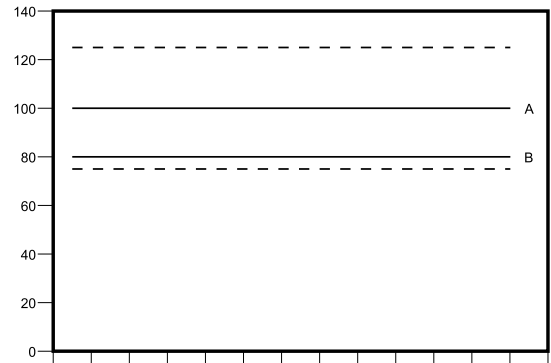

Figure 46 The acceptable B-side pump outlet pressure range for a system with a target spray pressure (A) of 100 psi and a Mix Pressure Tolerance of 25%.

It is recommended that you keep the Mix Pressure Tolerance set point as low as possible to alert the user of anything affecting the mix ratio accuracy. However, if your system is generating several differential pressure alarms, or will be mixing a wide variety of materials at different mix ratios, you may need to increase the Mix Pressure Tolerance.

## Dual Solvent

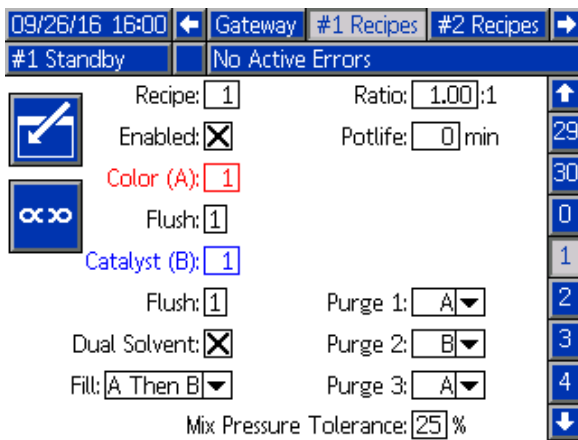

Figure 47 Dual Solvent Recipe Screen

If Mix-at-Wall is enabled on System Screen 3, Dual Solvent becomes an option on the Recipe screen.

Selecting 'Dual Solvent' enables the sequencing of flushing mixed material for a system using two types of solvent (i.e., water and solvent based) that should not be mixed together.

### Purge 1, 2, and 3

Select the sequence for purging the mixed material from the mix hose and spray device. Each stage of the sequence can be set to either 'A' or 'B'. The solvent corresponding to each material will be dispensed out the spray device for the Gun Purge Time of the Flush sequence assigned to that material for each stage. See Table 6 for a progression of the successive stages of the purge sequence.

### Fill

Select the sequence for dispensing material into the mix hose and spray device. The choices are: 'A then B', 'B then A', and 'Parallel', if no fill sequencing is necessary. The fill sequence is typically dictated by the last material used in the purge sequence. See Table 6 for a progression of the fill sequence following the last stage of the purge sequence.

Table 6 The Progression of Purge Sequence and Fill Sequence in a Dual Solvent System

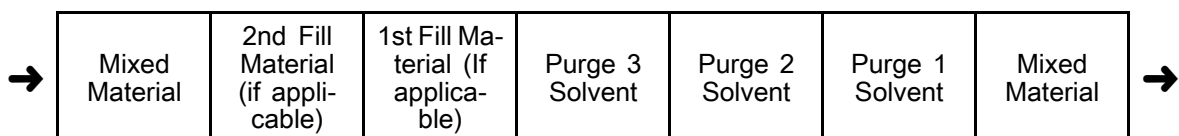

## Flush Screen

Figure 48 Flush Screen

### Flush Number

Enter the desired flush sequence (1-5). For hard to flush colors, select a longer sequence. 1 is the default, and should be designated for the longest, most thorough flush duration.

### Air/Solvent Chop

This option is available if Mix At Wall is enabled on [System Screen 3, page 70](#). Enable an air and solvent chop for flushing the gun rather than just a solvent purge. See [Air/Solvent Chop, page 78](#).

Air and solvent chop may also be enabled for flushing out a pump. See [Custom Valve Mapping, page 80](#), for more information.

**NOTE:** Air/solvent chop requires additional hardware for the air purge valve. See manual 333282 for kit numbers and installation details.

### Initial Flush

Enter the initial flush volume (0 to 9999 cc).

### Wash Cycles

A Wash Cycle activates the pump with the valves closed, to use pumping motion to thoroughly clean the pump. Enter the desired number of wash cycles (0 to 99). Entering a number will make the Strokes per Cycle field active.

### Strokes per Wash Cycle

Enter the desired pump strokes per wash cycle (0 to 99). Default is 1.

### Final Flush

Enter the final flush volume (0 to 9999 cc).

### Gun Purge Time

Enter the spray device purge time (0 to 999 seconds).

## Air/Solvent Chop

Air/Solvent Chop replaces the standard Gun Purge Time parameter on the Flush screen. Instead the purge is split into three phases: First Purge, Chop, and Final Purge. The Chop Phase will always start with Air and each phase has multiple configuration parameters.

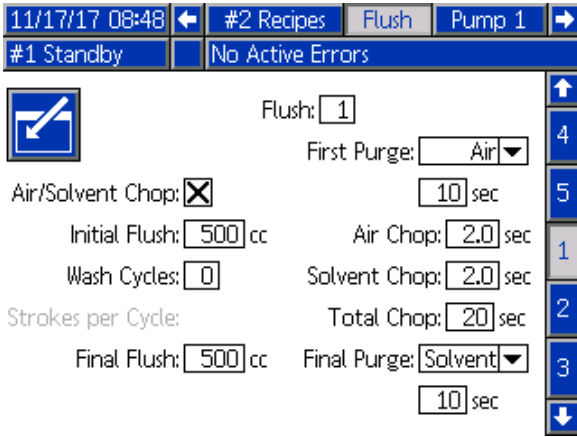

Figure 49 Flush Screen with Air/Solvent Chop

### First Purge

Select the material to be either Air or Solvent and the length of time for the first purge phase, which dispenses only the material selected.

### Air Chop

Set the air chop duty cycle for the chop phase.

### Solvent Chop

Set the solvent chop duty cycle for the chop phase.

### Total Chop

Set the length of time for the chop phase. The system will switch between air and solvent pulses according to the duty cycles set for the length of the Total Chop time.

### Final Purge

Select the material to be either Air or Solvent and the length of time for the final purge phase, which dispenses only the material selected.

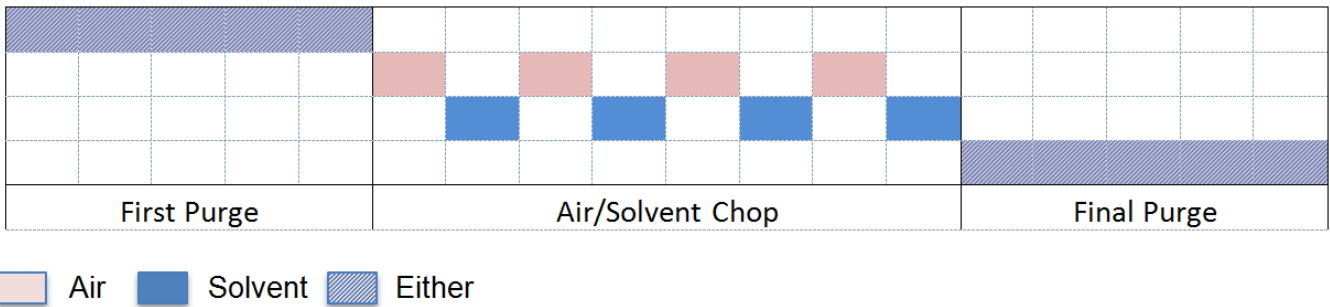

Figure 50 Air/Solvent Chop Timing Diagram

## Pump Screen 1

**NOTE:** Your system will include 4 pumps. Information for each pump is accessible under a separate tab in the menu bar at the top of the screen. Select the tab for the desired pump. Each pump has three screens. Only the screens for Pump 1 are shown here, but the same fields appear on all.

Pump screen 1 includes the following fields which define the pump.

11/17/17 08:49 ← Flush Pump 1 Pump 2 Pump 3 →

#1 Standby No Active Errors

Pump Size: 70cc

Inlet Pressure: Disabled

Color Change:

Materials: 01

Total Hose Length: 0 ft

Pump Hose Diameter: 0.000 in

Valve Mapping: Standard

Available Colors: 1 - 1

Figure 51 Pump Screen 1

### Pump Size

Select 35cc or 70cc, as appropriate.

### Inlet Pressure

Select one of the following:

- Disabled
- Monitor, to track inlet pressure

### Select Color Change

Select this box if your system uses color change.

### Materials

Enter the number of materials used in your system. Each color change module controls 8 colors.

### Hose Length

Compute the length of the hoses from the supply stack to the pump and from the pump to the outlet stack. Enter the total length.

### Hose Diameter

Enter the diameter of the supply and output hoses.

### Available Colors

The module displays the number of colors available in your system. This field is not editable.

### Valve Mapping

Select whether to use Standard, static valve mapping, or fully configurable Custom valve mapping. The color change valve mapping is the assignment of the location of the solenoids in the color change control modules. A static, pre-determined map layout makes for an easily predictable and hands-free option. However, an application and user may benefit from laying out the valve mapping on their own for consolidation of equipment, reduced hardware complexity, or simply to lay out valves according to what makes most sense.

See [Custom Valve Mapping, page 80](#) for more detailed information.

## Custom Valve Mapping

For a PD2K system that has color change, the user has an option for how the control solenoids are mapped on the control modules. Selecting Standard (default) will use the traditional, static valve mapping. The static maps are laid out logically and established for retro-fitting. If Standard is selected no additional set up for the color change valves is required at the ADM. For more information or to see the static map layouts, refer to manuals 332455 and 333282.

By selecting Custom, every color change solenoid may be assigned to any unique, valid control module location. This option offers the ultimate customization as well as the benefit of consolidation of equipment. Additionally, custom valve mapping enables some advanced color change valve features.

**NOTE:** This option applies to all pumps, so changing it for one will change it for all.

**NOTE:** When going from Standard to Custom, the PD2K will automatically pull in the static map assignments for all valves as a starting point. When going from Custom to Standard, the PD2K will clear all custom valve assignments and revert to the static mappings.

### Pump Screen - Advanced Configuration

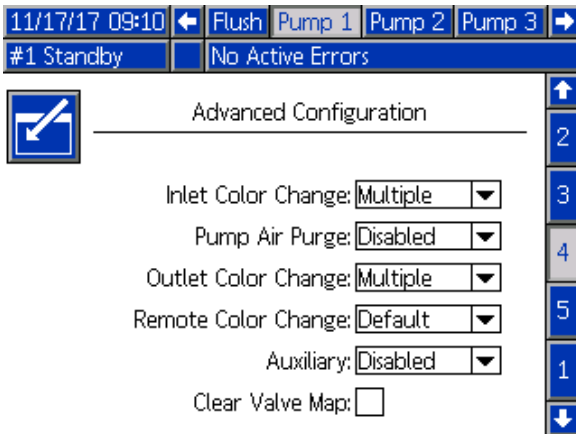

Figure 52 Pump Screen, Advanced Configuration

#### Inlet Color Change

Select Multiple if each individual material has its own valve on the inlet color stack for a particular pump.

Select Single if there is more than one material using a single valve on the inlet color stack (i.e., a piggable system). This option is only available for pumps that have more than one color change material.

**NOTE:** For systems that select Single, it is expected the user knows when a particular material is plumbed and filled to the inlet stack before performing a color change. The PD2K system does not know what material is connected up stream of the inlet valve stack.

#### Pump Air Purge

Select Enable to add an air purge valve to the pump inlet stack to allow for an air/solvent chop flush of the pump out the dump valve. Select Disable if no air purge valve will be used for the pump. This option is only available for color pumps. See Pump Air/Solvent Chop on [Pump Screen - Valve Assignment, page 82](#), for further detail.

#### Outlet Color Change

Select Multiple if each individual material has its own valve on the outlet color stack for a particular pump. Select Single if there is more than one material using a single hose connected to the outlet color stack. This option is only available for pumps that have more than one color change material.

**NOTE:** If Single is selected, the hose connected to the outlet stack will need to be purged before completing a color change.

#### Remote Color Change

Select Multiple if each individual material has its own valve on the remote color stack for a particular pump. Select Single if there is more than one material using a single hose connected to the remote color stack. Select Disable if there are no remote color change valves (only solvent and air) for the pump. The Disable option is only available if Mix-at-Wall is enabled, and Single is only available for pumps that have more than one color change material.

**NOTE:** Unless Disabled is selected, this must match the selection for Outlet Color Change unless.

**NOTE:** If Single is selected, the hose connected between the outlet stack and remote stack will need to be purged before completing a color change.



## Auxiliary

Select Enable to add an auxiliary valve downstream of the remote valve stack for the pump. The Auxiliary valve is only opened when that particular pump is dispensing (either mixing or purging). This option is only available if Mix-at-Wall is enabled.

The following figure illustrates an example application of the auxiliary valve. Pumps 1 and 3 both dispense color, but one is solvent based and one is water based. (Pump 2 dispenses a catalyst.) With the auxiliary valves in place for both pumps, only one will flow through the A-side of the remote mix manifold, and the other is completely isolated by the auxiliary valve.

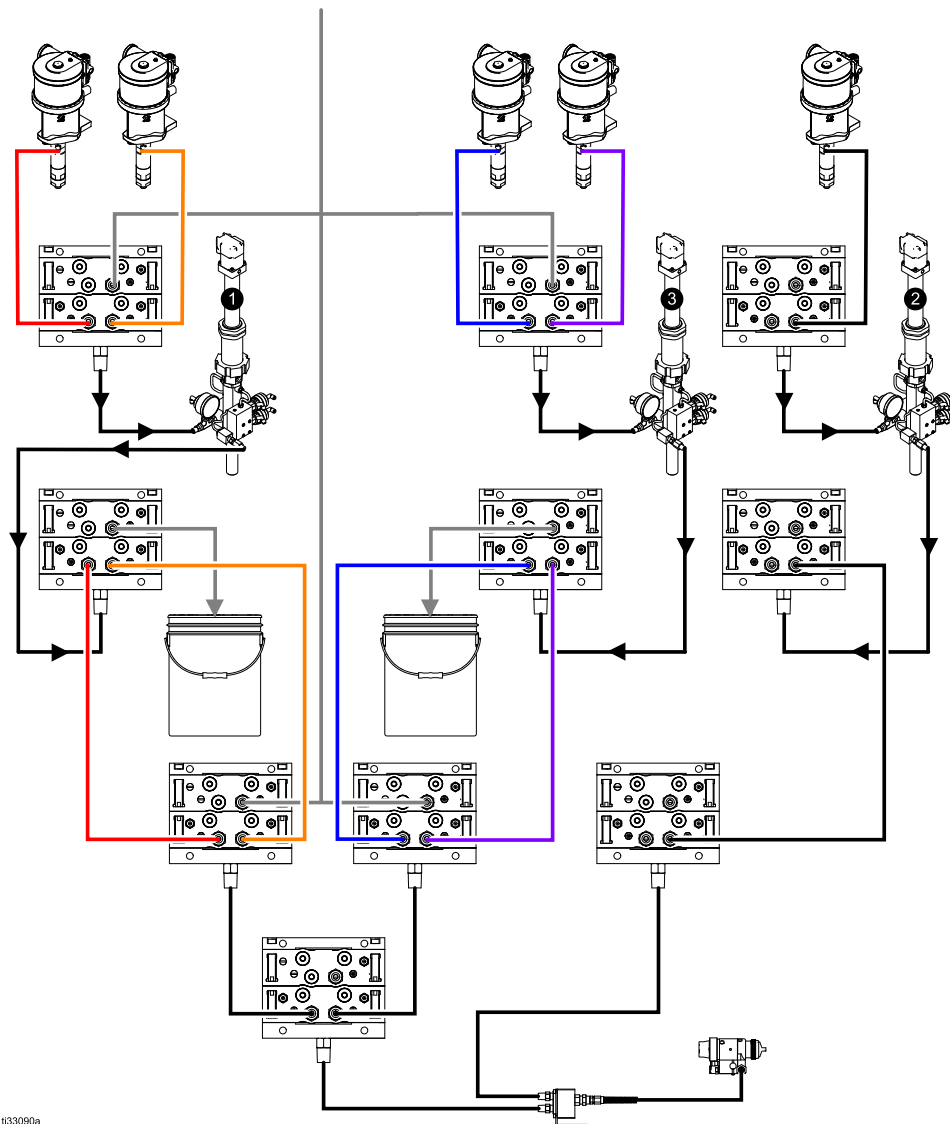

t133090a

Figure 53 Example Application of the Auxiliary Valve

## Clear Valve Map

Check this box to clear all valve assignments. The user will be prompted to confirm the choice. This will erase any valve assignments permanently, including

any that were automatically set based on the static mapping.

### Pump Screen - Valve Assignment

11/17/17 09:40		←	Flush	Pump 1	Pump 2	Pump 3	→
#1 Standby		No Active Errors					
Valve	Location						
Inlet Solvent	1 01			3			
Inlet Color 1	1 02			4			
Inlet Color 2	1 03			5			
Outlet Dump	1 10			1			
Outlet Color 1	1 11			2			
Outlet Color 2	1 12						
Remote Solvent Gun 1	7 01						
Remote Color 1	7 02						
Remote Color 2	7 03						
Remote Air Purge Gun 1	7 14						

Figure 54 Pump Screen, Valve Assignment

This screen allows the user to assign each individual color change valve solenoid in the system to a unique

location. The list of valves will automatically populate based on the settings that apply to the pump. A description of the valve includes what stack it belongs to, the material identification, and a specific gun or pump designator, if that applies.

**NOTE:** Some remote stack valves may be shared by more than one pump. They will show up on the valve list for all pumps to which they apply.

All color change valves require a valid location be assigned for the system to be able to operate properly. There are two columns that determine the solenoid location. The left column is the color change module number. This number must be between 1 and 8 and should reflect the dip switch settings on one of the color change boards (see manual 332455 for more details on dip switch settings). The second column is the solenoid location, and this number must be between 1 and 18. The following figure shows the solenoid location enumeration.

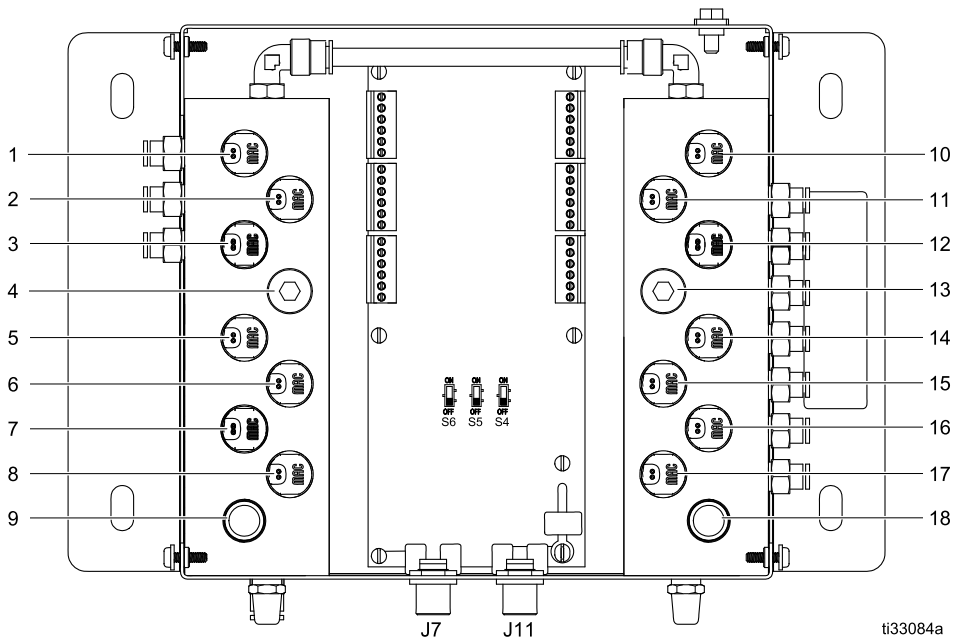

Figure 55 Solenoid Location Enumeration

If more than one valve is assigned a valid solenoid location, all instances of that location will be highlighted in red, and are considered invalid.

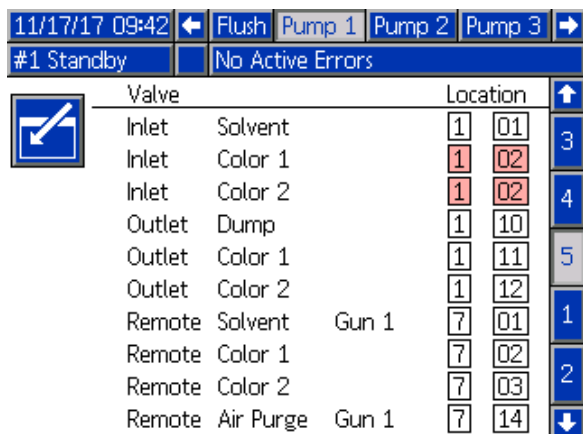

Figure 56 Pump Screen, Valve Assignment with duplicates

A value of 0 for the control module, or 00 for the solenoid, indicates no previous location assignment and both are also invalid assignments.

If a valve location is considered invalid, any operation that uses that valve will be prevented from running. This is easily identified on the Recipe screens. If any of the material's valves are considered invalid, that material will be highlighted red. If any of the valves used in the flush procedure are considered invalid, the flush sequence will be highlighted red.

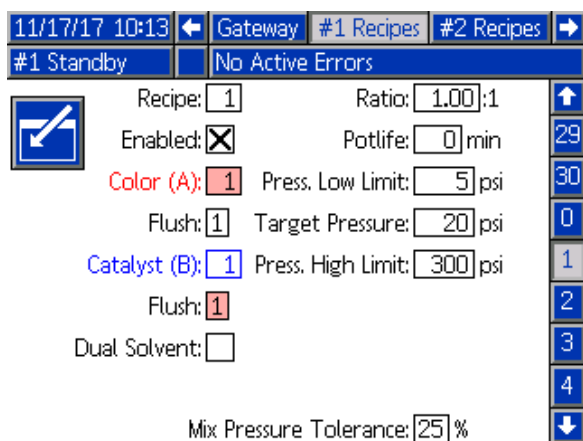

Figure 57 Recipe Screen with invalid valve location

### Pump Air/Solvent Chop

Enabling an air purge valve on the inlet stack of a color pump allows for an air/solvent chop during the pump flush process. The air/solvent chop will replace the wash cycles in a pump flush. Instead, the pump will run at a steady speed for the set number of strokes (full length travel in one direction) while alternating between air and solvent for the desired duty cycles. One pump stroke takes approximately 2 seconds during this phase.

**NOTE:** Air/solvent chop requires additional hardware for the air purge valve. See manual 333282 for kit numbers and installation details.

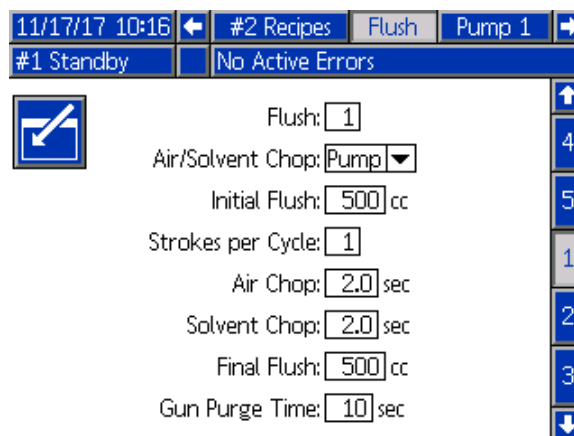

Figure 58 Flush Screen with pump air/solvent chop

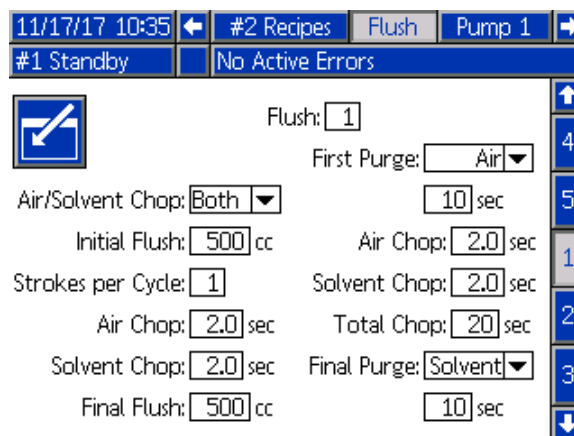

Figure 59 Flush Screen with both air/solvent chops

To enable air/solvent chop for a pump flush, check the Air/Solvent Chop box on the Flush screen. Because air/solvent chop may also be used for purging the gun, if Mix-at-Wall is enabled, the Air/Solvent Chop option becomes a pull-down selection where the user may choose None, Pump, Gun, or Both. If air/solvent chop is enabled for the gun purge, all gun purge parameters will appear on the right side, and pump flush parameters are on the left side. The following parameters apply to the pump flush. For details on air/solvent chop for the gun, see [Flush Screen, page 77](#).

### Air Chop

Set the air chop duty cycle for the chop phase of the pump flush.

### Solvent Chop

Set the solvent chop duty cycle for the chop phase of the pump flush.

## Pump Screen 2

Pump screen 2 sets the pressure transducer settings for the pump.

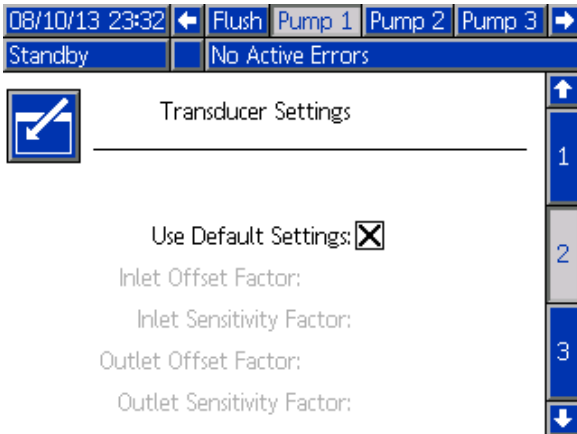

Figure 60 Pump Screen 2, Default Settings Enabled

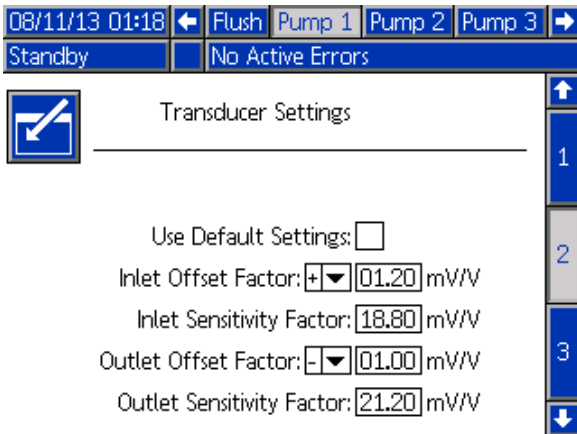

Figure 61 Pump Screen 2, Default Settings Disabled

### Default Settings Selected

When the “Use Default Settings” box is selected, default settings are used for the calibration values, and the fields are grayed out.

### Default Settings Not Selected

When the “Use Default Settings” box is not selected, the following calibration values must be entered. Invalid values will be over-ridden and the system will automatically select the default settings.

- Inlet Offset Factor: This field is only used if **Inlet Pressure** in [Pump Screen 1, page 79](#) is set to Monitor; it is grayed out if set to Disabled. The valid range is -01.20 to +01.20 mV/V.
- Inlet Sensitivity Factor: This field is only used if **Inlet Pressure** in [Pump Screen 1, page 79](#) is set to Monitor; it is grayed out if set to Disabled. The valid range is 18.80 to 21.20 mV/V.
- Outlet Offset Factor: The valid range is -01.20 to +01.20 mV/V.
- Outlet Sensitivity Factor: The valid range is 18.80 to 21.20 mV/V.

## Pump Screen 3

Pump screen 3 sets the pressure alarm limits for the pump.

When **Inlet Pressure** in [Pump Screen 1, page 79](#) is set to Disabled, the inlet limit fields are grayed out and only the outlet limit fields are active. See [Pressure Alarm and Deviation Limits, page 85](#).

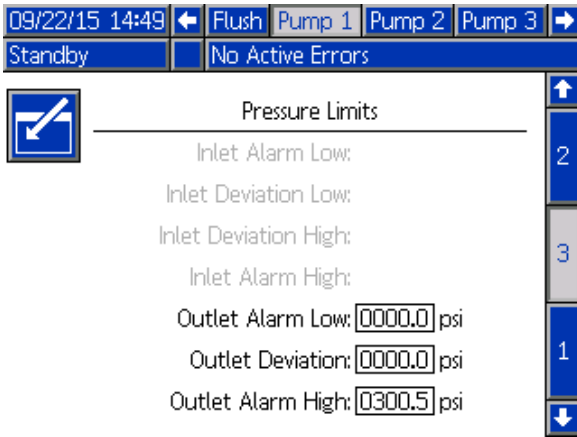

Figure 62 Pump Screen 3, Pressure Monitoring Disabled

When **Inlet Pressure** in [Pump Screen 1, page 79](#) is set to Monitor, all fields are active. See [Pressure Alarm and Deviation Limits, page 85](#).

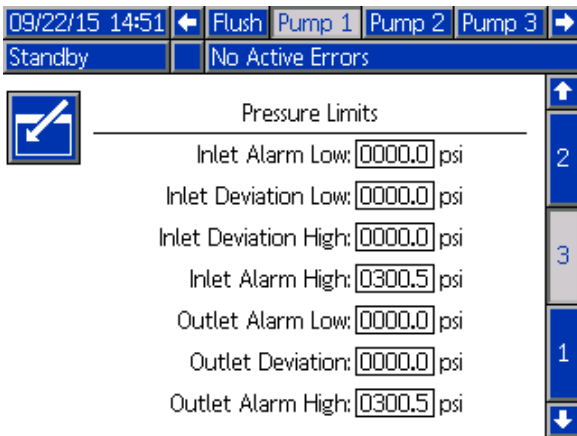

Figure 63 Pump Screen 3, Pressure Monitoring Enabled

## Pressure Alarm and Deviation Limits

Inlet fields are only active if **Inlet Pressure** in [Pump Screen 1, page 79](#) is set to Monitor; they are grayed out if set to Disabled. Outlet fields are active at all times.

- Alarm and Deviation ranges are 0-300 psi for low pressure systems, and 0-1500 psi for high pressure systems.
- Setting to 0 will disable the alarm. The Inlet Alarm High and Outlet Alarm High **cannot** be disabled.
- Alarms and Deviations will display when the inlet or outlet pressure drops below the low limit or exceeds the high limit.

**NOTE:** Outlet Alarm Low is only enabled for systems using Flow Control.

## Calibration Screens

### Calibrate Screen 1

Calibrate Screen 1 initiates a pump pressure check (stall test) for the selected pump. During the test, the Stall Test screen will appear.

The pump and lines must be primed with color or catalyst before doing the stall test. See [System Screen 2, page 69](#), to set test parameters. See [Pump Pressure Check, page 94](#) for complete test instructions.

To initiate the test, press the Pressure Check  button for the desired pump. The system will first check the inlet pressure due to the material supply pressure. If this pressure is greater than 90% of the Stall Test Pressure, the system will generate an alarm and halt the stall test. The pump will build pressure in the line to a minimum of the Stall Test Pressure. The pump will then move to the center stroke position and stall test the upstroke, followed by the downstroke.

**NOTE:** The Last Passed log can only be reset by successfully completing the test.

The screen displays the number of days since the last stall test was passed for each pump.

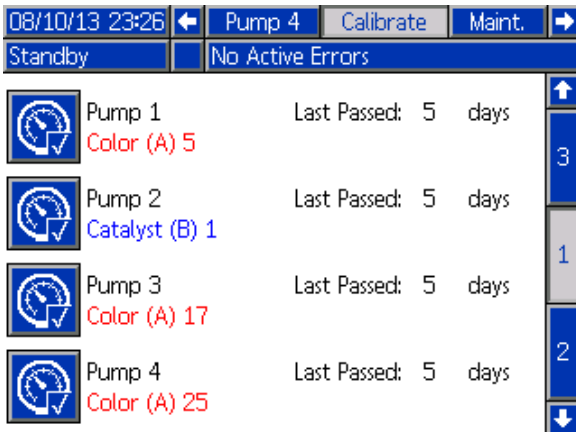

Figure 64 Calibrate Screen 1

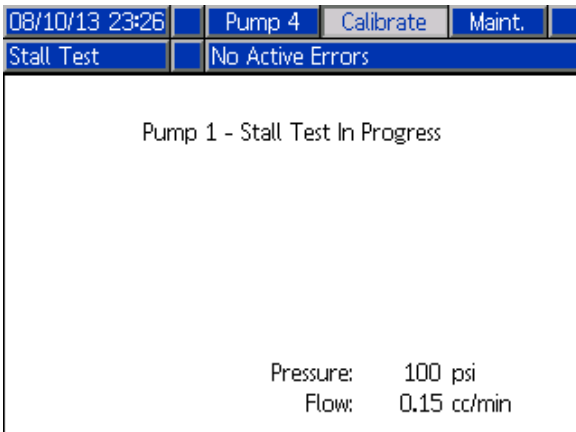



Figure 65 Stall Test Screen

### Calibrate Screen 2

Calibrate Screen 2 initiates a volume test for the selected pump. During the test, the Volume Check screen will appear.

The pump and lines must be primed with color or catalyst before doing the Volume Check. See [Pump Volume Check, page 95](#) for complete test instructions.

To initiate the test, press the Volume Check  button for the desired pump.

The screen displays the volume dispensed. Press  to end the test.

Press and hold the Reset button  for 1-2 seconds to reset the volume counter.



Figure 66 Calibrate Screen 2

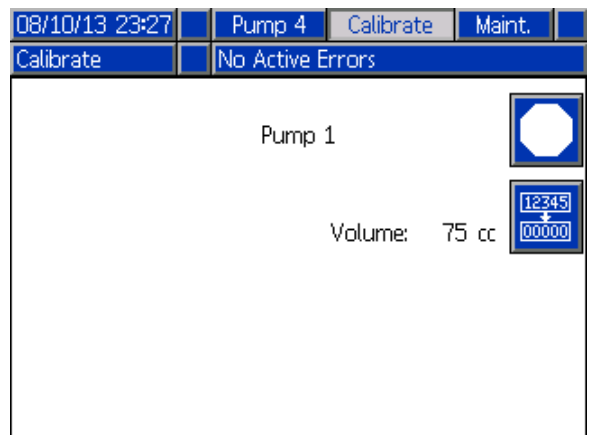



Figure 67 Volume Check Screen

### Calibrate Screen 3



Calibrate Screen 3 initiates a calibration of an accessory solvent meter. During the test, the Volume Verification screen will appear.

The meter and lines must be primed with solvent before doing the calibration. See [Solvent Meter Calibration, page 95](#) for complete instructions.

To initiate the calibration, press the Volume Check  button.

The screen displays the volume dispensed. Enter the amount of solvent dispensed in the Measured

Volume field, or press  to end the test.

After the Measured Volume is entered, the Accept Calibration window will appear. Press  to accept the calibration. Press  to cancel the calibration and retain the previous K-factor.

Press and hold the Reset button  for 1-2 seconds to reset the volume counter.

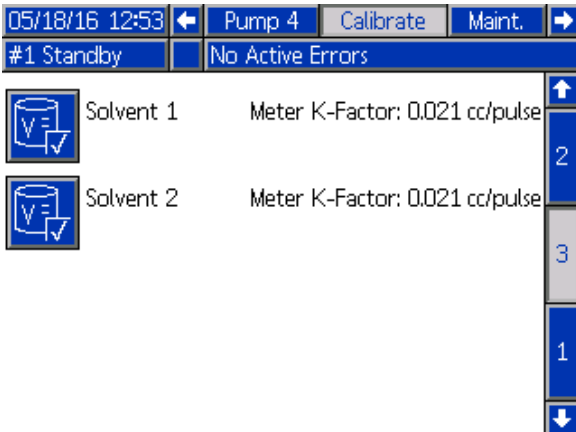

Figure 68 Calibrate Screen 3

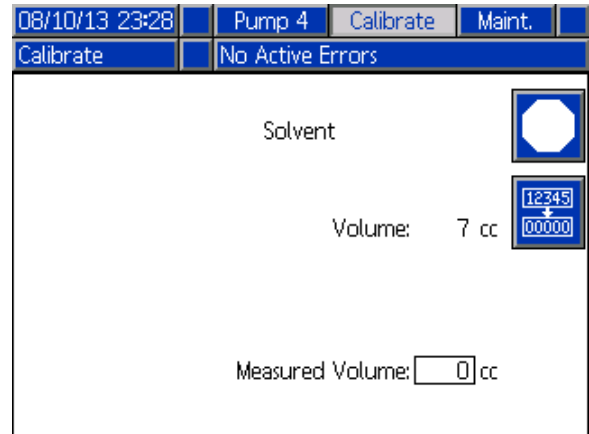

Figure 69 Enter Measured Volume of Solvent

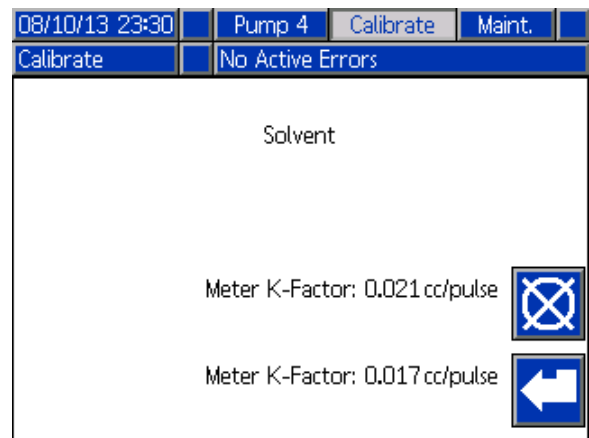

Figure 70 Accept Calibration

## Maintenance Screens

### Maintenance Screen 1

Use this screen to set maintenance intervals. Set to 0 to disable the alarm.

**NOTE:** The Pump Stall Test cannot be disabled. You must enter a value other than 0.

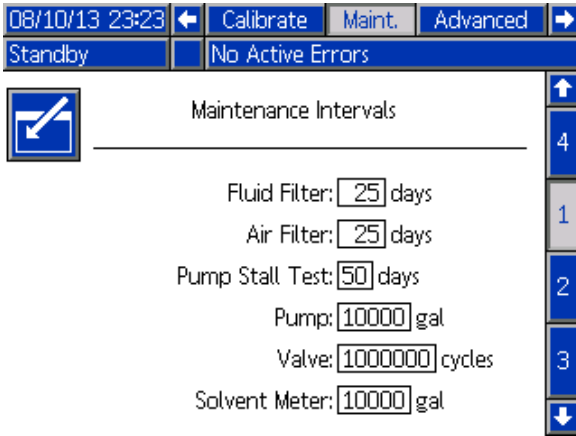



Figure 71 Maintenance Screen 1, Interval Settings

### Maintenance Screen 2

Maintenance screen 2 shows the current interval status of the solvent meter, fluid filter, and air filter.

Press and hold the Reset button  for 1-2 seconds to clear the alarm and reset the counter.

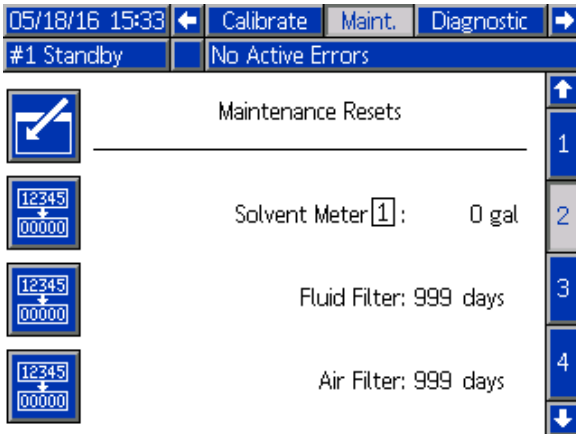



Figure 72 Maintenance Screen 2, Current Status

### Solvent Meter

If two solvent meters are used, enter the desired solvent meter number.

### Maintenance Screen 3

Maintenance screen 3 shows the current interval status of the pump maintenance tests.

Press and hold the Reset button  for 1-2 seconds to clear the alarm and reset the counter.

**NOTE:** The Pump Stall Test can only be reset by successfully completing the test.

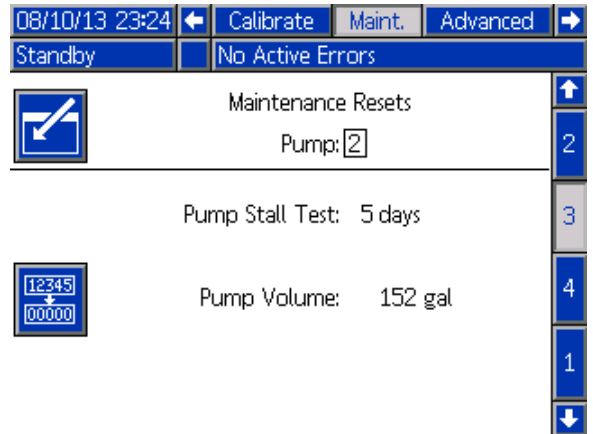

Figure 73 Maintenance Screen 3, Current Pump Status



### Maintenance Screen 4

Maintenance Screen 4 provides the ability to relieve pump outlet pressure. This feature is only functional for pumps that have color change valves (fluid pressure is relieved via the dump valve).

**NOTE:** This function is particularly useful if your paint kitchen is in a controlled environment, but the PD2K Dual Panel unit is not and is subject to warm, or even hot, conditions.

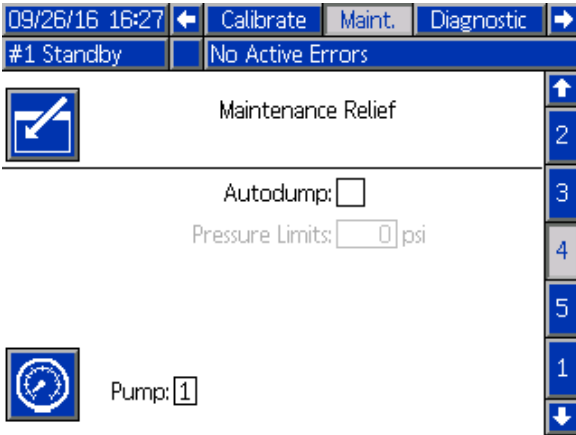

Figure 74 Maintenance Screen 4, Pump Pressure Relief

### Manual Pressure Relief

Enter the number of the pump for which you wish to relieve outlet pressure (pump must have a dump valve) and press the Pressure Relief softkey. The system will briefly open the pump’s dump valve, which will allow trapped fluid pressure to evacuate.

### Automatic Pressure Relief

Select the Autodump checkbox to enable the automated pressure relief functionality. The automatic pressure relief will perform the same function as the manual pressure relief, but will trigger on its own once the pump’s outlet pressure rises above the set Pressure Limit. The system will only perform a pressure dump when the pump is in Standby or Off.

**NOTE:** It is recommended to set the Pressure Limit significantly above the spray pressure to avoid unnecessarily dumping fluid.

### Maintenance Screen 5

Maintenance screen 5 displays cycle counts for a selected color, catalyst, or solvent valve.



Press and hold the Reset button for 1-2 seconds to reset the counter.

If the system is in Standby, valves can be opened or closed by selecting or deselecting the box for the corresponding valve. Leaving this screen will close all manually-driven valves.

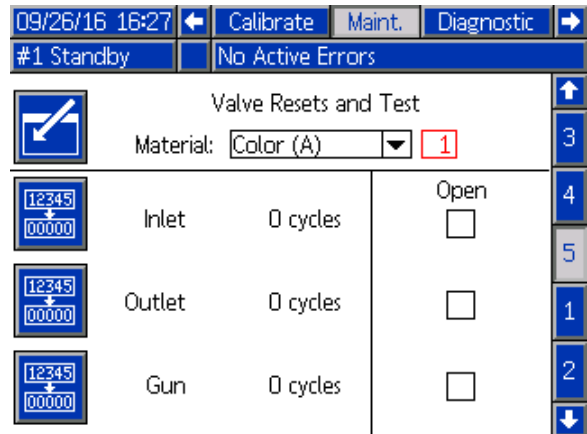

Figure 75 Maintenance Screen 5, Color Valve Resets

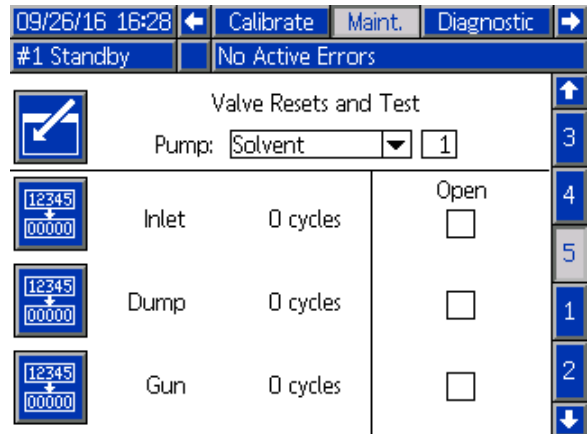

Figure 76 Maintenance Screen 5, Solvent Valve Resets

**NOTE:** In Fig. 48, the number to the right of “Solvent” is the pump number, not the material number.

## Advanced Screen 1

Advanced screen 1 sets the following display parameters.

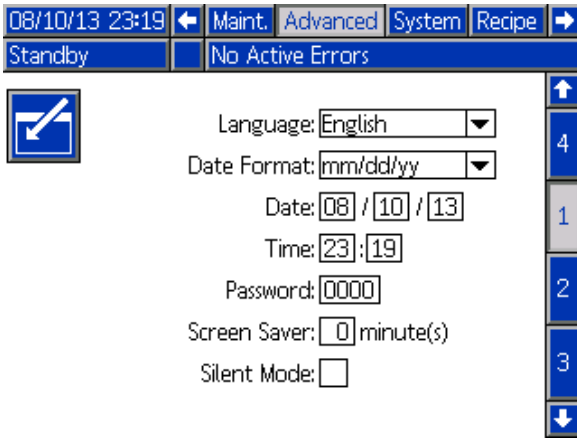

Figure 77 Advanced Screen 1

### Language

Defines the language of the screen text. Select:

- English (default)
- Spanish
- French
- German
- Japanese
- Chinese
- Korean
- Dutch
- Italian
- Portuguese
- Swedish
- Russian

### Date Format

Select mm/dd/yy, dd/mm/yy, or yy/mm/dd.

### Date

Enter the date, using the format selected. Use two digits for the month, day, and year.

### Time

Enter current time in hours (24 hour clock) and minutes. Seconds are not adjustable.

### Password

The password is only used to enter Setup mode. The default is 0000, which means no password is required to enter Setup. If a password is desired, enter a number from 0001 to 9999.

**NOTE:** Be sure to write down the password and keep it in a secure location.

### Screen Saver

Select the desired screen timeout in minutes (00-99). 5 is the default. Select zero (0) to disable the screen saver.

### Silent Mode

Select Silent Mode to disable the alarm buzzer and audible feedback.

## Advanced Screen 2

Advanced screen 2 sets display units (US or metric).

The screenshot shows the 'Advanced' screen with a navigation bar at the top containing '08/10/13 23:21', 'Maint.', 'Advanced', 'System', and 'Recipe'. Below the navigation bar, there are two status indicators: 'Standby' and 'No Active Errors'. The main content area is titled 'Units' and contains three dropdown menus: 'Grand Total: gal', 'Pressure: psi', and 'Length: ft'. A vertical navigation bar on the right side of the screen has buttons labeled 1, 2, 3, 4, and a down arrow.

Figure 78 Advanced Screen 2

### Display Units

Select the desired display units:

- Grand Total Volume (US gallon or liter)
- Pressure (psi, bar, or MPa)
- Length (ft or m)

## Advanced Screen 3

Advanced screen 3 enables USB downloads and uploads.

The screenshot shows the 'Advanced' screen with a navigation bar at the top containing '08/10/13 23:21', 'Maint.', 'Advanced', 'System', and 'Recipe'. Below the navigation bar, there are two status indicators: 'Standby' and 'No Active Errors'. The main content area contains three settings: 'Enable USB Downloads/Uploads: ', 'Download Depth: Last days', and 'Log 90% Full Advisory Enabled: '. A vertical navigation bar on the right side of the screen has buttons labeled 1, 2, 3, 4, 1, and a down arrow.

Figure 79 Advanced Screen 3

### Enable USB Downloads/Uploads

Select this box to enable USB downloads and uploads. Enabling USB activates the Download Depth field.

### Download Depth

Enter the number of days for which you want to retrieve data. For example, to retrieve data for the previous week, enter 7.

### Log 90% Full Advisory Enabled

This selection is enabled by default. When enabled, the system will issue an advisory if the memory log has reached 90% of capacity. Perform a download to avoid loss of data.

## Advanced Screen 4

Advanced screen 4 displays the software part numbers and versions for the system components. This is not an editable screen.

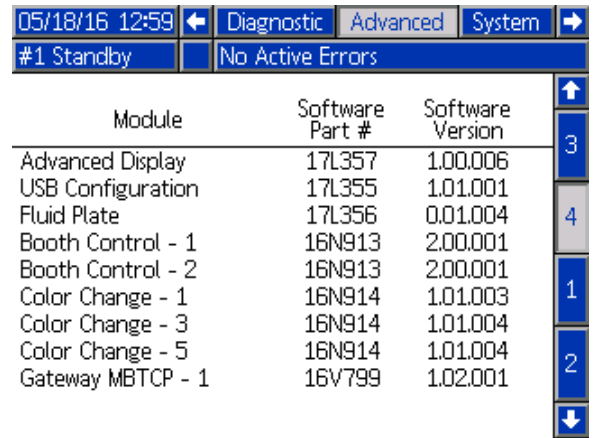

The screenshot shows a menu bar at the top with '05/18/16 12:59', 'Diagnostic', 'Advanced', and 'System'. Below the menu bar, it displays '#1 Standby' and 'No Active Errors'. The main content is a table with three columns: 'Module', 'Software Part #', and 'Software Version'. To the right of the table is a vertical navigation bar with buttons labeled 1, 2, 3, and 4, and up/down arrows.

Module	Software Part #	Software Version
Advanced Display	17L357	1.00.006
USB Configuration	17L355	1.01.001
Fluid Plate	17L356	0.01.004
Booth Control - 1	16N913	2.00.001
Booth Control - 2	16N913	2.00.001
Color Change - 1	16N914	1.01.003
Color Change - 3	16N914	1.01.004
Color Change - 5	16N914	1.01.004
Gateway MBTCP - 1	16V799	1.02.001

Figure 80 Advanced Screen 4

## Diagnostic Screens

### Diagnostic Screen 1

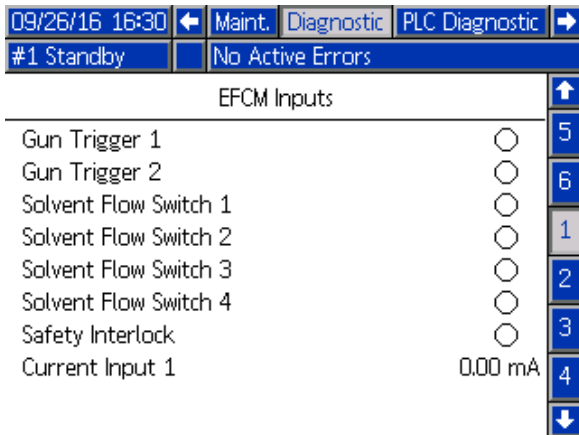

Figure 81 Diagnostic Screen 1

Use this screen to test and verify proper wiring for all inputs to the EFCM. (See installation manual for details.) The screen shows all available inputs to the EFCM, but only highlights those that are relevant to the system configuration. All inputs are normally open. When the input sees a switch closure the status indicator on the screen will turn green.

### Diagnostic Screen 2

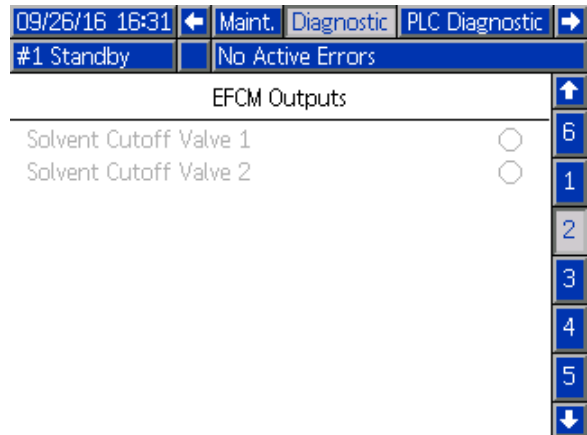

Figure 82 Diagnostic Screen 2

This screen can be used to determine whether any of the EFCM outputs are currently on or off. The screen shows all available outputs from the EFCM, but only highlights those that are relevant to the system configuration. The status indicator next to each output indicates the output is ON when it is green.

### Diagnostic Screens 3–10

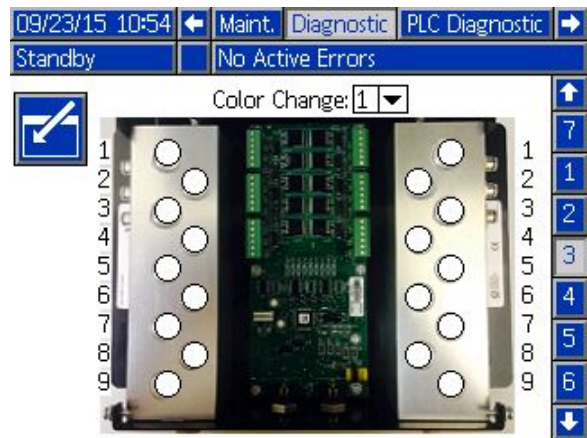

Figure 83 Diagnostic Screen 1

Diagnostic screens 3–10 are only available for color change modules that are currently connected to the PD2K system. These screens provide real time status of the color change valve outputs by changing the status indicator from white to green when the system energizes that solenoid. The user may scroll through the boards with the up and down arrows, or jump directly to a specific color change module by selecting it from the drop-down box.

# Calibration Checks

## Pump Pressure Check

**NOTE:** Enter the transducer calibration data before doing the pressure check.





### Perform the pressure check:

- The first time the system is operated.
- Whenever new materials are used in the system, especially if the materials have viscosities that differ significantly.
- At least once per month as part of regular maintenance.
- Whenever a pump is serviced or replaced.

During each pressure test, the dose valve will close during an up stroke and a down stroke (in either order). This test is to verify that the valves are seating properly and not leaking. If leaking occurs, the system will alarm after the test for that particular pump direction.

**NOTE:** Do not trigger the spray device during the pressure check.

1. The pump and lines must be primed with color or catalyst before doing the Pressure Check. See [Prime and Fill the System, page 20](#).
2. If the display is on a Run Mode screen, press  to access setup screens.
3. Scroll to Calibrate to display [Calibrate Screen 1, page 86](#).
4. Press the Pressure Check  button for the desired pump. The pump will build pressure in the line to a minimum of the Stall Test Pressure. The pump will then move to the center stroke position and stall test the upstroke, followed by the downstroke.
5. The pressure and flow that the unit measured are displayed on the screen. Compare with the maximum leak rate entered on [System Screen 5, page 72](#). If the values are substantially different, repeat the test.

**NOTE:** The stall test pressure set point is a minimum. The system may stall at a higher pressure depending on hose lengths and fluid composition.

## Pump Volume Check



1. The pump and lines must be primed with color or catalyst before doing the Volume Check. See [Prime and Fill the System, page 20](#).
2. If the display is on a Run Mode screen, press  to access setup screens.
3. Scroll to Calibrate in the menu bar.
4. Scroll to [Calibrate Screen 2, page 86](#).

5. Press the soft key  for the pump you want to check.

**NOTE:** For maximum accuracy, use a gravimetric (mass) method to determine the actual volumes dispensed. Verify that the fluid line is filled and at the proper pressure before checking. Air in the line or pressure that is too high may cause incorrect values.

6. Press the Reset key . The volume counter will reset to 0.
7. Trigger the gun into a graduated cylinder. Dispense a minimum of 500cc of material.
8. The volume that the unit measured displays on the screen.
9. Compare the amount on the screen to the amount in the graduated cylinder.

**NOTE:** If the value is substantially different, repeat the test. If the dispensed volume and measured volume still do not match, check that the A and B pump positions are not reversed.

**NOTE:** Stop triggering the gun and press  to cancel the test.

## Solvent Meter Calibration

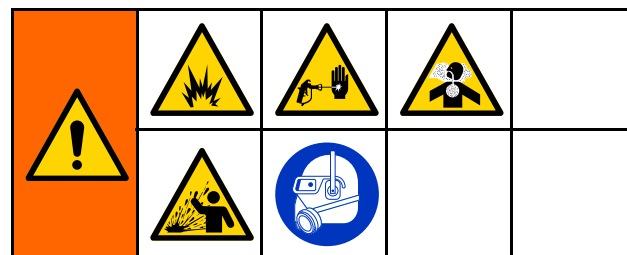



1. The meter and lines must be primed with solvent before doing the calibration. See [Prime and Fill the System, page 20](#).
2. If the display is on a Run Mode screen, press  to access setup screens.
3. Scroll to Calibrate in the menu bar.
4. Scroll to [Calibrate Screen 3, page 87](#).

5. Press the soft key  to initiate the calibration.

**NOTE:** For maximum accuracy, use a gravimetric (mass) method to determine the actual volumes dispensed.

**NOTE:** Verify that the fluid line is filled and at the proper pressure before calibrating. Air in the line or pressure that is too high may cause incorrect calibration values.

6. Trigger the gun into a graduated cylinder. Dispense a minimum of 500cc of material.
7. The volume that the unit measured displays on the screen.
8. Compare the amount on the screen to the amount in the graduated cylinder.
9. Enter the amount of solvent dispensed in the Measured Volume field on the screen.
10. After the measured volume is entered, the controller calculates the new solvent meter K-factor and displays it on the screen. The standard meter K-factor is 0.021 cc/pulse.

11. Press  to accept the calibration. Press  to cancel the calibration and retain the previous K-factor.

**NOTE:** Solvent meters must be enabled individually by Mix Unit. Solvent Meter 1 applies to Mix Unit #1 only, Solvent Meter 2 applies to Mix Unit #2 only.

## Color Change

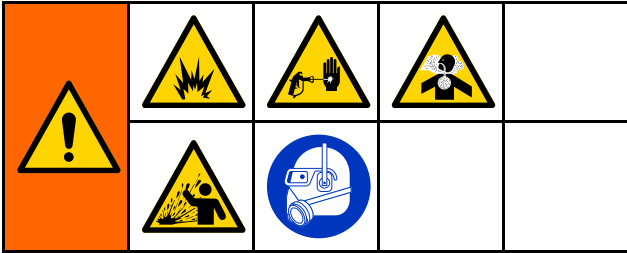

Color Change Module Kits are available as an accessory. See manual 333282 for complete information.

### Multiple Color Systems

1. Command the system to Standby.
2. Enable manual override on [System Screen 1, page 68](#).
3. Select the new recipe on the [Spray Screen, page 64](#). This will change colors in the pump and initiate a gun purge.
4. The system will purge material B then material A out of the gun. Each material will purge for the amount of time designated by the Flush Sequence selected for each material on the [Recipe Screen, page 74](#).
5. Wait for the color change to complete. The system automatically goes from Color Change to Mix Fill and the remote mix manifold automatically selects the correct color.
6. Trigger the gun to complete the Mix Fill.  
**NOTE:** There is a 10 second delay without flow before the system will fault.
7. Wait for the system to complete the Mix Fill operation. Command the system to Mix and begin spraying..



# System Errors

System errors alert you of a problem and help prevent off-ratio spraying. There are three types: Advisory, Deviation, and Alarm.

An **Advisory** records an event in the system, and will clear itself after 60 seconds. The four-digit error code will be followed by '-V'.

A **Deviation** records an error in the system but does not shut down the equipment. The deviation must be acknowledged by the user. The four-digit error code will be followed by '-D'.

If an **Alarm** occurs, operation stops. The four-digit error code will be followed by '-A'.

If any of the system error types occur:

- Alarm buzzer sounds (unless in silent mode).
- Alarm popup screen shows the active alarm code (see [Error Codes](#), page 99).
- Status bar on the Advanced Display Module shows the active alarm code.
- Alarm is saved in the date/time stamped log.

A **Record** saves relevant system events in the background. These are informational only and can be reviewed on the Events screen, which displays the 200 most recent events, with date, time, and description.

**NOTE:** Most system errors apply only to a specific Mix Unit and therefore only show up on the appropriate menu bar and Event Flag PLC register when that Mix Unit is active. All alarms will generate a pop-up on the ADM regardless of the active Mix Unit.

## On-Screen Help

When a system alarm occurs, a help screen is available to provide timely and relevant troubleshooting information for the user. On the

alarm popup screen, press  to access the help screens. The help screens may also be accessed at any time by going to the Errors Screen and selecting an alarm in the log (see [Errors Screen](#), page 67).

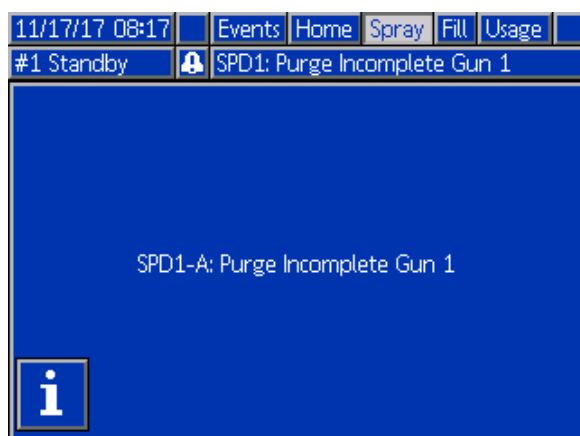



Figure 84 Alarm Popup  
3A4486B

All alarms have a QR code screen. A mobile device with internet access and a QR reader may use the QR code to access additional information on a webpage hosted by help.graco.com.



Figure 85 QR Code Screen

A number of the alarms that are most likely to be encountered during typical operation have detailed troubleshooting information screens. The troubleshooting screens will replace the QR code screen, though the QR code may still be accessed by

pressing .

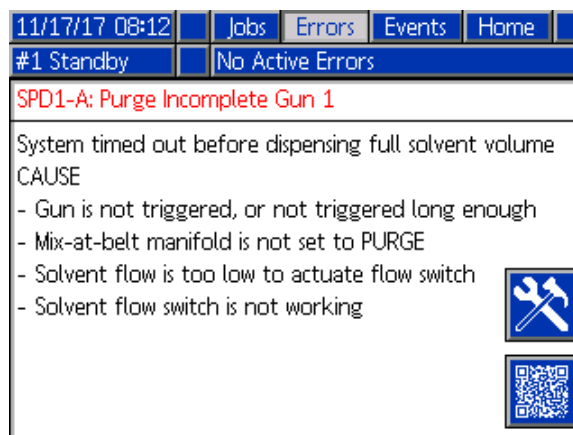



Figure 86 Troubleshooting Screen

## To Clear Error and Restart

**NOTE:** When a deviation or alarm occurs, be sure to determine the error code before resetting it. If you forget which code occurred, go to the [Errors Screen, page 67](#), to view the last 200 errors, with date and time stamps.

If an alarm has occurred, correct the cause before resuming operation.

To acknowledge a deviation or clear an alarm, press

 on the Advanced Display Module. Users also may acknowledge and clear errors via a network device (see [INPUT REGISTER 01 and 11: Clear Active Alarm/Deviation, page 35](#)).

## Gun Trigger Input Function

The Gun Trigger Input signals the controller when the gun is triggered. The gun icon on the Advanced Display Module shows spray when the Gun Trigger Input is activated.

If a pump fails, pure resin or catalyst could spray indefinitely if the unit does not detect the condition and intervene, which is why the Gun Trigger Input is so important.

If the unit detects through the Gun Trigger Input signal that the gun is triggered, yet one or both of the pumps are not running, a Flow Not Detected Alarm (F8D1) occurs after 10 seconds (default) and the system goes into Standby.

## Error Codes

**NOTE:** When an error occurs be sure to determine the code before resetting it. If you forget which code occurred, use the [Errors Screen, page 67](#) to view the last 200 errors, with date, time, and description.

### Purge Errors

Code	Type	Description	Problem	Cause	Solution
EJS#	Record	Purge Not Complete	The Mix Unit was unable to complete a purge sequence.	An indication that Mix Unit # either could not complete or was interrupted before completing a gun purge.	No action required.
SPD#	Alarm	Gun Purge Incomplete	The Mix Unit timed out without reaching the user-specified volume of solvent for a purge.	Solvent flow switch not working.	Replace switch.
				Solvent flow is too low to actuate the solvent switch.	Increase solvent pressure to drive a high purge flow rate
				Gun is not triggered.	Operator must continue flushing for configured time, until the booth control indicates purge is completed.
				Mix manifold was not set to flush position, blocking solvent flow to the spray gun.	Set manifold to flush position.

### Mix Errors

Code	Type	Description	Problem	Cause	Solution
F7S1 F7S2	Alarm	Flow Detected Solvent Gun	The solvent flow switch is indicating unexpected solvent flow for Mix Unit (1) or Mix Unit (2).	Solvent flow switch is stuck in flow position.	Clean or replace switch.
				There is a leak through the solvent cutoff valve.	Check for leaks and repair valve.
F7S3 F7S4	Alarm	Flow Detected Solvent Mix	The solvent flow switches indicate that both are flowing solvent at the same time for Mix Unit #1 (3) or Mix Unit #2 (4).	One or both solvent flow switches are stuck in flow position.	Clean or replace the switch(es).
				There is a leak through one or both of the solvent cutoff valves.	Check for leaks and repair valve(s).
QPD#	Alarm, then Deviation	Potlife Expired	Potlife time has expired before the Mix Unit has moved the required amount of material (potlife volume) through the mixed material line.	Purge process was not completed.	Make sure purge process is completed.
				Solvent supply shut off or empty.	Verify solvent supply is available and on, supply valves are open.
SND#	Alarm	Mix Fill Incomplete	Mix Unit # timed out before the mix fill cycle loaded the gun with mixed material.	Mix manifold not set to spray position.	Set manifold to spray.
				Spray gun was not triggered.	Allow flow through gun during fill process until the fill complete LED stops flashing.
				Restrictions in mixer, manifold, or spray gun.	Fix restrictions.

**Pumping Errors**

**NOTE:** In some error codes listed below, a # symbol is shown as the last digit. This symbol represents the applicable component number, which can vary. The unit's display will show the applicable number as the last digit in the code. For example, the F1S# code listed in this table will be displayed as F1S1 if the affected component is pump 1, F1S2 for pump 2, and so on.

Code	Type	Description	Problem	Cause	Solution
DA0#	Alarm	Exceeded Maximum Flow Pump #	Pump was driven to its maximum allowed speed.	System has a leak or open valve that is allowing unrestricted flow.	Inspect system for leaks.
				Pump is cavitating, cycling without restriction.	Verify that the pump is being supplied with material.
				Viscosity of material is too thin for nozzle size.	Reduce nozzle size to create more restriction. Reduce paint pressure to lower the flow rate.
				System pressure or Flow Setpoint is too high (causing the pump to work too hard).	Reduce the pressure or the Flow Setpoint.
DE0#	Alarm	Leak Detected Pump #	This is a manual stall test failure when the pump cannot build pressure to the target "Stall Test Pressure." Will fault after 30 seconds.	No material in the pump or line.	Make sure the pump and down stream color line are loaded with material.
				Leak in the system.	Determine if leak is external or internal by visually inspecting the system for fluid leakage. Fix all loose or worn hoses, fittings, and seals. Inspect all valve seats and needles for wear, and replace worn piston or throat seals.
DF0#	Alarm	No Stall Up Pump #	Pump failed the stall test; did not stall on the upstroke.	Valve failure, seal failure, worn rod or cylinder.	Replace inlet and outlet valve and seal for up stroke. Replace piston and throat seals. Replace rod and cylinder as necessary.
DG0#	Alarm	No Stall Down Pump #	Pump failed the stall test; did not stall on the downstroke.	Valve failure, seal failure, worn rod or cylinder.	Replace inlet and outlet valve and seal for down stroke. Replace piston and throat seals. Replace rod and cylinder as necessary.
DH0#	Alarm	No Stall Pump #	Pump failed the stall test; did not stall on either the upstroke or the downstroke.	Valve failure, seal failure, worn rod or cylinder.	Replace inlet and outlet valve and seal for up and down strokes. Replace piston and throat seals. Replace rod and cylinder as necessary.

Code	Type	Description	Problem	Cause	Solution
DKD#	Alarm	Position Failed Pump #	Pump was unable to reach its drive position.	Not enough air is supplied to the dosing valves.	Ensure that at least 85 psi is being supplied to the dosing valves.
				The pressure at the pump outlet is too high.	Check for an obstruction downstream of the pump that would increase pressure. Ensure the feed pressure is within 1/2 – 1/3 of the target pressure
DKF#	Alarm	Position Overspeed Pump #	Pump moved beyond its drive position.	The pump was knocked out of position.	There is no fluid pressure at the outlet of the pump; run the pump at a lower pressure to fill the lines. Check that the feed pressure is not more than the target pressure.
EBH#	Record	Home Complete Pump #	Record of pump homing is complete.	An indication on the display that the pump completed the home function	No action required.
EF0#	Alarm	Timeout Startup Pump #	Pump tried but was not able to move to the home position within a specified amount of time.	Pump dose valves did not actuate.	Verify air pressure to solenoid valves. Verify the valves are actuating.
				Motor could not drive pumps and linear actuator.	Verify motor is driving the pump.
				Pump stroke length is shortened by mechanical system tolerance.	Verify correct assembly of linear actuator and pump piston rods. See pump manual.
EF1#	Alarm	Timeout Shutdown Pump #	Pump tried but was not able to move to the park position within a specified amount of time.	Pump dose valves did not actuate.	Visually inspect valves to ensure they are operating properly; verify they have air pressure above 85 psi (0.6 MPa, 6.0 bar).
				Pump is filled with thick paint and could not drive piston to end of stroke. Motor or drive is worn or damaged.	Observe motor and drive assembly to verify that the motor is generating force.
ETD#	Record	Auto Pressure Relief Pump #	Record of pump completing an auto pressure relief.	Pump outlet pressure exceeded relief threshold.	No action required.
EP0#	Record	Auto Pump Parked Mix Unit #	Record of pumps being auto parked.	The auto pump park operation was completed.	No action required.
F1A#	Alarm	Flow Low Dispense Pump #	The pump was unable to maintain its target flow rate.	There is a restriction in the hose or gun that is preventing the pump from dispensing at its target rate.	Check that the gun is triggered and for restrictions in the hose.
F1D#	Alarm	Flow Low Mix Unit #	The Mix Unit was unable to maintain its target flow rate.	There is a restriction in the hose or gun that is preventing the pump from dispensing at its target rate.	Check that the gun is triggered and for restrictions in the hose.

## System Errors

Code	Type	Description	Problem	Cause	Solution
F1F#	Alarm	Flow Low Fill Pump #	There has been no flow or low flow during a pump fill operation.	There is a restriction on the outlet side of the pump or color stack.	Make sure there are no restrictions in the color stack and that the dump valve is actuating.
				Thick viscosity paint requires more pressure to pump.	Increase non-mix pressure if necessary to create flow during the fill function.
				The pumps do not have to move for the system to build enough pressure to meet the setpoint.	Increase non-mix pressure if necessary to create flow during the fill function.
F1S#	Alarm	Flow Low Purge Pump #	There has been no flow or low flow during a pump purge operation.	Restriction in the outlet side of the pump or color stack resulting in the solvent flow being too low.	Make sure there are no restrictions in the system. Increase non-mix pressure if necessary to create flow during the purge function.
F7D#	Alarm	Flow Detected Pump #	The pump flow exceeded 20 cc/min flow coming into Idle mode.	There is a leak in the system or the gun was open when the system went into Idle mode.	Verify there are no leaks in the system. Make sure the air flow switch is actuating properly. Do not trigger the gun without atomizing air.
F8D#	Alarm	Flow Not Detected Mix Unit #	No flow while mixing.	Restriction in the outlet side of the pump or color stack.	Make sure there are no restrictions in the system.
F9D#	Alarm	Flow Unstable Pump #	The pump flow rate did not stabilize while entering Idle mode.	Potential leak in the system.	Check the system for leaks and run manual stall test.

## Pressure Errors

**NOTE:** In some error codes listed below, a # symbol is shown as the last digit. This symbol represents the applicable component number, which can vary. The unit's display will show the applicable number as the last digit in the code. For example, the P6F# code listed in this table will be displayed as P6F1 if the affected component is pump 1, P6F2 for pump 2, and so on.

Code	Type	Description	Problem	Cause	Solution
P1D#	Alarm	Pressure Low Outlet Pump #	The outlet pressure on pump # is less than the user-entered alarm limit. *This alarm is only enabled with Flow Control.	There is no fluid pressure or pump is cavitating.	Check supply for pump #, increase supply pressure.
P1F#	Alarm	Pressure Low Inlet Pump #	The inlet pressure on pump # is less than the user-entered alarm limit.		Increase inlet pressure.
P2F#	Deviation	Pressure Low Inlet Pump #	The inlet pressure on pump # is less than the user-entered deviation limit.		Increase inlet pressure.
P3D#	Deviation	Pressure High Outlet Pump #	The outlet pressure on pump # is greater than the user entered deviation limit.		Relieve system pressure.
P3F#	Deviation	Pressure High Inlet Pump #	The inlet pressure on pump # is greater than the user-entered deviation limit.		Decrease inlet pressure.
P4D#	Alarm	Pressure High Outlet Pump #	The outlet pressure on pump # is greater than the user entered alarm limit.		Relieve system pressure.
P4F#	Alarm	Pressure High Inlet Pump #	The inlet pressure on pump # is greater than the user-entered alarm limit.		Decrease inlet pressure.
P4P#	Alarm	Pressure High Supply Pump #	The supply pump fluid pressure for pump # is greater than 90% of the user-entered Stall Test Pressure.	The supply pump pressure is too high.	Check supply for pump #, decrease supply pressure.
P6D#	Alarm	Press. Sens. Removed Outlet #	No outlet pressure transducer is detected when the system is expecting one.	Disconnected transducer.	Verify transducer is connected properly. Replace if reconnecting does not eliminate the alarm.
P6F#	Alarm	Press. Sens. Removed Inlet #	No inlet pressure transducer is detected when the system is expecting one.	Disconnected transducer.	Verify transducer is connected properly. Replace if reconnecting does not eliminate the alarm.
P9D#	Alarm	Press. Sens. Failed Outlet #	Outlet pressure transducer has failed.	Outlet pressure transducer has failed or the pressure is above the readable range.	Relieve system pressure. Verify connections, or replace if reconnecting does not eliminate the alarm.
P9F#	Alarm	Press. Sens. Failed Inlet #	Inlet pressure transducer has failed.	Inlet pressure transducer has failed or the pressure is above the readable range.	Relieve system pressure. Verify connections, or replace if reconnecting does not eliminate the alarm.

## System Errors

Code	Type	Description	Problem	Cause	Solution
QAD#	Alarm	Differential Pressure A Over B	Mix Unit # low differential pressure. This alarm is active only during Mix mode.	There is a leak on the B side.	Check the system for internal and external leaks on all catalyst manifolds and plumbing.
				The B side pump is cavitating.	Check paint supply on the B side, increase paint supply pressure.
QBD#	Alarm	Differential Pressure B Over A	Mix Unit # high differential pressure. This alarm is active only during Mix mode.	There is a leak on the A side.	Check the system for internal and external leaks on all color manifolds and plumbing.
				The A side pump is cavitating.	Check paint supply on the A side, increase paint supply pressure.

## System Errors

Code	Type	Description	Problem	Cause	Solution
EB00	Record	Stop Button Pressed	Record of a stop button press.	Indicates system stop key on ADM was pressed.	n/a
EBC#	Record	PLC Power Command for Mix Unit #	Record of pumps powered off by PLC command.	The PLC command was used to shut down pump power.	No action required.
EBI#	Record	Power Button Pressed Mix Unit #	Record of pumps powered off by button press.	The power button on the ADM was used to shut down pump power.	No action required.
EC00	Record	Setup Value(s) Changed	Record of changing setup variables.	Indicates date and time when setup values were changed.	n/a
EL00	Record	System Power On	Record of power cycle (ON).	Indicates date and time when system was started.	n/a
EM00	Record	System Power Off	Record of power cycle (OFF).	Indicates date and time when system was turned off.	n/a
EMI#	Advisory	Pump Off Mix Unit #	The pumps are not powered and are unable to move for Mix Unit #.	Pump power was turned off or an error occurred.	Start pumps by pressing pump start key on Advanced Display module.
ES00	Advisory	Factory Defaults	Record of defaults being loaded.		n/a



## Communication Errors

**NOTE:** In some error codes listed below, a # symbol is shown as the last digit. This symbol represents the applicable component number, which can vary. The unit's display will show the applicable number as the last digit in the code. For example, the CAC# code listed in this table will be displayed as CAC1 if the affected component is color change board 1, CAC2 for board 2, and so on.

Code	Type	Description	Problem	Cause	Solution
CA0X	Alarm	Comm. Error ADM	System does not detect the Advanced Display Module (ADM).	This communication error indicates that the Network has lost communication with the Advanced Display Module.	Check CAN cable connecting ADM to the EFCM.
CAC#	Alarm	Comm. Error Color Change #	System does not detect the Color Change Module #.	This communication error indicates that the network has lost communication with the Color Change Module #.	Check CAN cable connections to the Color Change Module # and any interconnected modules.
CADX	Alarm	Comm. Error Fluid Module	System does not see the Enhanced Fluid Control Module (EFCM).	This communication error indicates that the Network has lost communication with the EFCM.	Check CAN cables connecting ADM to the EFCM. Replace Cable or EFCM as necessary.
CAGX	Alarm	Comm. Error Gateway	System does not detect a CGM that was registered as being connected at power up.		
CAG#	Alarm	Comm. Error Modbus Gateway	System does not detect a Modbus CGM that was registered as being connected at power up.	The Modbus CGM address dial was changed while the system was powered up.	Unplug the Modbus CGM from the CAN network and re-plug it back in so that it re-registers with the new address.
				The Modbus CGM is not connected/failed.	Check that the Modbus CGM is properly connected to the CAN network and it's LEDs indicate it is powered.
CDC#	Alarm	Duplicate Color Change #	System detects two or more identical Color Change Modules.	More than one Color Change Module with the same address is connected in the system .	Check the system and remove the extra color change module.
CDDX	Alarm	Duplicate Fluid Module	System sees two or more identical Enhanced Fluid Control Modules (EFCM).	More than one EFCM is connected in the system.	Check the system and remove the extra EFCM.

**USB Errors**

Code	Type	Description	Problem	Cause	Solution
EAUX	Advisory	USB Busy	USB drive is inserted, download is in progress.	Indicates USB port is uploading or downloading data.	Wait for USB Idle.
EBUX	Record	USB Drive Removed	USB drive was removed while downloading or uploading.	Downloading/uploading data on USB was interrupted by the USB device being removed.	Replace the USB device and begin process again.
EQU0	Advisory	USB Idle	USB download completed, drive may be removed.	Data transfer is completed to the USB device.	Remove USB device from ADM.
EQU1	Record	USB Sys. Settings Downloaded	Settings were downloaded to USB drive.	User installed USB device in ADM USB port.	n/a
EQU2	Record	USB Sys. Settings Uploaded	Settings were uploaded from USB drive.	User installed USB device in ADM USB port.	n/a
EQU3	Record	USB Custom Lang. Downloaded	Custom language was downloaded to USB drive.	User installed USB device in ADM USB port.	n/a
EQU4	Record	USB Custom Lang. Uploaded	Custom language was uploaded from USB drive.	User installed USB device in ADM USB port.	n/a
EQU5	Record	USB Logs Downloaded	Data logs were downloaded to USB drive.	User installed USB device in ADM USB port.	n/a
EVUX	Advisory	USB Disabled	USB drive has been inserted, downloading is disabled.	Configuration of system is blocking data transfer.	Change configuration to enable USB download function.
MMUX	Advisory	Maint. USB Logs Full	USB memory is more than 90% full.	Configuration parameter on system is enabled to generate this advisory.	Complete download to ensure no data is lost.
WSUX	Advisory	USB Config. Err.	USB configuration file does not match expected; checked on startup.	A software update was not completed successfully.	Reinstall software.
WXUD	Advisory	USB Download Err.	An error occurred while downloading to the USB drive.	User installed incompatible USB device in ADM USB port.	Repeat process with compatible USB device.
WXUU	Advisory	USB Upload Err.	An error occurred while uploading from the USB drive.	User installed incompatible USB device in ADM USB port.	Repeat process with compatible USB device.

## Miscellaneous Errors

**NOTE:** In some error codes listed below, a # symbol is shown as the last digit. This symbol represents the applicable component number, which can vary. The unit's display will show the applicable number as the last digit in the code. For example, the B9D# code listed in this table will be displayed as B9D1 if the affected component is pump 1, B9D2 for pump 2, and so on.

Code	Type	Description	Problem	Cause	Solution
B9A#	Advisory	Volume Rollover A Current Mix Unit #	Batch counter for material A rolled over for Mix Unit #.	The totalizer has reached maximum capable value and started over at zero.	n/a
B9AX	Advisory	Volume Rollover A Lifetime	Grand total counter for material A rolled over.	The totalizer has reached maximum capable value and started over at zero.	n/a
B9B#	Advisory	Volume Rollover B Current Mix Unit #	Batch counter for material B rolled over for Mix Unit #.	The totalizer has reached maximum capable value and started over at zero.	n/a
B9BX	Advisory	Volume Rollover B Lifetime	Grand total counter for material B rolled over.	The totalizer has reached maximum capable value and started over at zero.	n/a
B9D#	Advisory	Volume Rollover Pump #	Grand total counter for pump # rolled over.	The totalizer has reached maximum capable value and started over at zero.	n/a
B9S1 B9S2	Advisory	Volume Rollover Solvent Current Mix Unit #	Batch counter for solvent rolled over for Mix Unit 1 (1) or Mix Unit 2 (2).	The totalizer has reached maximum capable value and started over at zero.	n/a
B9S3 B9S4	Advisory	Volume Rollover Solvent Lifetime	Grand total counter for solvent rolled over for Mix Unit 1 (3) or Mix Unit 2 (4).	The totalizer has reached maximum capable value and started over at zero.	n/a
WX00	Alarm	Software Errors	An unexpected software error has occurred.		Call Graco technical support.

## Calibration Errors

**NOTE:** In some error codes listed below, a # symbol is shown as the last digit. This symbol represents the applicable component number, which can vary. The unit's display will show the applicable number as the last digit in the code. For example, the ENT# code listed in this table will be displayed as ENT1 if the affected component is pump 1, ENT2 for pump 2, and so on.

Code	Type	Name	Description
END#	Record	Calibration Pump #	A calibration test was run on the pump.
ENS#	Record	Calibration Solvent Meter #	A calibration test was run on the solvent meter.
ENT#	Record	Calibration Stall Test Pump #	A stall test was completed successfully on pump #.

**Maintenance Errors**

**NOTE:** In some error codes listed below, a # symbol is shown as the last digit. This symbol represents the applicable component number, which can vary. For example, the MAD# code listed in this table will be displayed as MAD1 if the affected component is pump 1, MAD2 for pump 2, and so on.

Because some components are assigned a 2–digit number, the last digit of the code is displayed as an alphanumeric character. The second table below correlates the alphanumeric digit to its component number. For example, code MEDZ represents outlet valve 30.

Code	Type	Name	Description
MAD#	Advisory	Maint. Outlet Pump #	Maintenance is due on pump.
MAT#	Advisory	Maint. Stall Test Pump #	Maintenance stall test is due on pump.
MEB#	Advisory	Maint. Valve Catalyst (B) #	Maintenance is due on catalyst valve.
MED#	Advisory	Maint. Valve Outlet #	Maintenance is due on outlet valve.
MEF#	Advisory	Maint. Valve Inlet #	Maintenance is due on inlet valve.
MEG#	Advisory	Maint. Valve Gun #	Maintenance is due on gun valve.
MEN#	Advisory	Maint. Valve Auxiliary	Maintenance is due on auxiliary valve.
MES#	Advisory	Maint. Valve Solvent #	Maintenance is due on solvent valve.
MFF#	Advisory	Maint. Meter Flow #	Maintenance is due on flow meter.
MFS#	Advisory	Maint. Meter Solvent #	Maintenance stall test is due on solvent meter.
MGH0	Advisory	Maint. Filter Fluid	Maintenance is due on fluid filter.
MGP0	Advisory	Maint. Filter Air	Maintenance is due on air filter.
MJP#	Advisory	Maint. Valve Air	Maintenance is due on air valve.

**Alphanumeric Last Digits**

Alphanumeric Digit	Component Number
1	1
2	2
3	3
4	4
5	5
6	6
7	7
8	8
9	9
A	10
B	11
C	12
D	13
E	14
F	15

Alphanumeric Digit	Component Number
G	16
H	17
J	18
K	19
L	20
M	21
N	22
P	23
R	24
T	25
U	26
V	27
W	28
Y	29
Z	30

# Maintenance

## Preventive Maintenance Schedule

The operating conditions of your particular system determine how often maintenance is required. Establish a preventive maintenance schedule by recording when and what kind of maintenance is needed, and then determine a regular schedule for checking your system.

## Flushing

- Flush before changing fluids, before fluid can dry in the equipment, at the end of the day, before storing, and before repairing equipment.
- Flush at the lowest pressure possible. Check connectors for leaks and tighten as necessary.
- Flush with a fluid that is compatible with the fluid being dispensed and the equipment wetted parts.

## Cleaning the ADM

Use any alcohol-based household cleaner, such as glass cleaner, to clean the ADM.

# Appendix A: Integration with Allen Bradley PLC

This appendix outlines how to integrate a ProMix PD2K with an Allen Bradley Studio 5000 Programmable Logic Controller (PLC).

To integrate, the ProMix PD2K must have the Ethernet/IP protocol for PLC CGM (Graco Part number CGMEPO) installed prior to performing this procedure.

In the PLC software, perform the following steps:

1. Add the new Ethernet module.

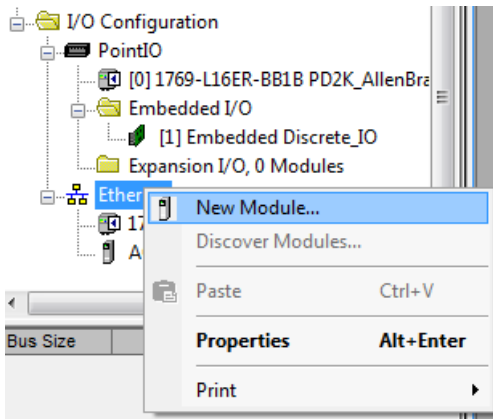

2. The **Select Module Type** screen opens.

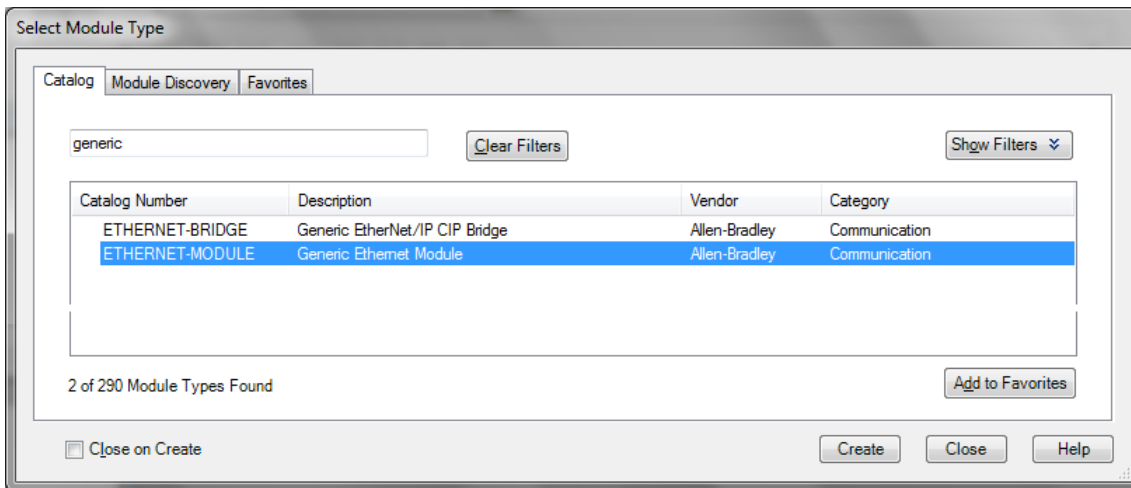

- a. In the search field, type "generic" .
- b. Select ETHERNET-MODULE Generic Ethernet Module.  
**NOTE:** Do not select the Close on Create checkbox.
- c. Click the Create button.

3. The **New Module** screen opens.

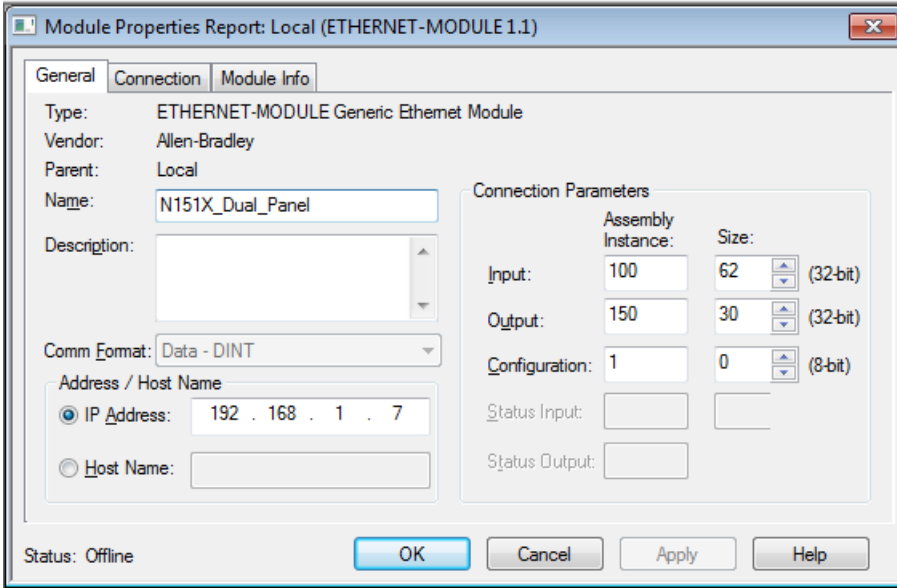

Configure the module by defining the fields as follows:

**NOTE:** The Open Module Properties checkbox must remain selected so that the configuration can be completed after completing this screen.

- a. Name (required): Enter a name for the module (select a name that will have meaning for you when viewed on the Ethernet directory shown by the figure in step 1).
- b. Description (optional): Use any description desired.
- c. IP Address (required): Enter the static IP address of the Graco EtherNet/IP CGM installed in the ProMix PD2K.
- d. Input: Assembly Instance (required): Enter “100”, which is a device-specific parameter for the Graco EtherNet/IP CGM.
- e. Input: Size (required): Enter “62”, which is the number of 32-bit registers that are allocated for input variables in the Graco EtherNet/IP CGM.
- f. Output: Assembly Instance (required): Enter “150”, which is the device-specific parameter for the Graco EtherNet/IP CGM.
- g. Output: Size (required): Enter “30”, which is the number of 32-bit registers that are allocated for output variables in the Graco EtherNet/IP CGM.
- h. Configuration: Assembly Instance (required): Enter “1”.
- i. Configuration: Size (required): Enter “0”.
- j. Click the OK button. The **Module Properties Report** window will be displayed.

4. On the Connection tab:

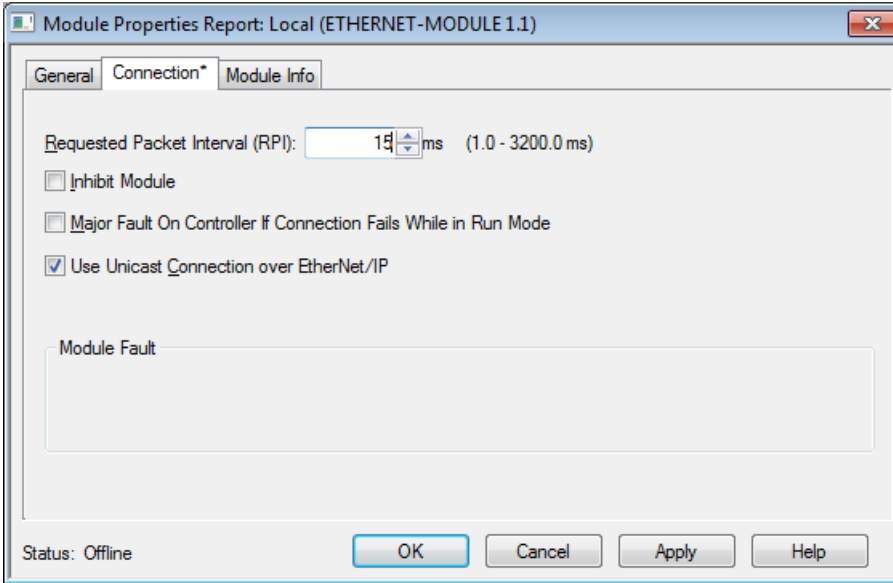

**NOTE:** An asterisk appears after the tab heading if unsaved changes are present. Click the Apply button to save changes without exiting this screen.

- a. Enter a Requested Packet Interval (RPI) value.  
**NOTE:** Graco recommends a value of 30 ms or greater.
- b. If desired, select the available checkboxes.
- c. Click the OK button to save all changes and exit this screen.

**Table 7 Potential Configuration Problems**

Error	Description
Connection Request Error — Invalid Input Application Path	This error, which also triggers an I/O Fault on the PLC, is caused by an invalid number being entered for the <b>Input: Assembly Instance</b> parameter. The correct value for this parameter is "100".
Connection Request Error — Invalid Output Application Path	This error, which also triggers an I/O Fault on the PLC, is caused by an invalid number being entered for the <b>Output: Assembly Instance</b> parameter. The correct value for this parameter is "150".
Connection Request Error — Invalid Input Size	This error, which also triggers an I/O Fault on the PLC, is caused by an invalid number being entered for the <b>Input: Size</b> parameter. The correct value for this parameter is "62".
Connection Request Error — Invalid Output Size	This error, which also triggers an I/O Fault on the PLC, is caused by an invalid number being entered for the <b>Output: Size</b> parameter. The correct value for this parameter is "30".
Module Configuration Rejected — Format Error	This error, which also triggers an I/O Fault on the PLC, is caused by an invalid number being entered for the <b>Configuration: Size</b> parameter. Because there are no configuration registers associated with the module, the correct value for this parameter is "0".



# Technical Data

Positive Displacement Proportioner	U.S.	Metric
Maximum fluid working pressure:		
AC1002 and AC3002 Air Spray Systems	300 psi	2.1 MPa, 21 bar
AC2002 and AC4002 Air-Assisted Spray Systems	1500 psi	10.5 MPa, 105 bar
Maximum working air pressure:	100 psi	0.7 MPa, 7.0 bar
Air supply:	85–100 psi	0.6–0.7 MPa, 6.0–7.0 bar)
Air filter inlet size:	3/8 npt(f)	
Air filtration for air logic (user-supplied):	5 micron (minimum) filtration required; clean and dry air	
Air filtration for atomizing air (user-supplied):	30 micron (minimum) filtration required; clean and dry air	
Mixing ratio range:	0.1:1 — 50:1, ±1%	
Fluids handled:	one or two component: <ul style="list-style-type: none"> <li>• solvent and waterborne paints</li> <li>• polyurethanes</li> <li>• epoxies</li> <li>• acid catalyzed varnishes</li> <li>• moisture sensitive isocyanates</li> </ul>	
Viscosity range of fluid:	20–5000 centipoise	
Fluid filtration (user-supplied):	100 mesh minimum	
Maximum fluid flow:	800 cc/minute (depending on material viscosity)	
Fluid outlet size:	1/4 npt(m)	
External power supply requirements:	90 - 250 Vac, 50/60 Hz, 7 amps maximum draw 15 amp maximum circuit breaker required 8 to 14 AWG power supply wire gauge	
Operating temperature range:	36 to 122°F	2 to 50°C
Storage temperature range:	–4 to 158°F	–20 to 70°C
Weight (approximate):	195 lb	88 kg
Sound data:	Less than 75 dB(A)	
Wetted parts:		
AC1002 and AC2002	17–4PH, 303, 304 SST, Tungsten carbide (with nickel binder), perfluoroelastomer; PTFE, PPS, UHMWPE	
AC4002	316 SST, 17–4PH SST, PEEK, perfluoroelastomer; PTFE, PPS, UHMWPE	

# Graco Standard Warranty

Graco warrants all equipment referenced in this document which is manufactured by Graco and bearing its name to be free from defects in material and workmanship on the date of sale to the original purchaser for use. With the exception of any special, extended, or limited warranty published by Graco, Graco will, for a period of twelve months from the date of sale, repair or replace any part of the equipment determined by Graco to be defective. This warranty applies only when the equipment is installed, operated and maintained in accordance with Graco's written recommendations.

This warranty does not cover, and Graco shall not be liable for general wear and tear, or any malfunction, damage or wear caused by faulty installation, misapplication, abrasion, corrosion, inadequate or improper maintenance, negligence, accident, tampering, or substitution of non-Graco component parts. Nor shall Graco be liable for malfunction, damage or wear caused by the incompatibility of Graco equipment with structures, accessories, equipment or materials not supplied by Graco, or the improper design, manufacture, installation, operation or maintenance of structures, accessories, equipment or materials not supplied by Graco.

This warranty is conditioned upon the prepaid return of the equipment claimed to be defective to an authorized Graco distributor for verification of the claimed defect. If the claimed defect is verified, Graco will repair or replace free of charge any defective parts. The equipment will be returned to the original purchaser transportation prepaid. If inspection of the equipment does not disclose any defect in material or workmanship, repairs will be made at a reasonable charge, which charges may include the costs of parts, labor, and transportation.

**THIS WARRANTY IS EXCLUSIVE, AND IS IN LIEU OF ANY OTHER WARRANTIES, EXPRESS OR IMPLIED, INCLUDING BUT NOT LIMITED TO WARRANTY OF MERCHANTABILITY OR WARRANTY OF FITNESS FOR A PARTICULAR PURPOSE.**

Graco's sole obligation and buyer's sole remedy for any breach of warranty shall be as set forth above. The buyer agrees that no other remedy (including, but not limited to, incidental or consequential damages for lost profits, lost sales, injury to person or property, or any other incidental or consequential loss) shall be available. Any action for breach of warranty must be brought within two (2) years of the date of sale.

**GRACO MAKES NO WARRANTY, AND DISCLAIMS ALL IMPLIED WARRANTIES OF MERCHANTABILITY AND FITNESS FOR A PARTICULAR PURPOSE, IN CONNECTION WITH ACCESSORIES, EQUIPMENT, MATERIALS OR COMPONENTS SOLD BUT NOT MANUFACTURED BY GRACO.** These items sold, but not manufactured by Graco (such as electric motors, switches, hose, etc.), are subject to the warranty, if any, of their manufacturer. Graco will provide purchaser with reasonable assistance in making any claim for breach of these warranties.

In no event will Graco be liable for indirect, incidental, special or consequential damages resulting from Graco supplying equipment hereunder, or the furnishing, performance, or use of any products or other goods sold hereto, whether due to a breach of contract, breach of warranty, the negligence of Graco, or otherwise.

## FOR GRACO CANADA CUSTOMERS

The Parties acknowledge that they have required that the present document, as well as all documents, notices and legal proceedings entered into, given or instituted pursuant hereto or relating directly or indirectly hereto, be drawn up in English. Les parties reconnaissent avoir convenu que la rédaction du présente document sera en Anglais, ainsi que tous documents, avis et procédures judiciaires exécutés, donnés ou intentés, à la suite de ou en rapport, directement ou indirectement, avec les procédures concernées.

## Graco Information

For the latest information about Graco products, visit [www.graco.com](http://www.graco.com).

**To place an order**, contact your Graco Distributor or call to identify the nearest distributor.

**Phone:** 612-623-6921 **or Toll Free:** 1-800-328-0211 **Fax:** 612-378-3505

All written and visual data contained in this document reflects the latest product information available at the time of publication.

Graco reserves the right to make changes at any time without notice.

For patent information, see [www.graco.com/patents](http://www.graco.com/patents).

Original Instructions. This manual contains English. MM 3A4486

**Graco Headquarters:** Minneapolis

**International Offices:** Belgium, China, Japan, Korea

**GRACO INC. AND SUBSIDIARIES • P.O. BOX 1441 • MINNEAPOLIS MN 55440-1441 • USA**

**Copyright 2016, Graco Inc. All Graco manufacturing locations are registered to ISO 9001.**

[www.graco.com](http://www.graco.com)  
Revision B, January 2018