

GLC 4400 Lubrication Controller

313855M
EN

For controlling and monitoring single-line resistive, parallel, series progressive and dual line, automatic lubrication systems. Not for use in explosive atmospheres!

Part No.: 24B591, Series F: DC Power

Part No.: 24B596, Series F: AC Power



Important Safety Instructions

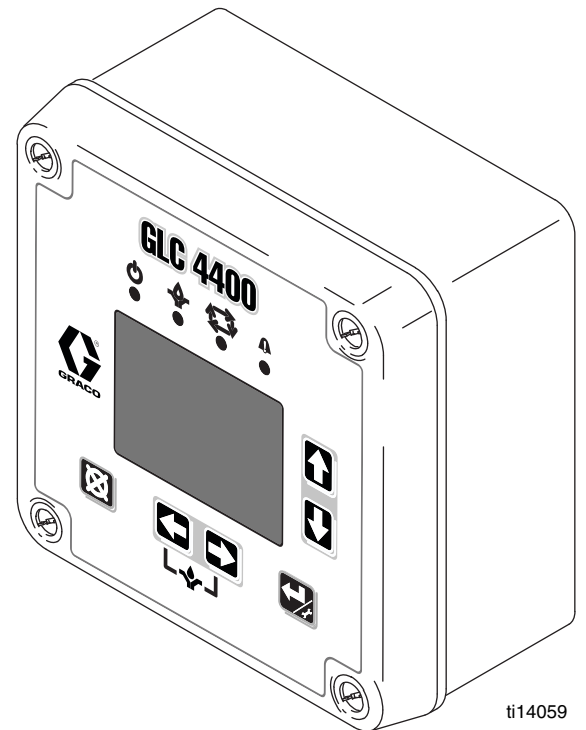

Read all warnings and instructions in this manual. Save these instructions.



ti14059

Warnings

The following warnings are for the setup, use, grounding, maintenance, and repair of this equipment. The exclamation point symbol alerts you to a general warning and the hazard symbol refers to procedure-specific risk. Refer back to these warnings. Additional, product-specific warnings may be found throughout the body of this manual where applicable.

 WARNING	
	<p>ELECTRIC SHOCK HAZARD</p> <p>This equipment must be grounded. Improper grounding, setup, or usage of the system can cause electric shock.</p> <ul style="list-style-type: none"> • Turn off and disconnect power at main switch before disconnecting any cables and before servicing equipment. • Connect only to grounded power source. • All electrical wiring must be done by a qualified electrician and comply with all local and national codes and regulations.
	<p>EQUIPMENT MISUSE HAZARD</p> <p>Misuse can cause death or serious injury.</p> <ul style="list-style-type: none"> • Do not operate the unit when fatigued or under the influence of drugs or alcohol. • Do not exceed the maximum working pressure or temperature rating of the lowest rated system component. See Technical Data in all equipment manuals. • Check equipment daily. Repair or replace worn or damaged parts immediately with genuine manufacturer's replacement parts only. • Do not alter or modify equipment. • Use equipment only for its intended purpose. Call your distributor for information. • Route hoses and cables away from traffic areas, sharp edges, moving parts, and hot surfaces. • Do not kink or over bend hoses or use hoses to pull equipment. • Keep children and animals away from work area. • Comply with all applicable safety regulations.

Component Identification

Keypad, Display, and Icons

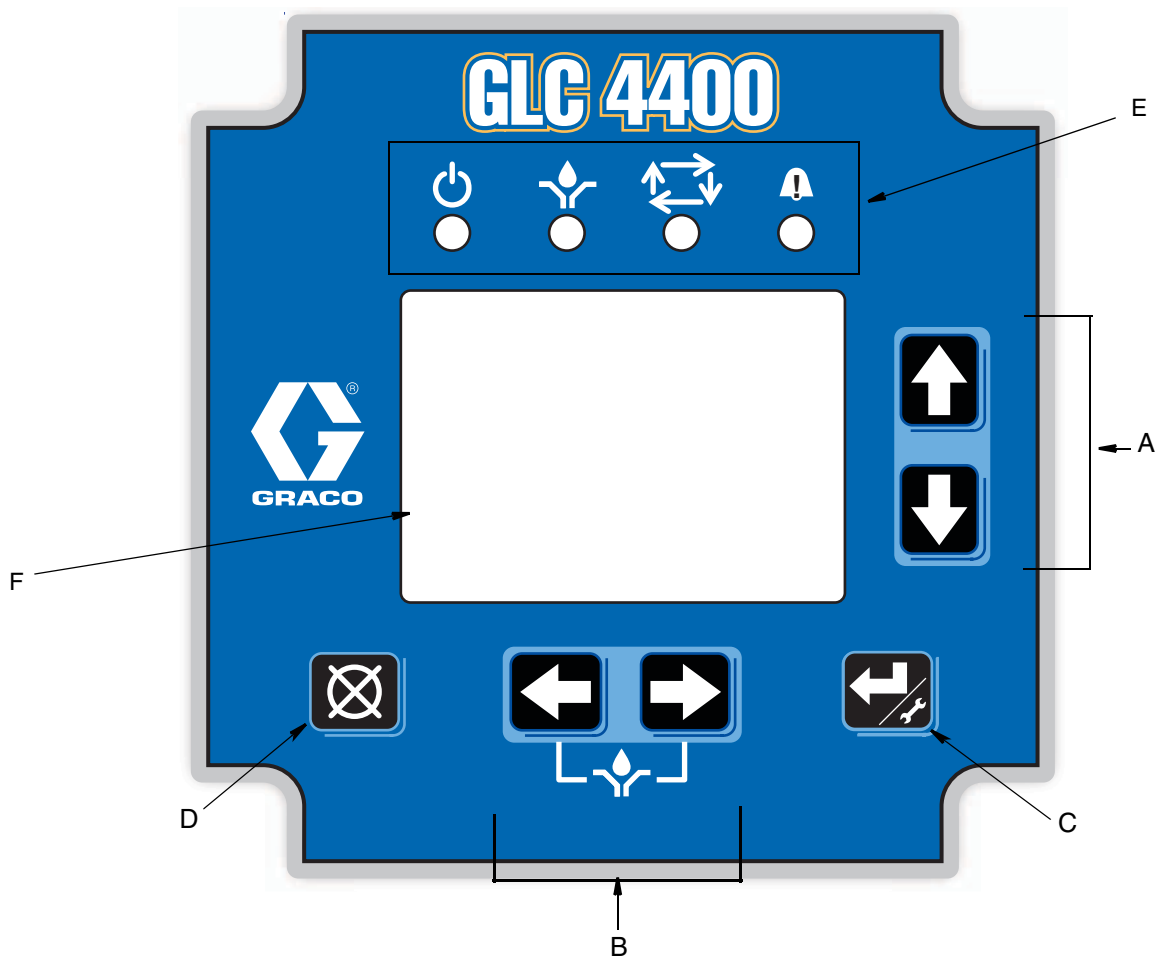

FIG. 1

Run Mode Functions

Direction Arrows

- A Up and Down Arrow Keys: Adjusts contrast.
- B Left and Right Arrow Keys: Adjusts brightness.
- Press the LEFT and RIGHT ARROW keys simultaneously to manually start a pump cycle.





















Keypad Icons

NOTE: Keypad Icons are described on Icon's page 4.

- C ENTER Key: Press and hold for 3 seconds. Allows access to setup.
- D RESET Key: When Pump On is running, press and hold for 3 seconds to go to Pump Off state. During a warning condition, press for 1 second to clear warning. Press and hold for 3 seconds to clear alarm condition. This will reset unit to normal Pump Off State.
- E FUNCTION LED: See page 4 for a description of these icons.
- F DISPLAY

Icon Definitions

The following icons are used throughout this instruction manual and on the Controller's Run and Setup Screens. Refer to this table if you are unsure of an Icon's meaning. (*See Field E, page 3 for location of these Function Icons.)

-  **Power on indicator***. When power is supplied to the Lubrication Controller, Green LED illuminates under Function Icon located above display screen.
-  **Pump On indicator***. When Pump On is running, Yellow LED illuminates under Function Icon located above display screen. Icon also is displayed on top left side of Prelube Run screens (see page 40).
-  **Pump Off indicator**. When Pump Off is running, icon is displayed on top left side of Run screens (see page 41).
-  **Alarm event activated**. LED illuminates when an Alarm event occurs. Icon also displays on top right side of Alarm screen (see page 43).
-  **Brightness adjustment**. Use the LEFT/RIGHT Arrow key to adjust display backlight (brighter or darker) (see page 20).
-  **Contrast adjustment**. Use the UP/DOWN Arrow key to adjust screen contrast (see page 20).
-  **Low Level Alarm**. Icon appears on display screen. Indicates the lubrication fluid level is low.
-  **Change Icon**. When icon appears on PIN setup screen, indicates changes can be made to PIN number or new PIN number can be added.
-  **Lock Icon**. Indicates the Setup screens are password protected and require the user to provide the correct PIN number to access this feature.
-  **Setup mode active**. When user is on the Main Setup Screen in the Setup Mode, icon displays on the upper right corner of the display screen.
-  **Timer mode activated**. Displays on right side of screen when a Timer Setup or Run screen is displayed (pages 24, 27, 40 and 41).
-  **Pressure mode activated**. Icon displays on right side screen when a Pressure Setup or Run screen is displayed (page 25 and 40).
-  **Pressure mode error**. Icon displays on the alarm screen to signal the allotted time ran out before the pressure switch was tripped.
-  **High pressure error**. Icon appears on the display screen. Indicates that the high pressure switch was tripped (Series F and later).
-  **Cycle count mode active***. Yellow LED illuminates under Function Icon located above display screen. Icon also appears on right side of display screen when a Cycle Setup or Run screen is displayed (page 25 and 41).
-  **Machine count active**. Displays on right side of Setup or Run screen when a Machine Count screen is displayed (page 27 and 42).
-  **Machine count error**. When icon displays on alarm screen, indicates the set number of machine counts was not received before time expired (page 42). This would trigger an alarm event.
-  **Cycle switch input error**. Icon displays in center of Alarm screen to indicate the allotted time ran out before the programmed number of cycle switch activations was received (see Alarm Screen, page 43).
-  **Alarm***. Red LED illuminates under symbol located above display screen. Icon also appears on display when no valid run values have been entered.
-  **Solenoid error**. Icon appears on display screen. Indicates that the solenoid is still on when the Pump OFF mode occurs (Series F and later).

Installation

Typical Installation

The installation shown in FIG. 2 is only a guide for selecting and installing system components. Contact your Graco distributor for assistance in planning a system to suit your needs.

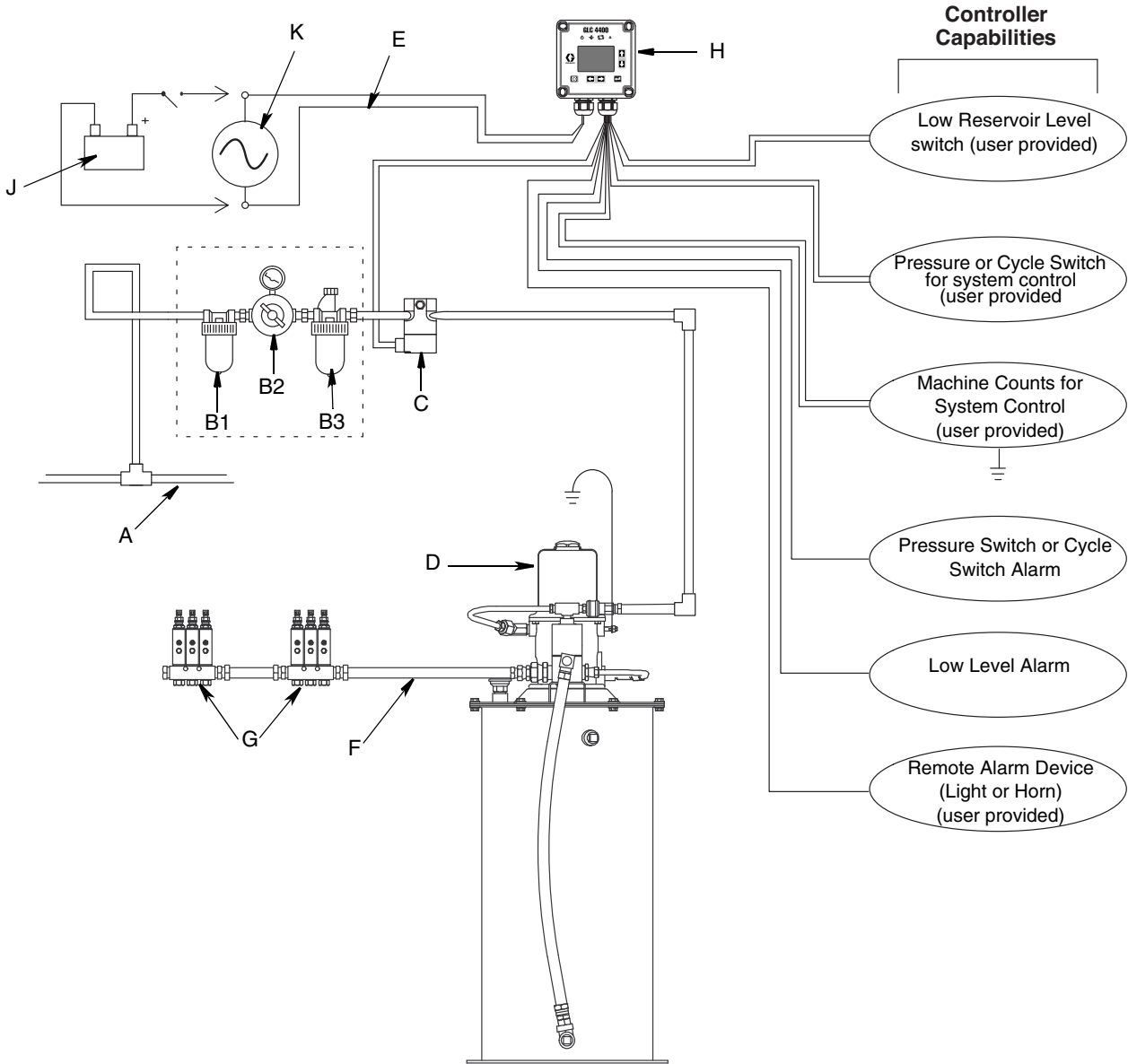

FIG. 2

- | | |
|--|---|
| <p>A Main Air Supply
 B Filter/Regulator/Lubricator Assembly
 B1 - Filter
 B2 - Regulator
 B3 - Lubricator
 C Air Solenoid Valve
 D Pump Module
 E Ignition Switch
 F High-Pressure Lubricant Supply Lines</p> | <p>G Injector Banks
 H Lubrication Controller
 J Model 24B591 12/24VDC Power Supply
 K Model 24B596 115/230VAC Power Supply</p> |
|--|---|

Installing the Lubrication Controller

AUTOMATIC SYSTEM ACTIVATION HAZARD						
Unexpected activation of the system could result in serious injury, including skin injection and amputation.						
This device has an automatic timer that activates the pump lubrication system when power is connected or when exiting the programming function. Before you install or remove the Lubrication Controller from the system, disconnect and isolate all power supplies and relieve all pressure.						

1. Select a flat surface to install the Lubrication Controller. Drill mounting holes. Refer to Mounting Hole Layout provided in the Technical Data section of this manual, page 46.

NOTICE
Pre-drill and use designated mounting holes in Lubrication Controller box only. Failure to use designated mounting holes can cause circuit board damage.

2. Remove Lubrication Controller cover and align junction box with predrilled holes (FIG. 3, (a)). Use four,

Grounding

--	--	--	--	--	--	--

The equipment must be grounded. Grounding reduces the risk of static and electric shock by providing an escape wire for the electrical current due to static build up or in the event of a short circuit.

1. Loosen M6 screws from (b).
2. Attach up to 3 ground wires to (b) using appropriate sized M6 ring terminal (not provided).
3. If more than 3 wires are used, attach necessary amount of jumpers to other adjacent screw terminals.

#6 screws (not provided) to secure junction box to mounting surface.

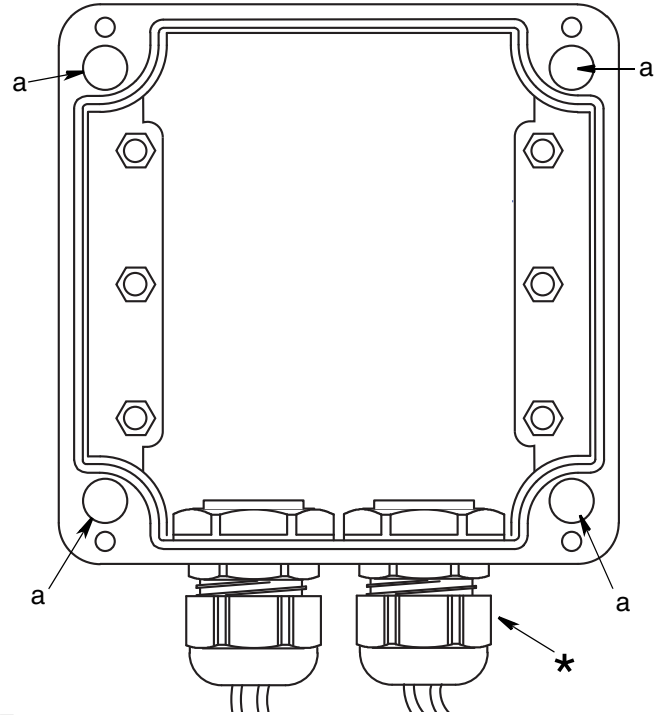

FIG. 3

* Parts not supplied. To maintain IP69K rating, proper connectors must be used.

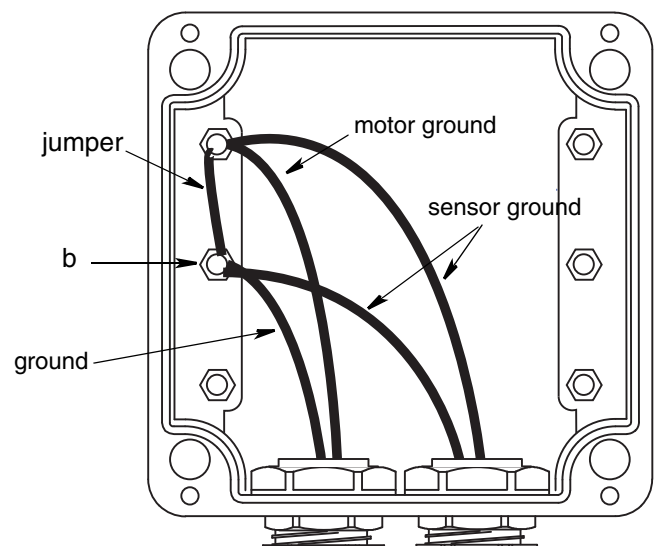
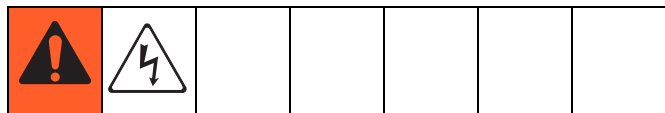

FIG. 4

System Configuration and Wiring



The System Configuration Diagrams (FIG. 5 - FIG. 7), Sensor Wiring Diagrams (FIG. 8 - FIG. 10) and Wiring Diagrams (FIG. 11 - FIG. 16) on the following pages, show typical Injector, Divider Valve and Dual Line lubrication system configurations.

Refer to Table 1, 2 and 3 to determine the Required System Configuration, Sensor Configuration and Wiring Diagram to use to setup your system.

Table 4 shows additional (optional) setup configurations (FIG. 17 - FIG. 19).

Table 1: System Configurations

System	Figure	Page
Divider Valve	5	8
Dual Line	6	9
Injector	7	10

Table 2: Sensor Wiring Configurations

Sensor	Figure	Page
Dry Contact	8	11
Sourcing	9	11
Sinking	10	11

Table 3: Modes of Operation

Mode	Power	Figure	Page
Time ON/Time OFF	DC	11	12
Time ON/Time OFF	AC	12	12
Cycle ON or Pressure ON/Time OFF	DC	13	13
Cycle ON or Pressure ON/Time OFF	AC	14	13
Cycle ON or Pressure ON/Machine Count OFF	DC	15	14
Cycle ON or Pressure ON/Machine Count OFF	AC	16	14

Table 4: Optional I/O Wiring Diagrams

System Mode	Power Supply Wiring Diagram
Low Level Switch	FIG. 17, page 15
External Manual Run	FIG. 17, page 15
O.K. Contact Out	FIG. 17, page 15
Auxiliary and Low Level Alarm Out	DC: FIG. 18, page 16 115/230 VAC: FIG. 19, page 16

System Configuration

Divider Valve System

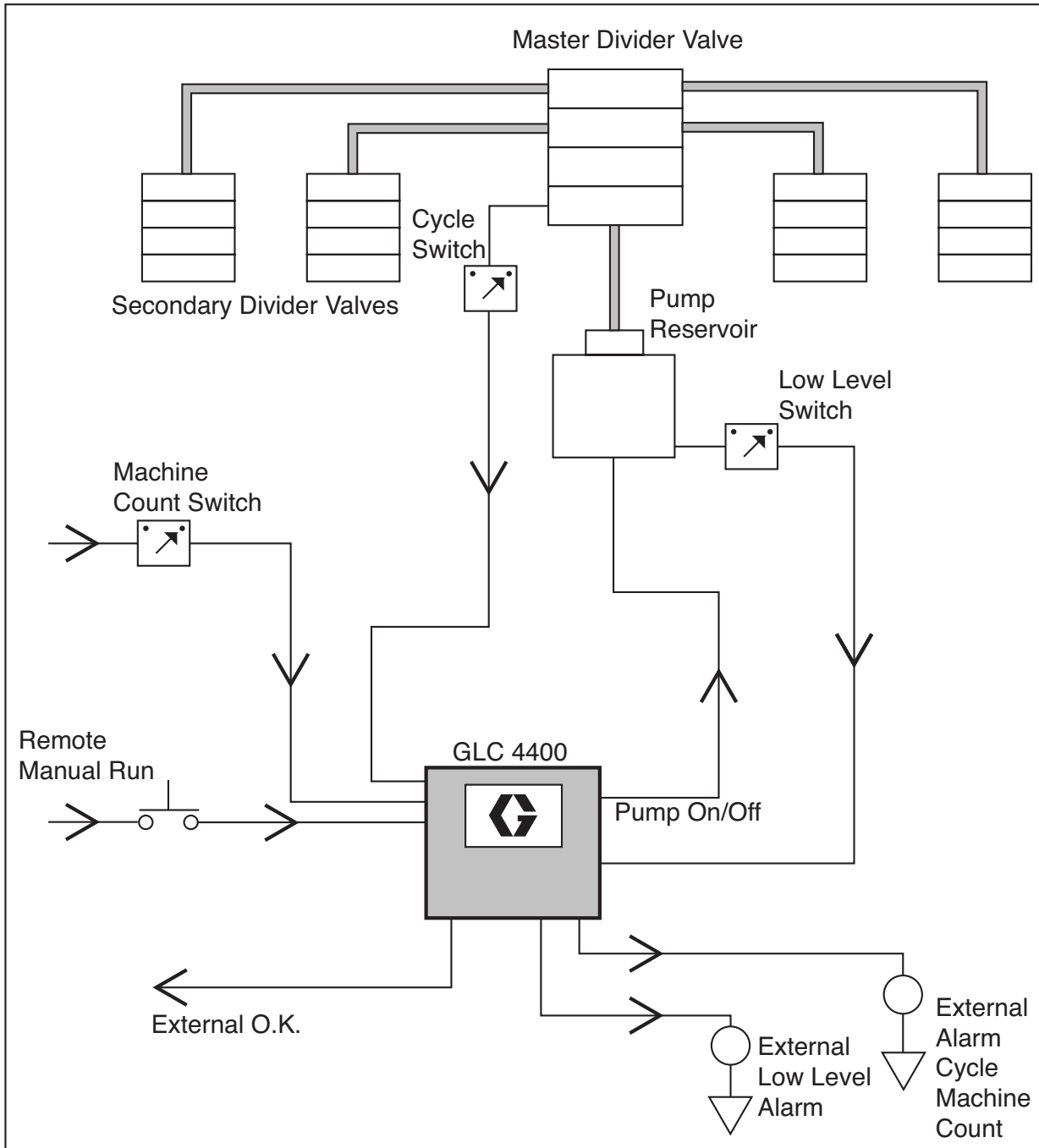

FIG. 5

Dual Line System

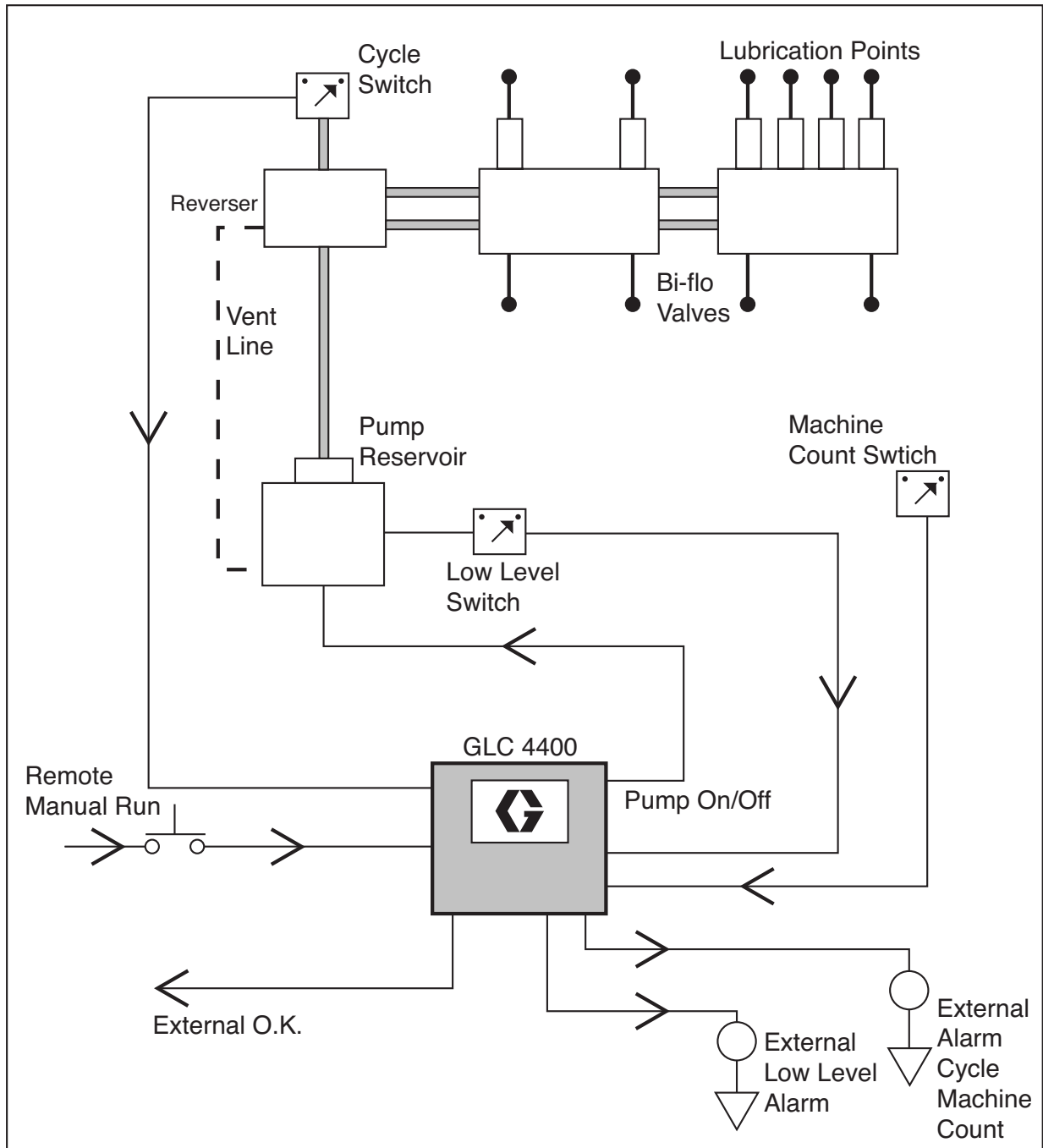

FIG. 6

Injector System

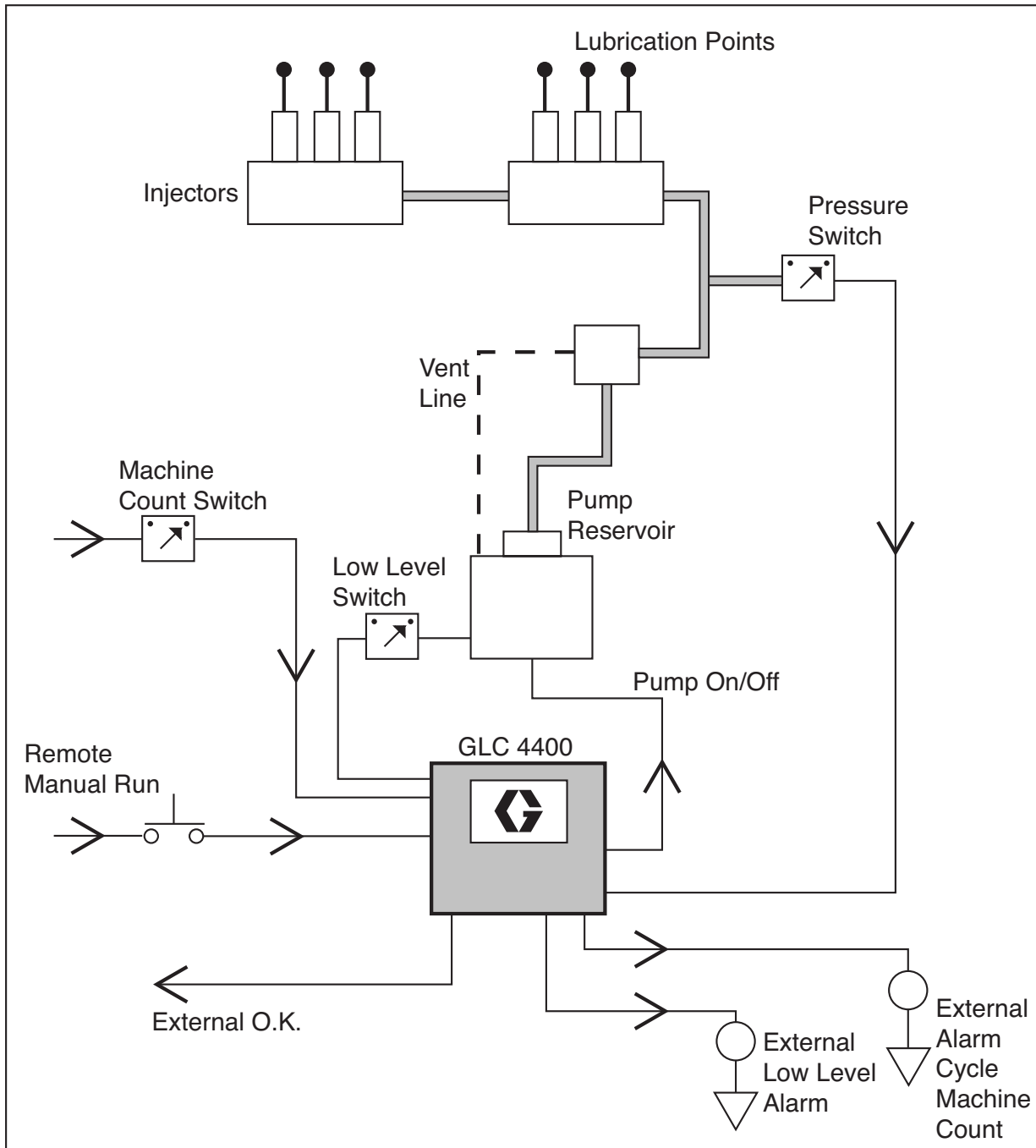

FIG. 7

System Wiring

NOTICE

Do not connect any of the SW+ (13,9,5,1) and SW- (16,12,8,4) pins together, either directly or via a switch closure. Doing so will create a short circuit condition which will disable and potentially damage the controller.

NOTE:

- On an AC controller (p/n 24B596), the J7 strip is line (input) voltage but the J6 strip is all 24VDC. On a DC controller (p/n 24B591), the J6 and J7 terminals all carry the input voltage.
- SEN (x) jumper must be field installed.

Input Sensor Wiring:

DRY CONTACT SWITCH

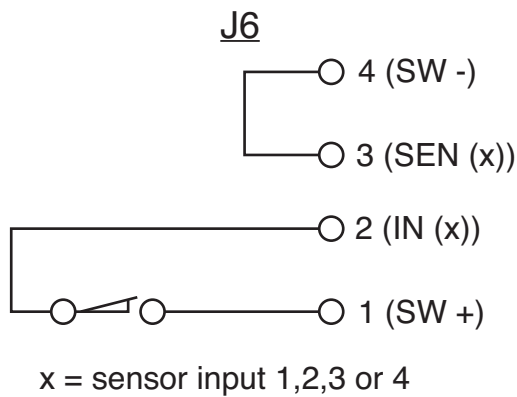

FIG. 8

SINK SWITCH (NPN) - 2 or 3 Wire Type

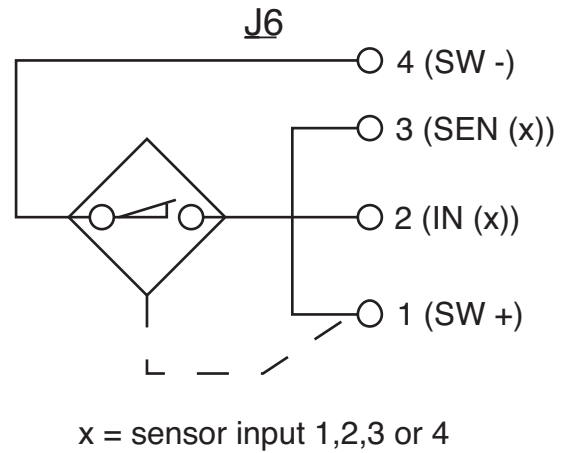

FIG. 10

SOURCE SWITCH (PNP) - 2 or 3 Wire Type

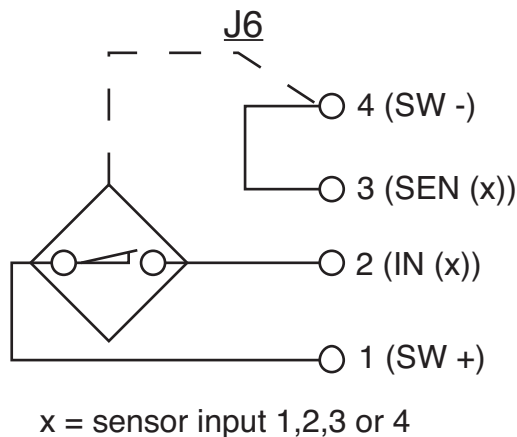

FIG. 9

Pump ON = Time; Pump OFF = Time

9 - 30VDC

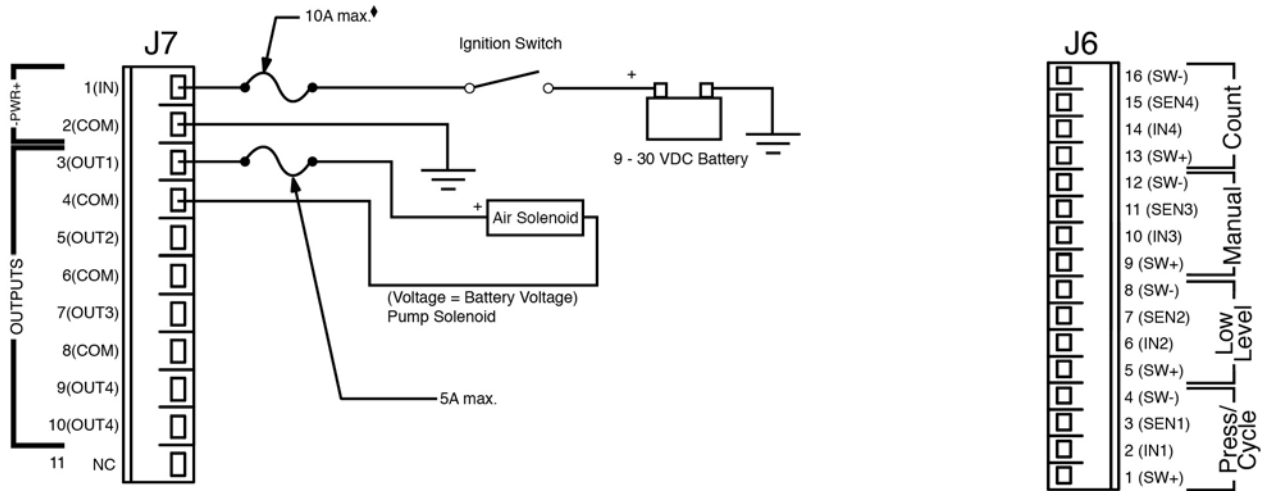

FIG. 11: ♦ Total output current should not exceed input rating.

100VAC/240VAC

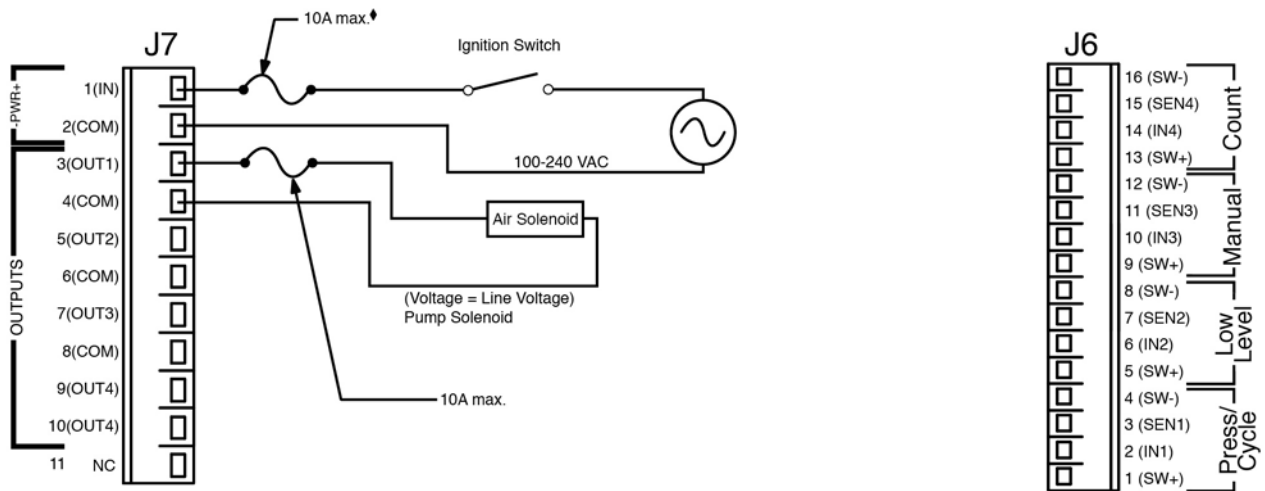

FIG. 12: ♦ Total output current should not exceed input rating.

System Wiring

Pump ON = Cycle or Pressure; Pump OFF = Time

9 - 30VDC

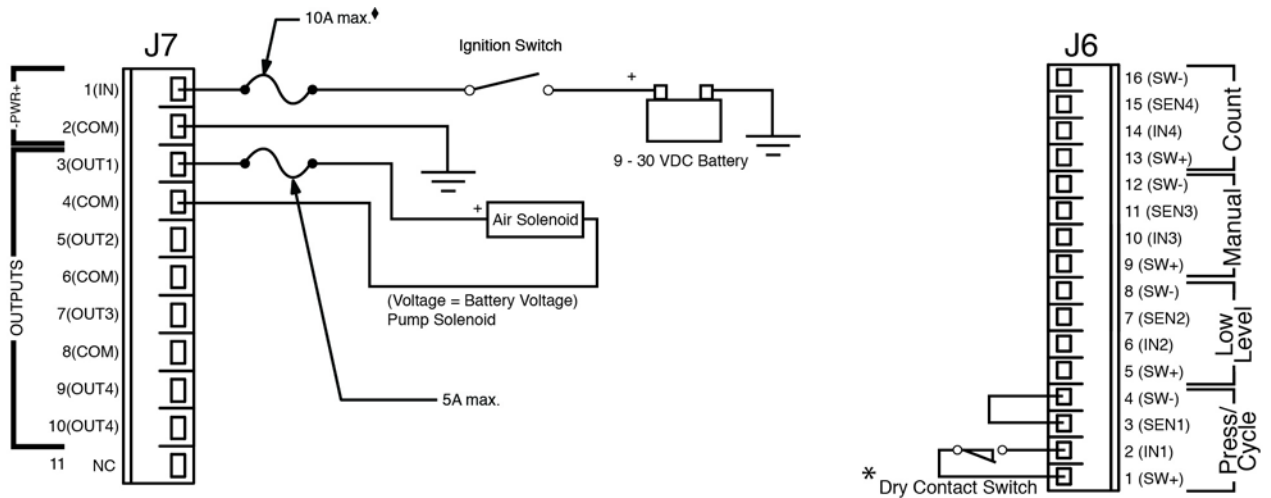

FIG. 13: *Dry Contact, FIG. 8 shown. For other configuration, see FIG. 9 or FIG. 10.
 ◆Total output current should not exceed input rating.

100VAC/240VAC

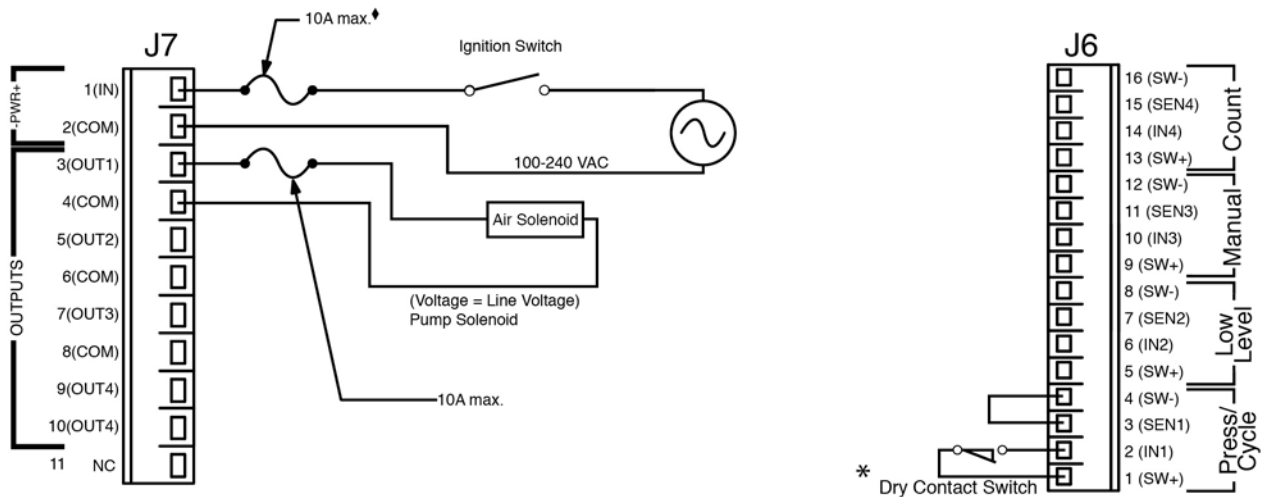

FIG. 14: *Dry Contact, FIG. 8 shown. For other configuration, see FIG. 9 or FIG. 10.
 ◆Total output current should not exceed input rating.

System Wiring

Pump ON = Cycle or Pressure; Pump OFF = Machine Count

9 - 30VDC

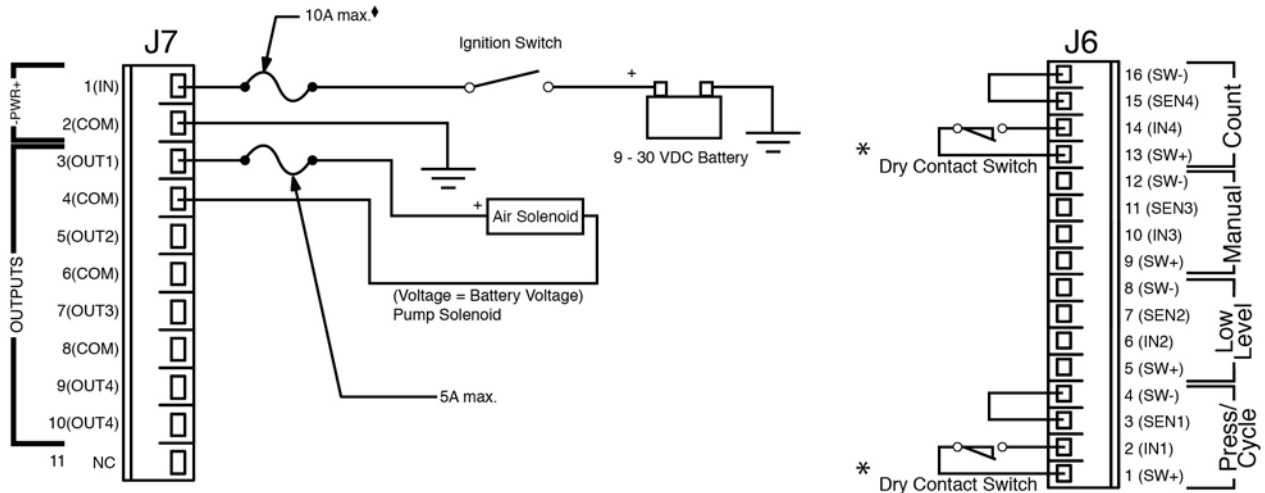

FIG. 15: Dry Contact, FIG. 8 shown. For other configuration, see FIG. 9 or FIG. 10.
 ◆Total output current should not exceed input rating.

100VAC/240VAC

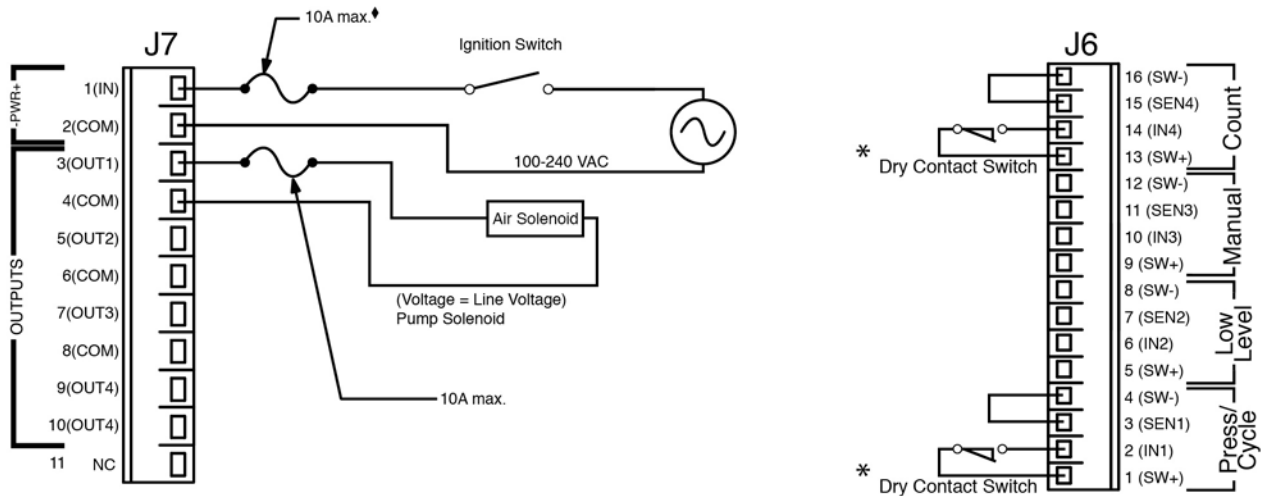

FIG. 16: *Dry Contact, FIG. 8 shown. For other configuration, see FIG. 9 or FIG. 10.
 ◆Total output current should not exceed input rating.

System Wiring Options

NOTICE

Do not connect any of the SW+ (13,9,5,1) and SW- (16,12,8,4) pins together, either directly or via a switch closure. Doing so will create a short circuit condition which will disable and potentially damage the controller.

All Units: Low Level Switch / External Manual Run or High Pressure Switch / O.K. Contact Out

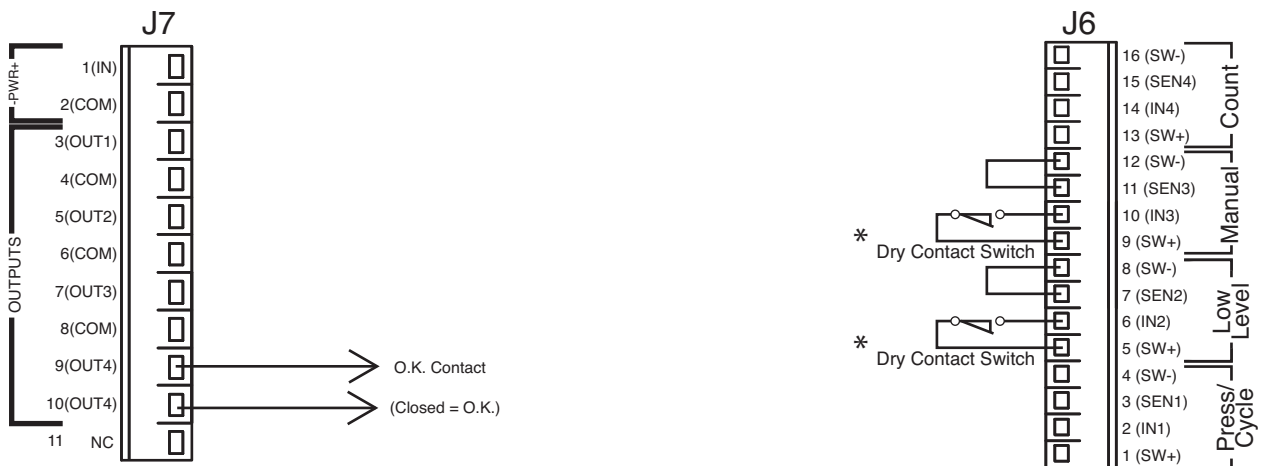

FIG. 17: *Dry Contact, FIG. 8 shown. For other configuration, see FIG. 9 or FIG. 10.

System Wiring Options: Alarm Out / High Pressure Switch into Dig in \$

9 - 30VDC

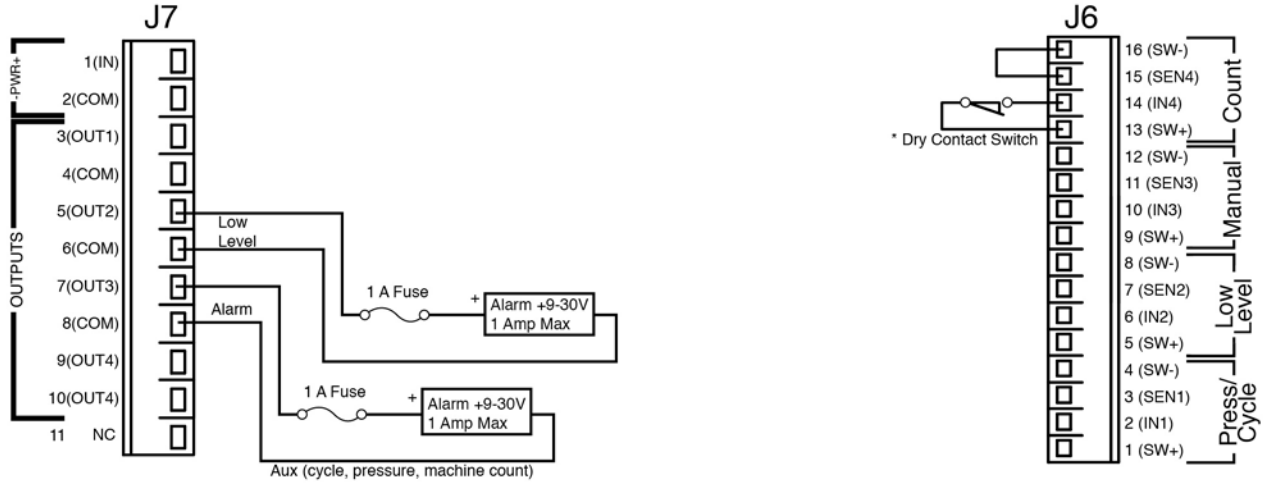

FIG. 18: *Dry Contact, FIG. 8 shown. For other configuration, see FIG. 9 or FIG. 10.

100/240VAC

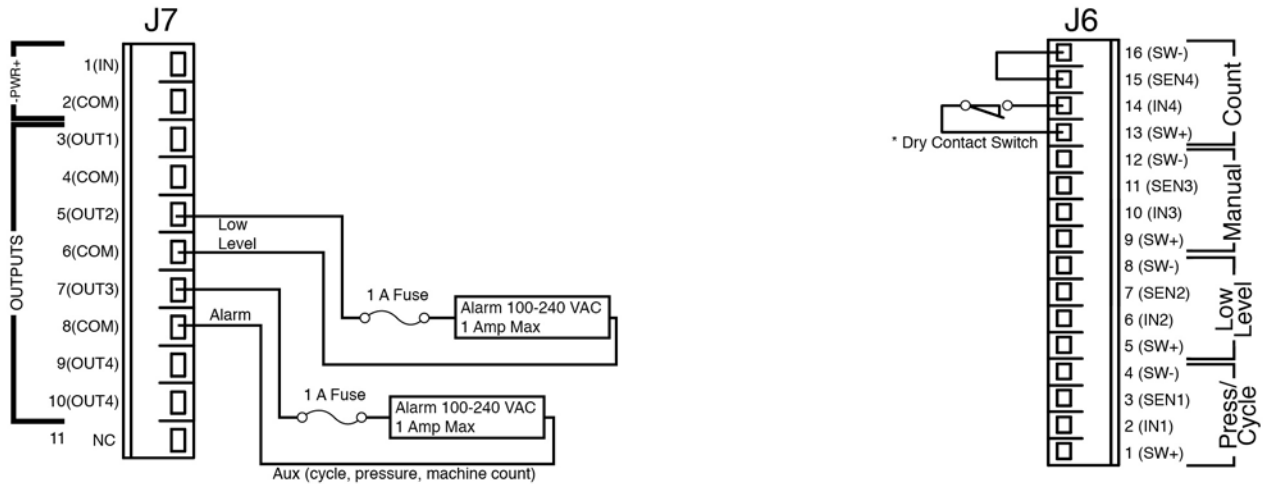
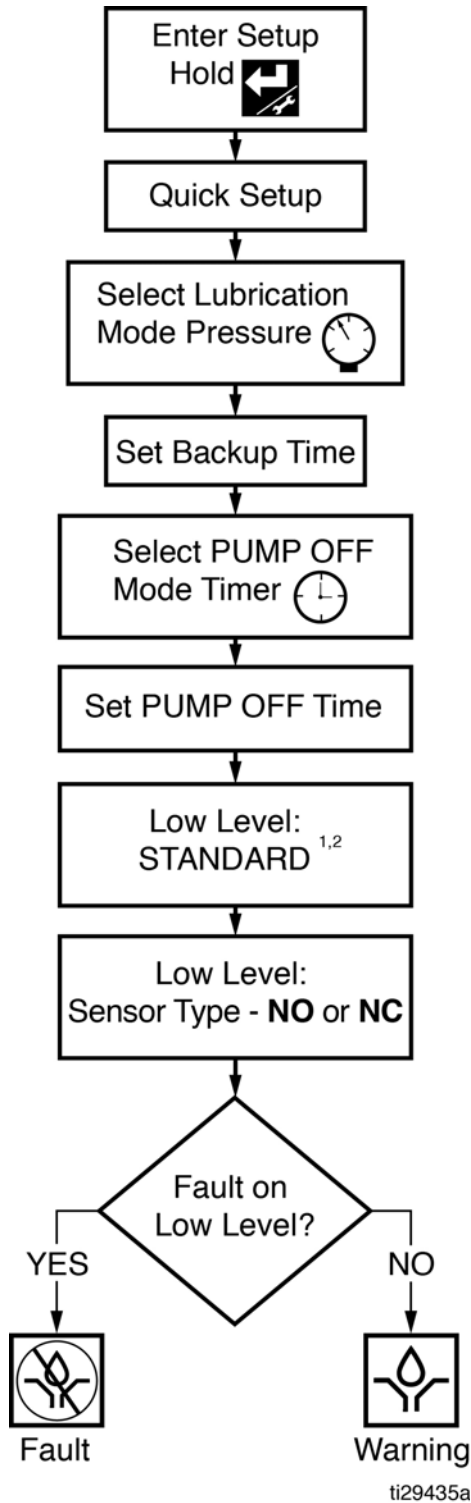

FIG. 19: *Dry Contact, FIG. 8 shown. For other configuration, see FIG. 9 or FIG. 10.

Application Programming Instructions

GLC4400 Single Line Parallel Programming



Wiring Information

Signal	J? +, -
Power	J7 1, 2
Pump	J7 3, 4
LL Alarm	J7 5, 6 (opt)
Aux Alarm	J7 7, 8 (opt)

Signal	J? Pin#
Pressure Switch	J6 2
Low Level	J6 6 (opt)
Remote Run	J6 10 (opt)
Machine Count ³	J6 14 (opt)

Advanced Settings to Consider

Prelube?	ADVANCED -> POWER UP
Lubrication Delay at Startup?	ADVANCED -> POWER UP
Reciprocate Pump?	ADVANCED -> PULSED
Solenoid Failure Indication? (Must have cycle feedback, Series F and later)	ADVANCED->SOLENOID ERR
High Pressure Indication? (Series F and later)	ADVANCED->HIGH PRESS
Relay Customization? (Series F and later)	ADVANCED>RELAY SETUP
Recommended	ADVANCED-> PIN CODE

Notes:

1. If Low Level is not connected, select SKIP.
2. If G3 Pump, select PADDLE.
3. See programming instructions sections of manual for machine count programming information.

GLC4400 Series Progressive Programming

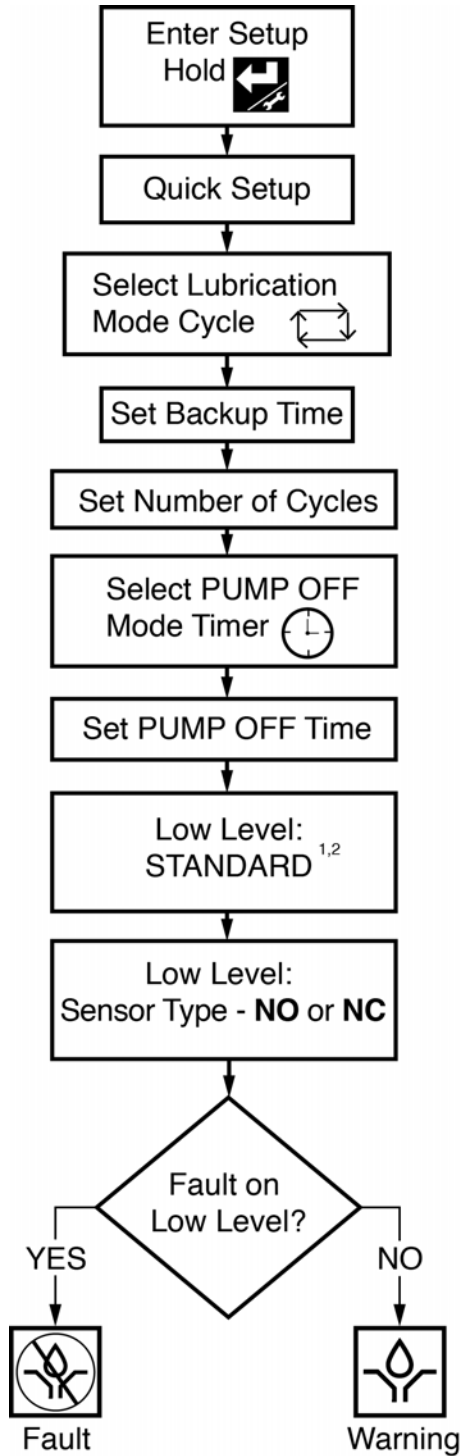

ti29436a

Wiring Information

Signal	J? +, -
Power	J7 1, 2
Pump	J7 3, 4
LL Alarm	J7 5, 6 (opt)
Aux Alarm	J7 7, 8 (opt)

Signal	J? Pin#
Pressure Switch	J6 2
Low Level	J6 6 (opt)
Remote Run	J6 10 (opt)
Machine Count ³	J6 14 (opt)

Advanced Settings to Consider

Prelube?	ADVANCED -> POWER UP
Lubrication Delay at Startup?	ADVANCED -> POWER UP
Reciprocate Pump?	ADVANCED -> PULSED
Solenoid Failure Indication? (Must have cycle feedback, Series F and later)	ADVANCED->SOLENOID ERR
High Pressure Indication? (Series F and later)	ADVANCED->HIGH PRESS
Relay Customization? (Series F and later)	ADVANCED>RELAY SETUP
Recommended	ADVANCED-> PIN CODE

Notes:

1. If Low Level is not connected, select SKIP.
2. If G3 Pump, select PADDLE.
3. See programming instructions sections of manual for machine count programming information.

GLC4400 Time-Based Programming

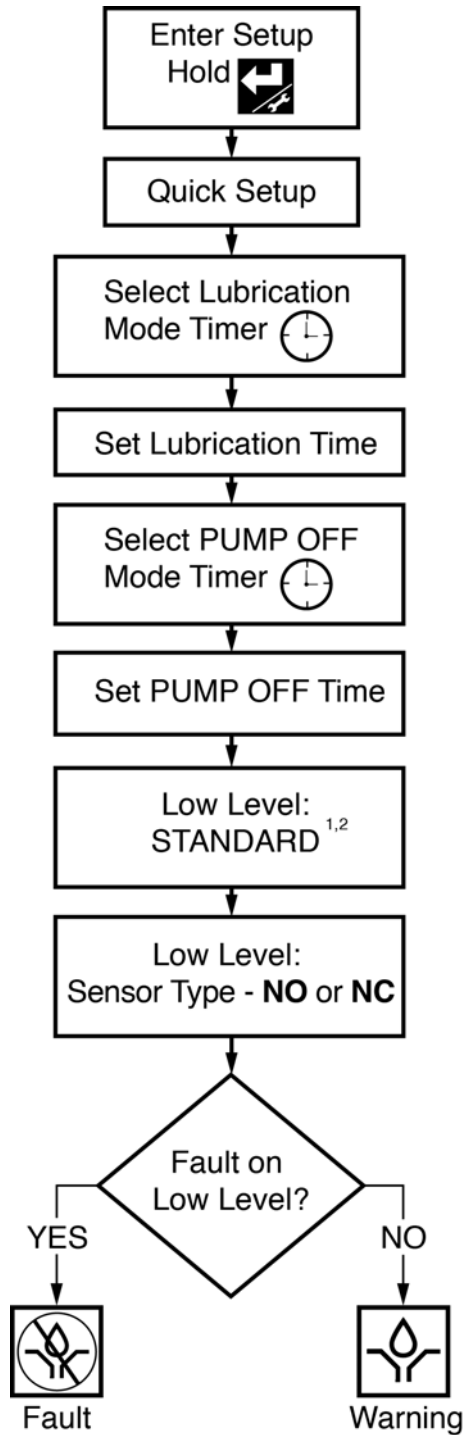

ti29437a

Wiring Information

Signal	J? +, -
Power	J7 1, 2
Pump	J7 3, 4
LL Alarm	J7 5, 6 (opt)
Aux Alarm	J7 7, 8 (opt)

Signal	J? Pin#
Pressure Switch	J6 2
Low Level	J6 6 (opt)
Remote Run	J6 10 (opt)
Machine Count ³	J6 14 (opt)

Advanced Settings to Consider

Prelube?	ADVANCED -> POWER UP
Lubrication Delay at Startup?	ADVANCED -> POWER UP
Reciprocate Pump?	ADVANCED -> PULSED
Solenoid Failure Indication? (Must have cycle feedback, Series F and later)	ADVANCED->SOLENOID ERR
High Pressure Indication? (Series F and later)	ADVANCED->HIGH PRESS
Relay Customization? (Series F and later)	ADVANCED>RELAY SETUP
Recommended	ADVANCED-> PIN CODE

Notes:

1. If Low Level is not connected, select SKIP.
2. If G3 Pump, select PADDLE.
3. See programming instructions sections of manual for machine count programming information.

Setup

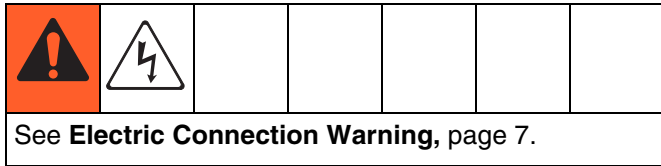

When you first turn on power to the Lubrication Controller, the following identification screen displays.

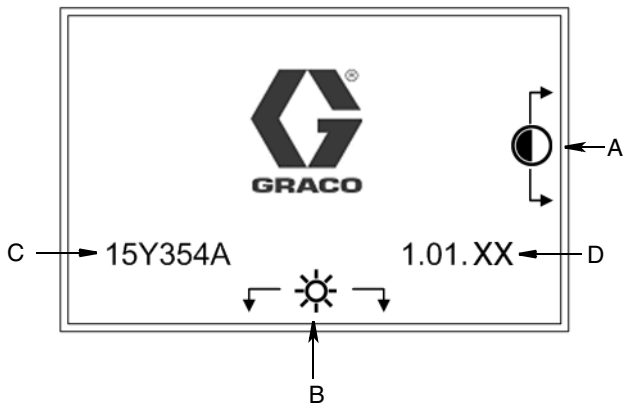

FIG. 20

- A **Display Contrast Adjustment:** UP and DOWN Arrows can be used to adjust the display contrast.
 - B **Brightness Adjustment:** LEFT and RIGHT Arrows can be used to adjust the backlight brightness.
- NOTE:** Contrast and Brightness adjustments can be made on any Run Screen at any time.
- C **Software (Part Number):** 15Y354
 - D **(Software) Version:** 1.01.XX

NOTE: The example of the Software Version (D) shown in FIG. 20 displays “XX” as the last two numerals. On your Controller’s screen, the “XX” will be replaced by the current software version numbers.

PIN Mode Enabled

1. To access Setup Mode, hold down the ENTER key for 3 seconds. The PIN ModeScreen shown in FIG. 21 displays.

NOTE:

- The Pin Mode screen shown in FIG. 21 only displays when the PIN mode is enabled. For setting up systems when the PIN mode is not enabled, go to System Setup instructions on page 21.
- Before the PIN Mode screen shown in FIG. 21 can display, the PIN Mode must be enabled in an previous setup sequence. See PIN Setup, page 32.

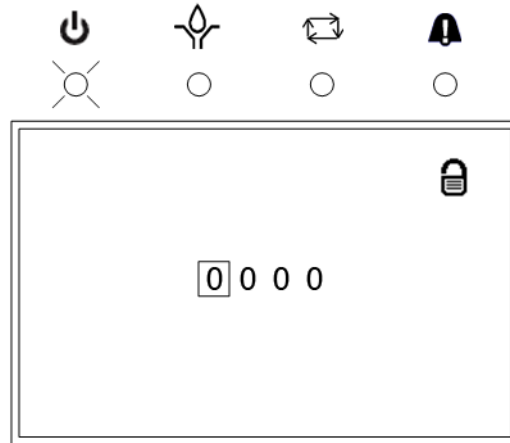

FIG. 21

2. The PIN Mode screen in FIG. 21 displays.

NOTE: The PIN Code prompt spaces are initially blank.

3. Use the LEFT / RIGHT arrow to position the cursor over the first blank PIN Code prompt field (FIG. 21).
4. Use the UP/DOWN arrows to move up and down through the numbers 0-9 until the first number in the PIN code is displayed in the field.
5. Use the RIGHT arrow to move the cursor to the next field.
6. Repeat steps 4 and 5 for each PIN Code prompt field.
7. When finished, press ENTER.

8. If the PIN Code you entered is correct, the System Setup Screen, shown in FIG. 23 displays.
9. If the PIN Code you entered is incorrect, the digits flash. The Code must be re-entered by repeating steps 4 and 5.

NOTE:

- As soon as any arrow key is pressed, the numerals stop flashing.
- To leave any Setup Screen and return to normal operation, press RESET.

System Setup

NOTE: For Series D or earlier models, proceed to Advanced System Setup, page 24. Advanced System Setup is the original setup methodology.

Setup Instructions - Series E

Use the UP/Down Arrow keys to select between Quick System Setup and Advanced System Setup as shown in FIG. 22.

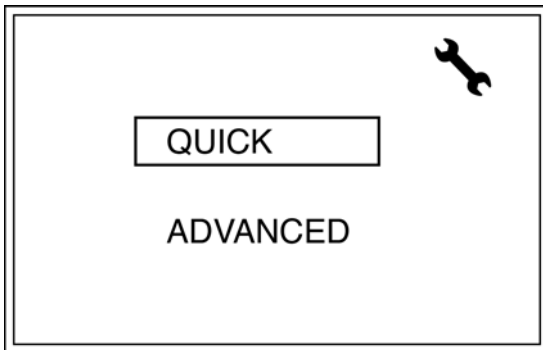
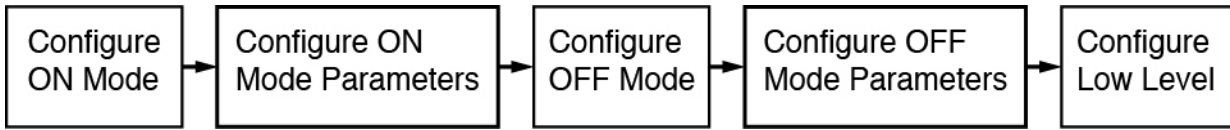

FIG. 22

Quick System Setup



PUMP ON



Defines when a lubrication event ends.

PUMP OFF



Defines when a lubrication event begins.

Low Level



Defines behavior of low level input. Typically used to signal controller when the lubrication level in the tank is low.

Pressing CANCEL at any point will move to the previous subsection or the beginning of the previous section of the Quick System Setup.

Holding CANCEL for 3 second will abort the system setup.

1. PUMP ON Mode



Use arrows to select mode icon, then press ENTER.

a. Timer



Enter ON Time in HH:MM:SS by using the LEFT/RIGHT arrows to select digit and use the UP/DOWN arrows to change time.

b. Pressure



Enter ON Timeout in HH:MM:SS buy using the LEFT/RIGHT arrows to select digit and use the UP/DOWN arrows to change time. If pressure is not reached within this timeout the controller will enter a fault state.

c. Cycles











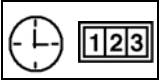

Defines the number of cycles needed to finish a lubrication cycle.

i.

Enter ON Timeout in HH:MM:SS by using the LEFT/RIGHT arrows to select digit and use the UP/DOWN arrows to change value. If cycle count is not reached within this timeout, the controller will enter a fault state.

ii.

Enter Cycle Count by using LEFT/RIGHT arrow to select digit and use UP/DOWN arrows to change time.

2. **PUMP OFF Mode**  Use arrows to select mode icon (user can select both icons)
- a. **Timer**  Enter OFF/WAIT Time in HH:MM:SS (Series E and earlier) or HHHH:MM:SS (Series F and later) by using the LEFT/RIGHT arrows to select digit and use the UP/DOWN arrows to change value. Sets time between lubrication events.
- b. **Machine Counts**  Enter number of machine counts between lubrication cycles by using the LEFT/RIGHT arrows to select the digit and the UP/DOWN arrows to change value.
- c. **Timer and Machine Counts** 
- i. Enter OFF/WAIT Time in HH:MM:SS (Series E and earlier) or HHHH:MM:SS (Series F and later) by using the LEFT/RIGHT arrows to select digit and use the UP/DOWN arrows to change value. Sets time between lubrication events.
- ii. Enter number of machine counts between lubrication cycles by using LEFT/RIGHT arrows to select the digit and UP/DOWN arrows to change value.
- iii. **NOTE:** Timeout behavior is only selectable through ADVANCED SYSTEM SETUP, page 24. Default behavior is to enter a fault on timeout.
3. **Low Level** 
- a. **Skip** Makes no change to existing low level settings.
- b. **Standard** Sets controller to provide low level fault from a point level switch.
- i.  Select Sensor Type
-  Normally Open (NO)
 -  Normally Closed (NC)
- ii.  Select Fault or Warning Behavior
- **Pump OFF**  Configures the controller to enter a fault when a low level signal occurs.
 - **Pump ON**  Configures the controller to provide low level Warnings. When the signal is present, the system will continue to run.
- c. **Paddle** Sets the controller to provide low level fault based on G3 Defaults (10 signals).

NOTE: Icon definitions are provided on page 4.

NOTE: For proper setup ensure that the low level signal is deactivated during setup (no low level condition).

Advanced System Setup

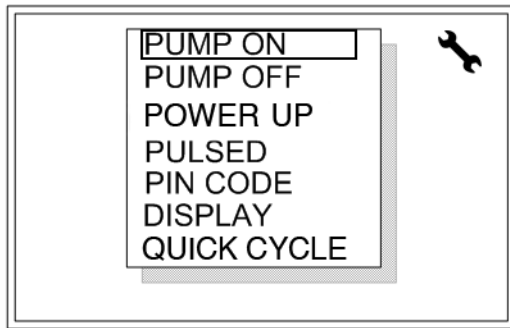

FIG. 23

1. Use the UP/DOWN arrows to move the cursor up and down through the list of setup screens (FIG. 23).
2. Press ENTER to display the selected setup screen.
3. When all setup operations are complete, press RESET to return to normal operation.

PUMP ON Setup

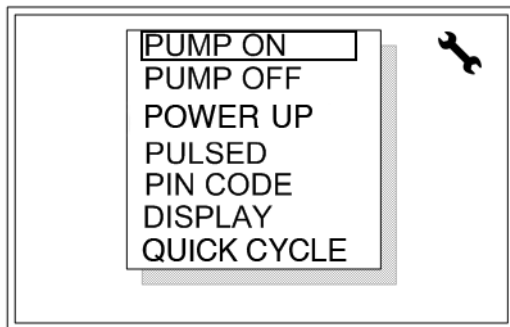

FIG. 24

Pump On is the length of time the pump runs before its cycle is terminated by either a timer, a specific number of cycles or a certain pressure threshold is attained.

1. Use the UP/DOWN Arrow keys to move the cursor over PUMP ON.
2. Press ENTER to display the PUMP ON setup screen.

TIMER Setup

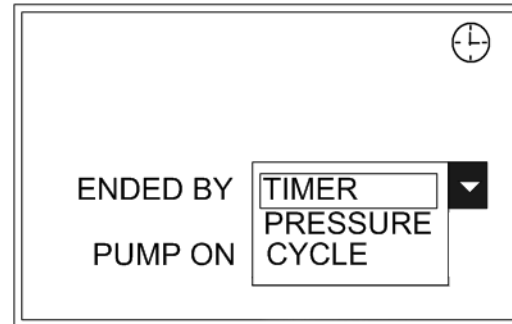
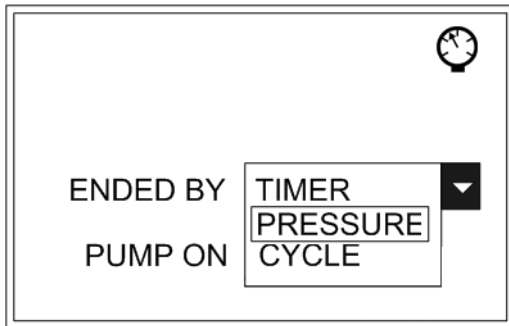

FIG. 25

NOTE: Time is displayed in HH:MM:SS.

1. Use the Arrow keys to move the cursor over the PUMP ON time box.
2. Press ENTER.
3. Use the UP/DOWN arrows to move up and down through the numbers 0-9 until the first number in the PUMP ON time is displayed in the field.
4. Use the RIGHT arrow to move the cursor to the next field.
5. Repeat steps 3 and 4 until the desired time is displayed.
6. Use the Arrow keys to move the cursor over the ENDED BY pull-down list.
7. Press ENTER.
8. Select TIMER from the pull-down list.
9. Press RESET. The Main Screen displays.

NOTE: When TIMER is selected, the Timer Icon will display on the top right corner of the screen.

PRESSURE Setup**FIG. 26**

NOTE: Time is displayed in HH:MM:SS.

1. Use the Arrow keys to move the cursor over the PUMP ON time box.
2. Press ENTER.
3. Use the UP/DOWN arrows to move up and down through the numbers 0-9 until the first number in the PUMP ON time is displayed in the field.
4. Use the RIGHT arrow to move the cursor to the next field.
5. Repeat steps 3 and 4 until the desired time is displayed.
6. Use the Arrow keys to move the cursor over the ENDED BY pull-down list.
7. Press ENTER.
8. Select PRESSURE from the pull-down list.
9. Press RESET. The Main Screen, page 24 displays.

NOTE: When PRESSURE is selected, the Pressure Icon will display on the top right corner of the screen.

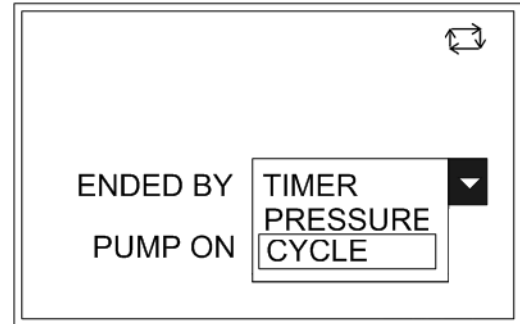
CYCLE END Setup**FIG. 27**

NOTE: Time is displayed in HH:MM:SS.

1. Use the Arrow keys to move the cursor over the PUMP ON time box.
2. Press ENTER.
3. Use the UP/DOWN arrows to move up and down through the numbers 0-9 until the first number in the PUMP ON time is displayed in the field.
4. Use the RIGHT arrow to move the cursor to the next field.
5. Repeat steps 3 and 4 until the desired time is displayed.
6. Use the Arrow keys to move the cursor over the ENDED BY pull-down list.
7. Press ENTER.
8. Select CYCLE from the pull-down list.
9. Press ENTER.

Cycle Mode Selection

If the Cycle Mode is selected you will also be prompted to set the desired number of cycles.

NOTE: A cycle is equal to two switch closure transitions at the cycle switch input.

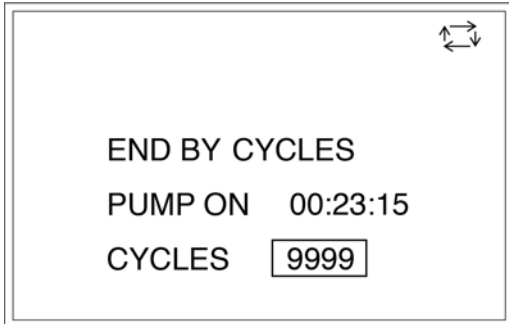

FIG. 28

10. Use the Arrow keys to move the cursor over the CYCLES field.
11. Press ENTER.
12. Use the UP/DOWN arrows to move up and down through the numbers 0-9 until the first number you want in the CYCLES field is displayed.
13. Use the RIGHT arrow to move the cursor to the next field. Repeat step 12.

NOTE: The maximum number of Cycles you can setup in this field is 99 (Series E and earlier) or 9999 (Series F and later).

14. Press RESET. The Main Screen, page 24 displays.

NOTE: When Cycles is selected, the Cycles Icon displays in the upper right corner of the screen.

PUMP OFF Setup

Sets up how the PUMP OFF cycle is ended: Time, Machine Count switch activation, or Machine Count activations limited by a maximum time.

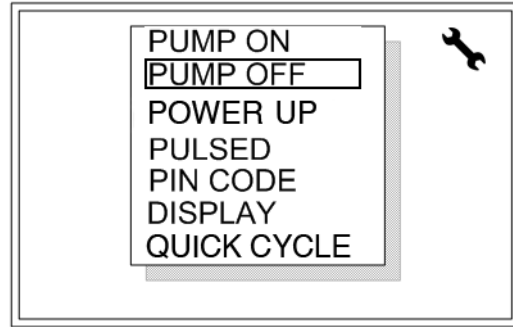

FIG. 29

1. Use the UP/DOWN Arrow keys to move the cursor over PUMP OFF.
2. Press ENTER to display the PUMP OFF setup screen.

To Set the Pump OFF Option

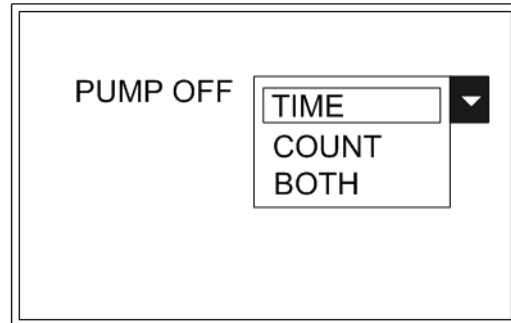
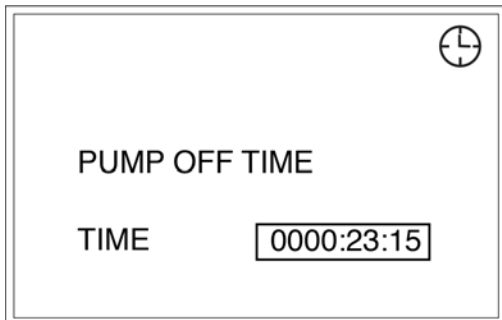

FIG. 30

1. Use the Arrow keys to move the cursor over the PUMP OFF pull-down menu.
2. Press ENTER.
3. Use the UP/DOWN Arrow keys to move cursor to select TIME, COUNT or BOTH.
4. After you make your selection, Press ENTER.

If TIME is selected:

If TIME is selected you will also be prompted to set the specific amount of time.

**FIG. 31**

1. Use the Arrow keys to move the cursor over the TIME field.
2. Press ENTER.

NOTE: Time is displayed in HH:MM:SS (Series E and earlier) or HHHH:MM:SS (Series F and later).

3. Use the UP/DOWN arrows to move up and down through the numbers 0-9 until the first number in the pump off TIME is displayed in the field.
4. Use the RIGHT arrow to move the cursor to the next field.
5. Repeat steps 3 and 4 until the desired time is displayed.
6. Press RESET. The Main Screen, page 24 displays.

If COUNT is selected:

If COUNT is selected you will also be prompted to set the specific number of counts.

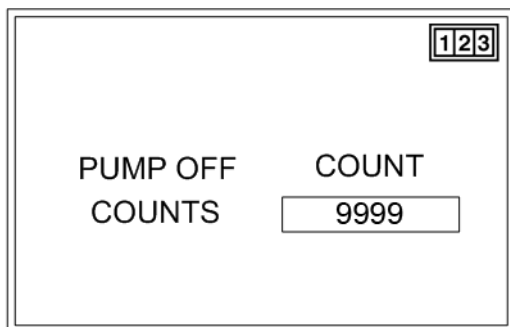
**FIG. 32**

1. Use the Arrow keys to move the cursor over the COUNTS field.
2. Press ENTER.
3. Use the UP/DOWN arrows to move up and down through the numbers 0-9 until the first number you want in the COUNTS field is displayed.
4. Use the RIGHT arrow to move the cursor to the next field. Repeat step 3.

NOTE: The maximum number of Counts you can setup in this field is 9999.

5. Press RESET. The Main Screen, page 24 displays.

If BOTH is selected:

If PUMP OFF is set to BOTH, the GLC 4400 will stay in the PUMP OFF state until the entered number of machine counts is received or the time expires.

If TIMEOUT is set to FAULT, an alarm will occur when the time expires.

If TIMEOUT is set to RUN, the unit will enter PUMP ON when time expires.

If BOTH is selected you will be prompted to set the specific amount of time and determine what occurs when time expires.

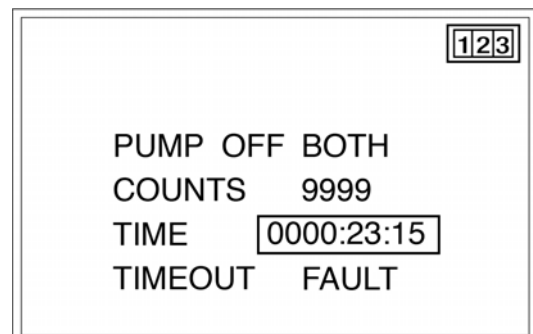
**FIG. 33**

1. Use the Arrow keys to move the cursor over the COUNTS field.
2. Press ENTER.
3. Use the UP/DOWN arrows to move up and down through the numbers 0-9 until the first number you want in the COUNTS field is displayed.

Setup

- Use the RIGHT arrow to move the cursor to the next field. Repeat step 3.

NOTE: The maximum number of Counts you can setup in this field is 9999.

- Use the Arrow keys to move the cursor over the TIME field.
- Press ENTER.

NOTE: Time is displayed in HH:MM:SS.

- Use the UP/DOWN arrows to move up and down through the numbers 0-9 until the first number in the PUMP OFF time is displayed in the field.
- Use the RIGHT arrow to move the cursor to the next field. Repeat step 7.
- Repeat steps 7 and 8 until the desired time is displayed.
- Press ENTER.
- Use the Arrow keys to move the cursor over the TIMEOUT pull-down menu.

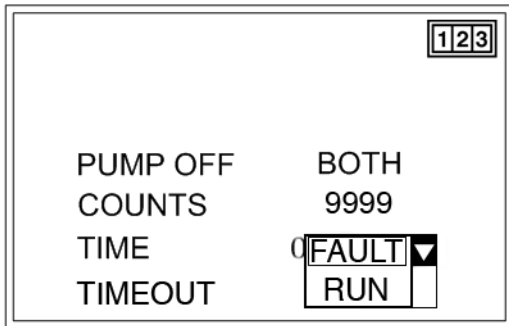

FIG. 34

- Press ENTER.
- When time expires:
 - Select FAULT if an alarm should occur.
 - Select RUN if unit should enter PUMP ON.
- Press ENTER.

- Series F and later models only - If RUN is selected for TIMEOUT, use the Arrow keys to move the cursor over the WARNING field. When this is set to ON, if the machine count is not met the controller will toggle Relay 3 and the Alarm LED on the controller will turn on.

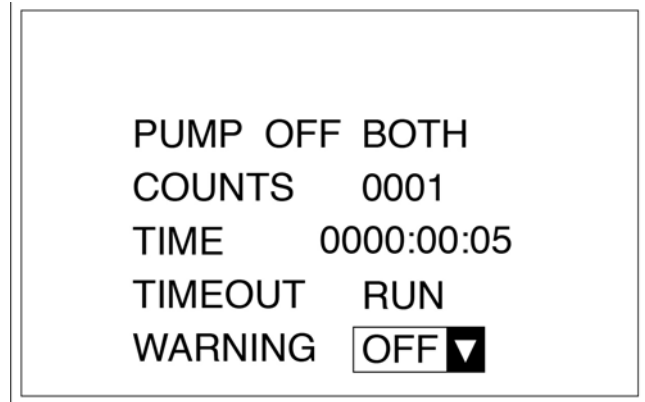

FIG. 35

- Press RESET. The Main Screen, page 24 displays.

NOTE: If Count or Both is selected, the Count Icon displays in the upper right corner of the screen.

POWER UP Setup

Define behavior of the controller during power ON. Default behavior is to continue program from point of power OFF.

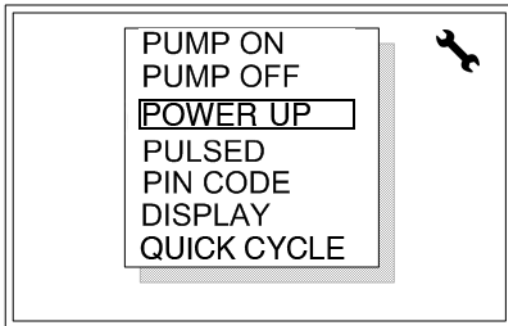

FIG. 36

1. Use the UP/DOWN Arrow keys to move the cursor over POWER UP.
2. Press ENTER to display the POWER UP setup screen.

Power Up can be programmed one of four ways:

First: At Power Up, the normal lube cycle that was in process when power was removed, is resumed.

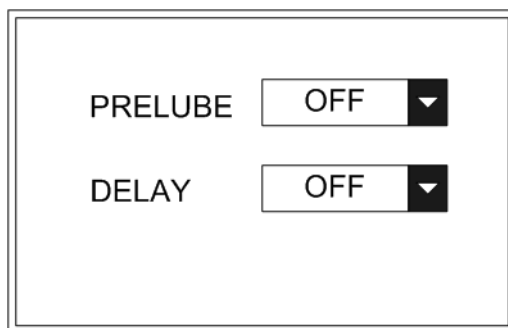

FIG. 37

1. Use the Arrow keys to move the cursor over the POWER UP pull-down menu.
2. From the pull-down menu, select OFF.
3. Press ENTER.
4. Use the Arrow keys to move the cursor over the DELAY pull-down menu.
5. From the pull-down menu, select OFF.

6. Press RESET. The Main Screen, page 24 displays.

Second: At Power Up, a delay occurs, the pump is off; then the normal lube cycle that was in process when power was removed, is resumed.

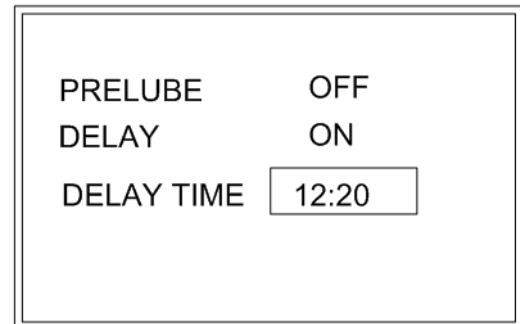

FIG. 38

1. Use the Arrow keys to move the cursor over the POWER UP pull-down menu.
 2. From the pull-down menu, select OFF.
 3. Press ENTER.
 4. Use the Arrow keys to move the cursor over the DELAY pull-down menu.
 5. From the pull-down menu, select ON.
 6. Press ENTER.
 7. Use the Arrow keys to move the cursor over the DELAY TIME field.
 8. Press ENTER.
- NOTE:** Time is displayed in HH:MM:SS (Series E and earlier) or HHHH:MM:SS (Series F and later).
9. Use the UP/DOWN arrows to move up and down through the numbers 0-9 until the first number in the DELAY TIME is displayed in the field.
 10. Use the RIGHT arrow to move the cursor to the next field. Repeat step 9.
 11. Repeat steps 9 and 10 until the desired time is displayed.
 12. Press RESET. The Main Screen, page 24 displays.

Third: At Power Up, immediately go to PUMP ON (normal on time)..

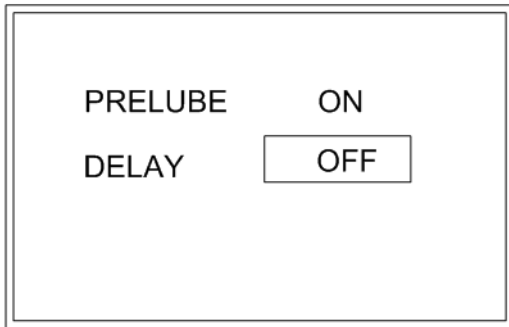

FIG. 39

1. Use the Arrow keys to move the cursor over the POWER UP pull-down menu.
2. From the pull-down menu, select ON.
3. Press ENTER.
4. Use the Arrow keys to move the cursor over the DELAY pull-down menu.
5. From the pull-down menu, select OFF.
6. Press RESET. The Main Screen, page 24 displays.

Fourth: At Power Up, go to programmed PUMP OFF delay time; then to normal PUMP ON.

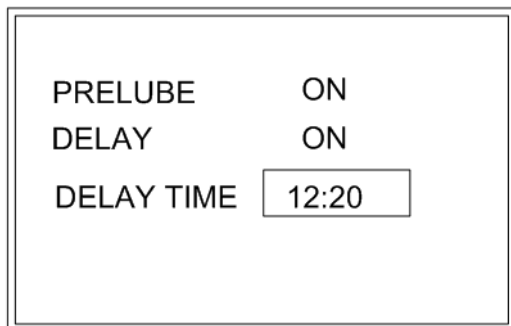

FIG. 40

1. Use the Arrow keys to move the cursor over the POWER UP pull-down menu.
2. From the pull-down menu, select ON.
3. Press ENTER.
4. Use the Arrow keys to move the cursor over the DELAY pull-down menu.

5. From the pull-down menu, select ON.
6. Press ENTER.
7. Use the Arrow keys to move the cursor over the DELAY TIME field.
8. Press ENTER.

NOTE: Time is displayed in MM:SS.

9. Use the UP/DOWN arrows to move up and down through the numbers 0-9 until the first number in the DELAY TIME is displayed in the field.
10. Use the RIGHT arrow to move the cursor to the next field. Repeat step 9.
11. Repeat steps 9 and 10 until the desired time is displayed.
12. Press RESET. The Main Screen, page 24 displays.

PULSED Setup

For systems requiring power to the pump to be turned on and off during a lubrication event, the user can utilize the pulse mode.

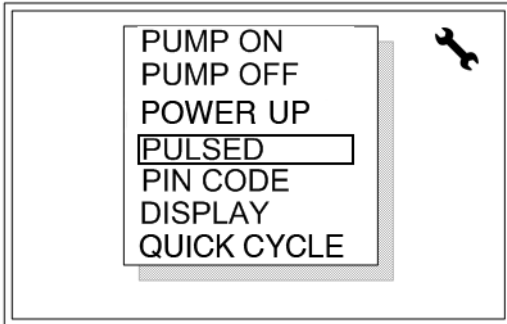

FIG. 41

1. Use the UP/DOWN Arrow keys to move the cursor over PULSED.
2. Press ENTER to display the PULSED setup screen.

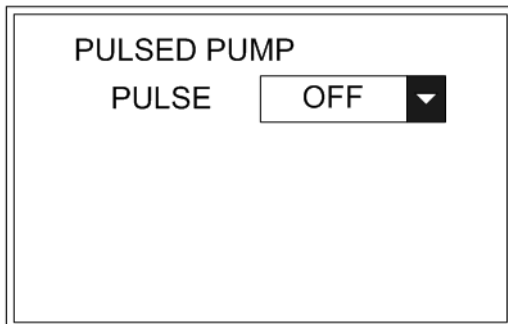

FIG. 42

Pulsed Pump Screen

1. Use the Arrow keys to move the cursor over the PULSE pull-down menu.
2. Press ENTER.
3. Use the UP/DOWN Arrow keys to move cursor to select ON.
4. Press ENTER.

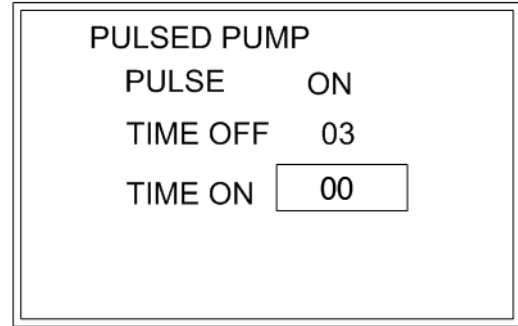

FIG. 43

5. Use the Arrow keys to move the cursor over the TIME OFF field.
6. Press ENTER.

NOTE: The time is displayed in Seconds.

7. Use the UP/DOWN arrows to move up and down through the numbers 0-9 until the first number of the TIME OFF you are creating is displayed in the field.
8. Use the RIGHT arrow to move the cursor to the next field. Repeat step 7.
9. Press ENTER.

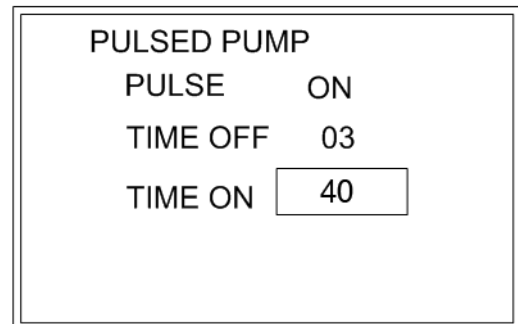

FIG. 44

10. Use the Arrow keys to move the cursor over the TIME ON field.
11. Press ENTER.

NOTE: The time is displayed in Seconds.

12. Use the UP/DOWN arrows to move up and down through the numbers 0-9 until the first number of the TIME ON you are creating is displayed in the field.

13. Use the RIGHT arrow to move the cursor to the next field. Repeat step 7.
14. Press ENTER.
15. Press RESET. The Main Screen, page 24 displays.

NOTE:

- The maximum Time Off and Time On is 99 seconds.
- The minimum Time Off is 3 seconds.
- The minimum Time On is 0 (zero) seconds.

PIN Setup

If protection for the setup mode is desired, a PIN Code entry can be enabled.

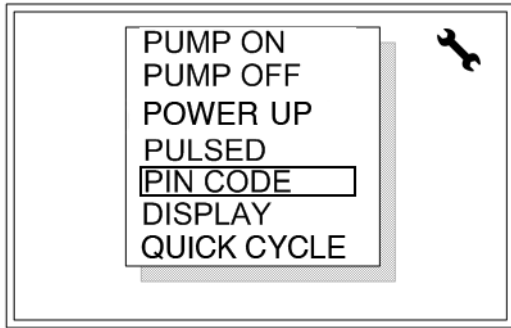

FIG. 45

1. Use the UP/DOWN Arrow keys to move the cursor over PIN CODE.
2. Press ENTER to display the PIN CODE setup screen.

To enable PIN Code Entry:

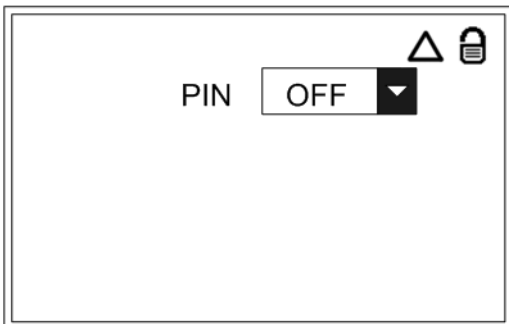

FIG. 46

1. Use the Arrow keys to move the cursor over the PIN pull-down menu.
2. Press ENTER.
3. Use the UP/DOWN Arrow keys to move cursor to select ON.
4. Press ENTER.

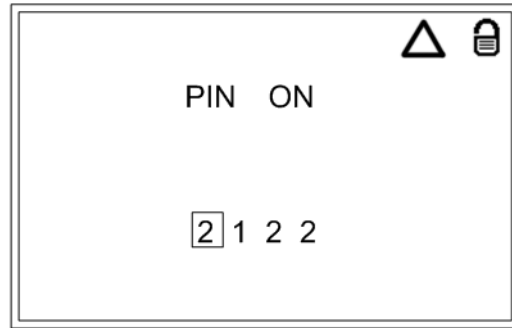

FIG. 47

5. Use the Arrow keys to move the cursor over the PIN CODE prompt field.
6. Use the LEFT/RIGHT arrow to position the cursor over the first blank Pin Code prompt field (FIG. 21).
7. Use the UP/DOWN arrows to move up and down through the numbers 0-9 until the first number in the PIN code you are creating is displayed in the field.
8. Use the RIGHT arrow to move the cursor to the next field. Repeat step 7
9. Repeat steps 7 and 8 for each PIN Code prompt.
10. Press RESET. The Main Screen, page 24 displays.

DISPLAY Setup

Adjust setting related to the display and backlight.

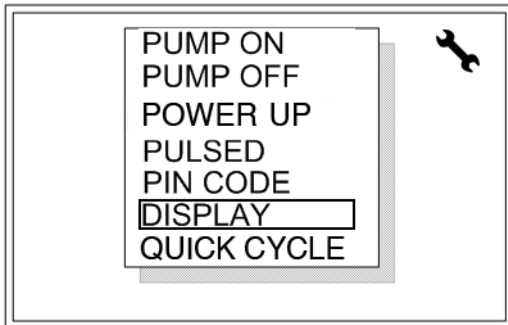

FIG. 48

1. Use the UP/DOWN Arrow keys to move the cursor over DISPLAY.
2. Press ENTER to display the DISPLAY setup screen.

Display Backlight

The display backlight can be set to turn off after a programmed amount of time. If the backlight is OFF it will turn back on when any front panel key is pressed.

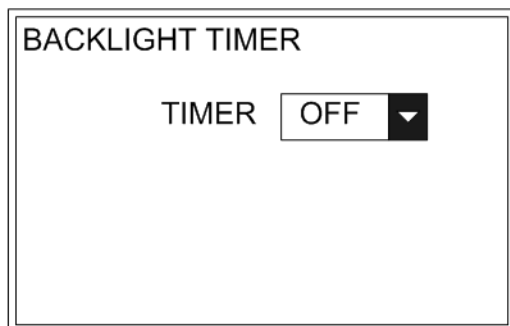

FIG. 49

1. Use the Arrow keys to move the cursor over the TIMER pull-down menu.
2. From the pull-down menu, select ON.
3. Press ENTER.

4. Use the Arrow keys to move the cursor over the TIME ON field.

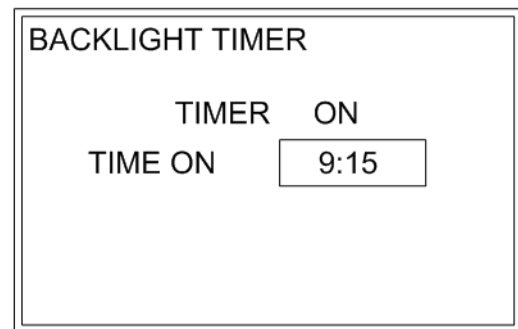

FIG. 50

NOTE: Time is displayed in HH:MM.

5. Use the UP/DOWN arrows to move up and down through the numbers 0-9 until the first number in the TIME ON is displayed in the field.
6. Use the RIGHT arrow to move the cursor to the next field. Repeat step 5.
7. Repeat steps 5 and 6 until the desired time displays.
8. Press RESET. The Main Screen, page 24 displays.

QUICK CYCLE Setup

Initiate a set of lubrication events for diagnostic or test purposes.

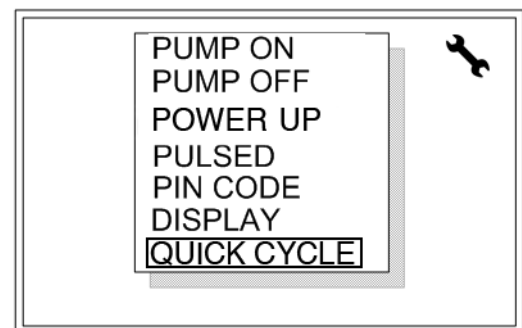

FIG. 51

1. Use the UP/DOWN Arrow keys to move the cursor over QUICK CYCLE.
2. Press ENTER to display the QUICK CYCLE setup screen.

Quick Cycle Screen Setup

The Quick Cycle screen setup is used to setup a Troubleshooting profile.

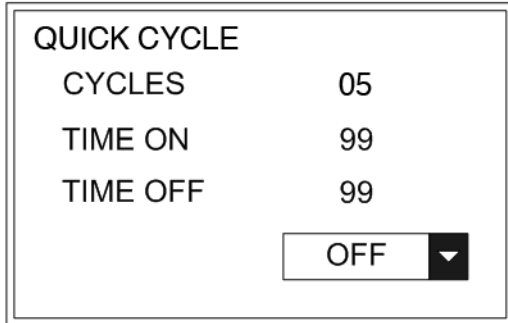

FIG. 52

1. Use the Arrow keys to move the cursor over the CYCLES field.
2. Press ENTER.
3. Use the UP/DOWN arrows to move up and down through the numbers 0-9 until the first number you want in the CYCLES field is displayed.
4. Use the RIGHT arrow to move the cursor to the next field. Repeat step 3.

NOTE: The maximum number of Cycles you can setup in this field is 99.

5. Use the Arrow keys to move the cursor over the TIME ON field.
6. Press ENTER.

NOTE: Time On and Time Off in QUICK CYCLE mode only, are displayed in Seconds.

7. Use the UP/DOWN arrows to move up and down through the numbers 0-9 until the first number you want to use in the TIME ON field is displayed in the field.
8. Use the RIGHT arrow to move the cursor to the next field. Repeat step 7.
9. Press ENTER.
10. Use the Arrow keys to move the cursor over the TIME ON field.
11. Press ENTER.

12. Repeat steps 7 - 9 for the TIME OFF field.
13. Use the Arrow keys to move the cursor over the pull-down menu.
14. Select ON.
15. The Quick Cycle begins.

NOTE:

- The maximum Time OFF and Time ON is 99 seconds.
- When complete, the system returns to the RUN MODE. It does not come back to the QUICK CYCLE setup screen.

LOW LEVEL FILTERING Setup

Configure the behavior of the Low Level input.

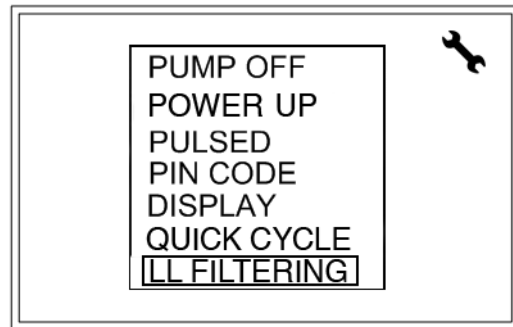

FIG. 53

1. Use the UP/DOWN Arrow keys to move the cursor over LL FILTERING.
2. Press ENTER to display the LL FILTERING setup screen.

Low Level Filtering Screen Setup

The LOW LEVEL FILTERING screen setup is used to filter out spurious signals from rotating paddle type low level sensors.

NOTE: When using the GLC4400 with the G3 Automatic Lubrication Pump, it is recommended that the low level filtering be set to G3 defaults.

The NUMBER field determines how many signal activations are required to set a fault.

The TIME field determines the amount of RUN time required without an activation to reset the activation count to 0 (zero).

MODE Field - (available in Series D or later models only)

The MODE field determines the behavior of the controller in a low level state. FAULT MODE will stop the pump when a low level is detected. The Alarm screen must be cleared before the pump will operate normally.

WARNING MODE will notify the user of a low level through the low level alarm contact, alarm LED and ALARM message on the screen. The pump will continue to operate normally.

NOTE:

- A WARNING MODE forces the number of signals to 1.
- In FAULT MODE when the number of signals is 1, the user must resolve the low level condition prior to clearing the error on the controller.

Sensor Field (Series E and earlier models only)

The SENSOR field identifies the behavior of the low level switch connected to the controller as Normally Open (NO) or Normally Closed (NC).

Normally Open (NO): Low Level input is inactive (example: Switch Open) when in normal state (not low).

Normally Closed (NC): Low Level input is active (example: Switch closed) when in a normal state (not low).

Sensor Field (Series F or later models only)

The LL RETRY field identifies the behavior of the Low Level Alarm upon a power cycle. The default is OFF. When this is set to ON the Low Level Alarm clears when the unit is first powered up and it will attempt the lubrication cycle, if the low level condition was cleared, it will continue normal operation, if not, it will go back to a Low Level Alarm state.

# OF SIG FOR LL & CLR TIME	
NUMBER	10
TIME	00:00:30
MODE	WARNING
SENSOR	NO
LL RETRY	OFF
G3 DEFAULTS	

FIG. 54

1. Use the Arrow keys to move the cursor over the NUMBER field.
2. Press ENTER.
3. Use the UP/DOWN arrows to move up and down through the numbers 0-9 until the first number you want in the NUMBER field is displayed.
4. Use the RIGHT arrow to move the cursor to the next field. Repeat step 3.

NOTE: The maximum number of Counts you can setup in this field is 99.

5. Use the Arrow keys to move the cursor over the TIME field.
6. Press ENTER.

NOTE: Time is displayed in HH:MM:SS.

7. Use the UP/DOWN arrows to move up and down through the numbers 0-9 until the first number in the TIME field is displayed.
8. Use the RIGHT arrow to move the cursor to the next field. Repeat step 7.
9. Repeat steps 7 and 8 until the desired time is displayed.

10. Press ENTER.
11. If the default values for the G3 Automatic Lubrication Pump are intended to be used, use the UP/DOWN arrows to move to the G3 DEFAULT field.
12. Press ENTER. The NUMBER and TIME values will be updated to the G3 default value.
13. If the WARNING MODE behavior is desired use the UP/DOWN arrows to move to the MODE field.
14. Press ENTER.
15. Use the UP/DOWN arrows to select between FAULT and WARNING.
16. Press ENTER. The selected mode should be shown in the MODE field.
17. Use the UP/DOWN arrows to move to the SENSOR field.
18. Press ENTER.
19. Use the UP/DOWN arrows to select between NO or NC.
20. Press ENTER. The selected sensor type should be shown in the SENSOR field.
21. To change the behavior of the LL Retry, use the UP/DOWN arrows to move to the LL RETRY field.
22. Press ENTER.
23. Use the UP/DOWN arrows to select between ON or OFF.
24. Press ENTER. The selected setting should be in the LL RETRY field.
25. Press RESET. The Main Screen, shown on page 24, displays.

SOLENOID ERROR Setup (Series F and later models only)

For systems requiring notification of a solenoid failure.

The system will go into a warning or fault if an user defined amount of cycles are detected in the Pump OFF sequence. A fault will shut off the pump and a warning will allow the pump to continue running while visually giving an error on the controller.

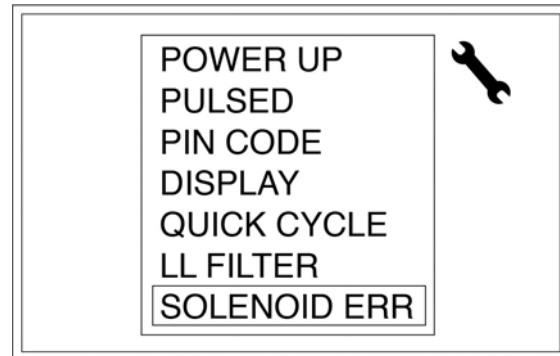

FIG. 55

1. Use the UP/DOWN Arrow keys to move the cursor over SOLENOID ERR.
2. Press ENTER to display the SOLENOID ERR setup screen (FIG. 56).

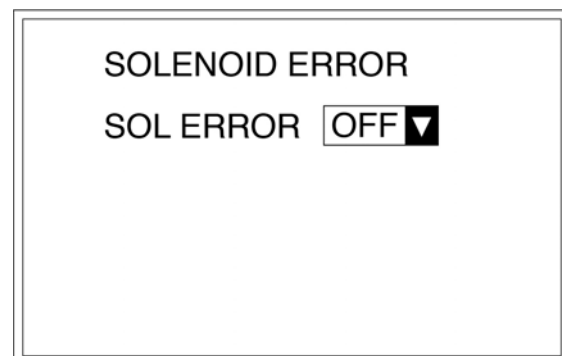

FIG. 56

1. Use the Arrow keys to move the cursor over the SOL ERROR pull-down menu.
2. Press ENTER.
3. Use the UP/DOWN Arrow keys to move cursor to select ON.
4. Press ENTER.

5. Use the Arrow keys to move the cursor over the COUNTS field.
6. Press ENTER.
7. Use the UP/DOWN arrows to move up and down through the numbers 0-9 until the first number of the COUNTS you are creating is displayed in the field.
8. Use the RIGHT arrow to move the cursor to the next field. Repeat Step 7.
9. Press ENTER.

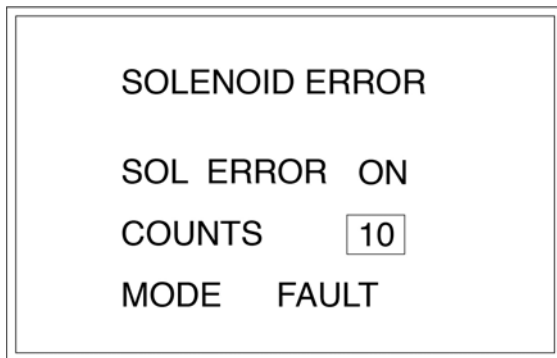

FIG. 57

10. If the WARNING mode behavior is desired, use the UP/DOWN arrows to move to the MODE field.
11. Press ENTER.
12. Use the UP/DOWN arrows to select between FAULT and WARNING.
13. Press ENTER.
14. Press RESET. The main screen is shown.

HIGH PRESSURE Setup (Series F and later)

For systems requiring notification of high pressure in the system by the use of an additional pressure switch.

The system will go into a warning or fault if the pressure switch is sensed at the user selected input of either input 3 or input 4. A fault will shut off the pump and a warning will allow the pump to still run while visually giving an error on the controller.

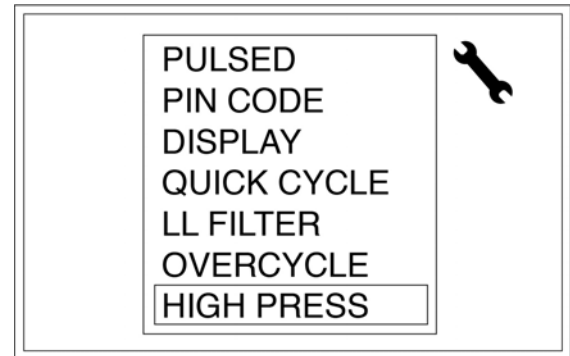

FIG. 58

1. Use the UP/DOWN Arrow keys to move the cursor over HIGH PRESS.
2. Press ENTER to display the HIGH PRESS setup screen.

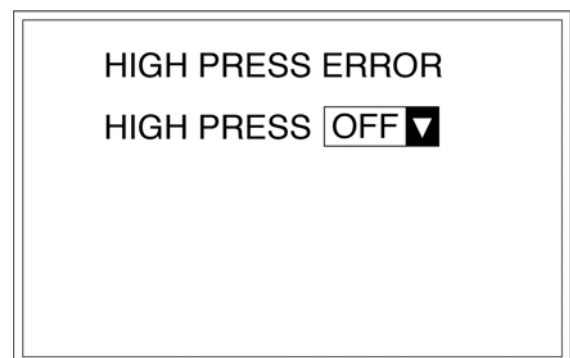

FIG. 59

3. Use the Arrow keys to move the cursor over the HIGH PRESS pull-down menu.
4. Press ENTER.
5. Use the UP/DOWN Arrow keys to move cursor to select ON.
6. Press ENTER.

7. Use the Arrow keys to move the cursor over the DIG IN field.
8. Press ENTER.
9. Use the UP/DOWN arrows to select either 3 or 4.
10. Press ENTER.

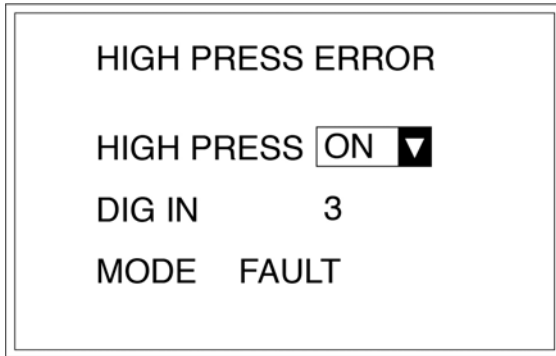

FIG. 60

11. If the WARNING mode behavior is desired, use the UP/DOWN arrows to move to the MODE field.
12. Press ENTER.
13. Use the UP/DOWN arrows to select between FAULT and WARNING.
14. Press ENTER.
15. Press RESET. The main screen is shown

RELAY SETUP Setup (Series F and Later)

For systems requiring customization of OUT2 (J7-5) and OUT3 (J7-7) relay functions.

By default, when a system goes into a Low level Fault/Warning, the OUT2 (J7-5) relay activates (turns ON). When a system goes into any other Fault/Warning, the OUT3 (J7-7) relay activates (turns ON). Customization of the relay function for Fault and Warning can be differentiated with the options of ON, toggle (TGL), and OFF.

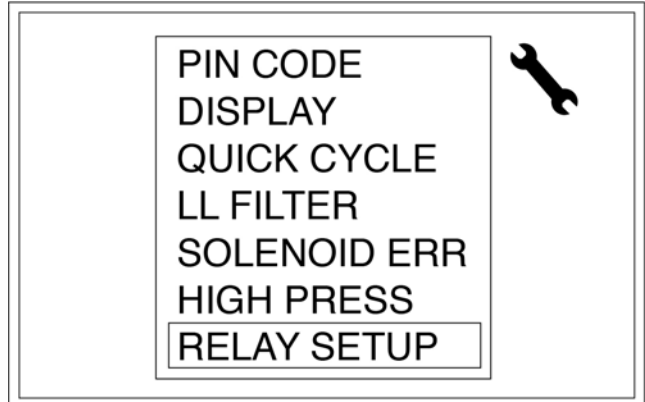

FIG. 61

1. Use the UP/Down Arrow keys to move the cursor over RELAY SETUP.
2. Press ENTER to display the RELAY SETUP SCREEN.

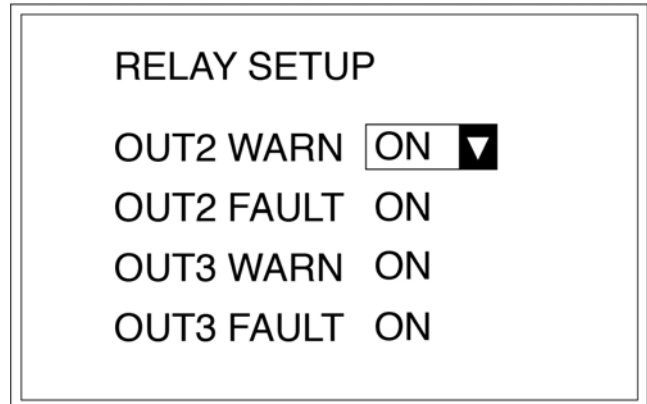

FIG. 62

3. Use the UP/DOWN Arrow keys to move the cursor over the relay that will be changed.
4. Press ENTER.
5. Use the UP/DOWN Arrow keys to move cursor to ON, TGL, or OFF.
6. Press ENTER.
7. Use the UP/DOWN Arrow keys to change any other relay if needed.
8. When done, press RESET. The main screen is shown.

Run Mode

When you first turn the Lubrication Controller power on, the identification screen shown in FIG. 63 displays.

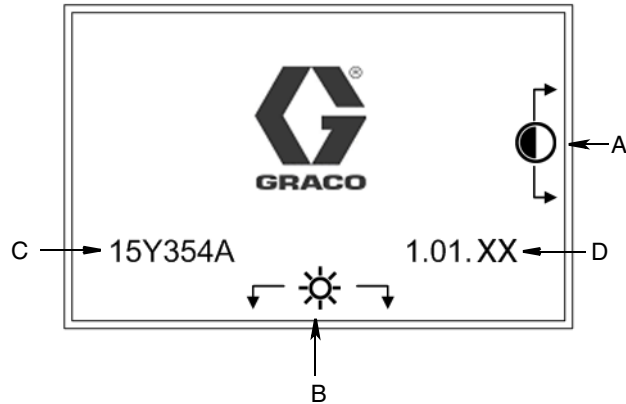

FIG. 63

- A **Display Contrast Adjustment:** UP and DOWN Arrows can be used to adjust the display contrast.
- B **Backlight Brightness Adjustment:** LEFT and RIGHT Arrows can be used to adjust the backlight brightness.

NOTE: Contrast and Brightness adjustments can be made on any Run Screen at any time.

- C **Software (Part Number):** 15Y354
- D **(Software) Version:** 1.01.XX

Screen Identification

The following screen is only shown as an example of the information that is displayed on a Run screen. A complete description of the icons and symbols shown in FIG. 64 is provided on page 3.

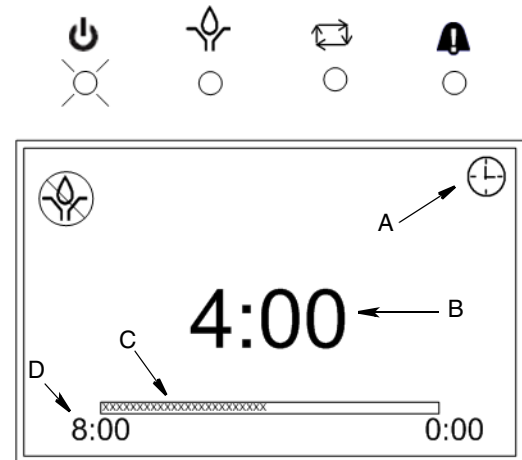

FIG. 64

- A **Operating Mode Identification** - Sets up Pump On/ Pump Off, page 29.
- B **Time Counter** - Actual elapsed time counts down while the pump runs - set up in Pump On Setup, page 24.
- C **Progression Bar** - Real-time, visual representation of the elapsed time the pump has been on. Runs in conjunction with B.
- D **Total Pump On Time** - Shows the total amount of time the pump is on. Setup on the Pump On setup screen, page 24.

Prelube Power Up



FIG. 65

If Prelube is enabled (page 29), the programmed pre-lube sequence occurs.

If no Prelube sequence has been selected, the lube cycle that was in progress at power down is resumed.

Pump On Ended with Time

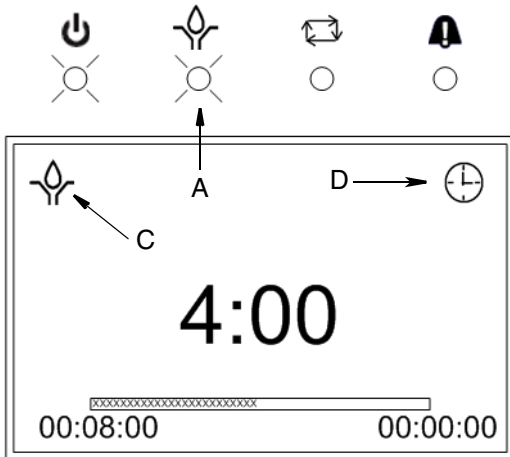

FIG. 66

If the Pump On sequence has been programmed to be ended by TIME:

- The GLC 4400 pump output relay activates (J7-3) and will stay on until the time expires. (see Setup Menus, Pump On, page 24).
- The Pump On LED (A) remains on during this time.

- The Pump On (C) icon displays.
- The Timer icon (D) displays and indicates the Timer Mode.

Pump On Ended with Pressure

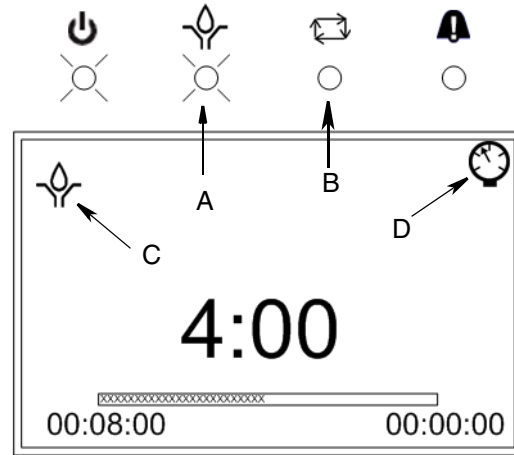

FIG. 67

If the Pump On sequence has been programmed to end by a pressure switch:

- The GLC 4400 pump output relay activates (J7-3) and will stay on until a switch closure is received (J6-3) (see Setup Menus, Pump On, page 25).
- The Pump On LED (A) remains on during this time.
- The Pump On (C) icon displays.
- The Cycle LED (B) illuminates and Pressure Mode icon (D) displays to indicate the pressure switch.
- If the pressure switch closure is not received before time expires, an alarm occurs.

NOTE: If Pump On is ended by a pressure switch and no Power Up delay is selected, when power to the GLC 4400 is turned on, the GLC 4400 starts at the beginning of the Pump On time instead of resuming the Pump On time where it left off.

Pump On Ended with Cycle Switch Activation

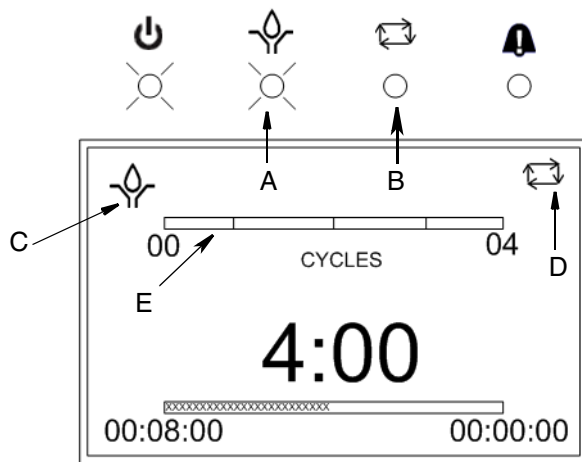

FIG. 68

If the Pump On sequence has been programmed to end by a Cycle Switch Activation:

- The GLC 4400 pump output relay activates (J7-3) and will stay on until the correct number of cycle switch closures is received (J6-3) (see Setup Menus, Cycle End Setup page 25).
- The Pump On LED (A) remains on during this time.
- The Pump On (C) icon displays.
- The Cycle LED (B) and Cycle Count Mode icon (D) display indicating the cycle switch is activated.
- The cycle indicator bar (E) displays a visual representation of the cycle switch closures received.
- If the set number of cycle switch closures is not received before time expires, an alarm occurs.

Pump Off Ended with Time

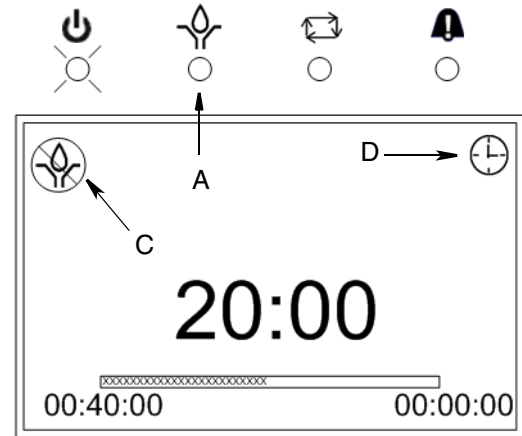

FIG. 69

If the Pump Off sequence has been programmed to be ended by TIME:

- The GLC 4400 pump output relay deactivates (J7-3) and will stay off until the time expires. (see Setup Menus, Pump Off, page 26).
- The Pump On LED (A) remains off during this time.
- The Pump Off icon (C) displays.
- The Timer Mode icon (D) displays and indicates the Timer Mode.

Pump Off Ended with Machine Counts

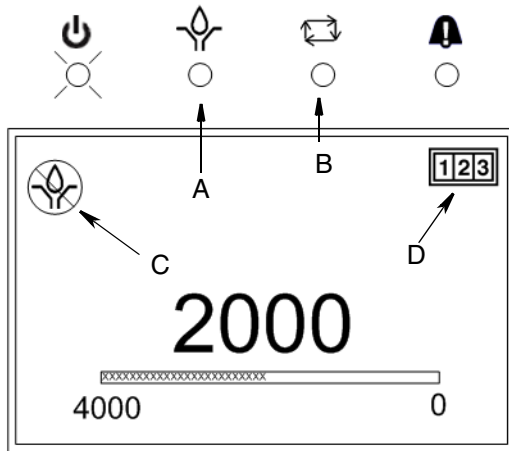

FIG. 70

If the Pump Off sequence has been programmed to be ended by MACHINE COUNTS:

- The GLC 4400 pump output relay deactivates (J7-3) and will stay off until the correct number of counts (J6-15) occur (see Setup Menus, Pump Off, page 26).
- The Pump On LED (A) remains off during this time.
- The Pump Off icon (C) displays.
- The Cycle LED (B) and Machine Count icon (D) display and indicate the Machine Count Switch activation.

Pump Off Ended with Machine Counts; Max Time Entered

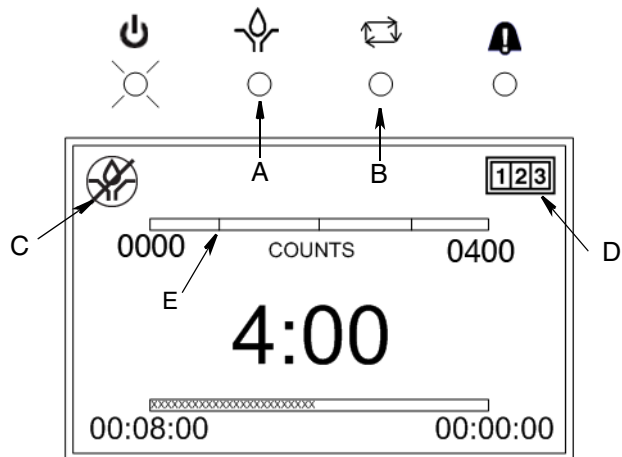

FIG. 71

If the Pump Off sequence has been programmed to be ended by MACHINE COUNTS with a maximum time:

- The GLC 4400 pump output relay deactivates (J7-3) and will stay off until the correct number of counts (J6-15) occur (see Setup Menus, Pump Off, page 26).
- The Pump On LED (A) remains off during this time.
- The Pump Off icon (C) displays.
- The Cycle LED (B) and Machine Count icon (D) display and indicate the Machine Count Switch activation.
- The counts indicator bar (E) displays a visual representation of the machine counts received.
- If the set number of machine counts is not received before time expires, an alarm occurs.

Alarms Screen

When an alarm event occurs, Alarm screen as shown in FIG. 72 displays.

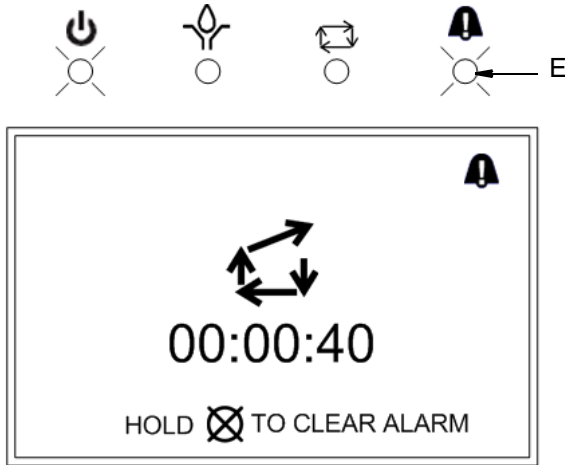

FIG. 72

- The Alarm LED (E, FIG. 72) will flash during this time.
- If this is a Low Level Alarm, the Low Level relay activates (J7-5) and will stay on until the alarm is cleared.
- For any other alarm than Low Level, the Alarm relay activates (J7-7) and will stay on until the alarm is cleared.
- All alarms deactivate the O.K. contact (J7-9) and it will stay off until the alarm is cleared.
- To clear an alarm, hold down the Clear Key on the display Keypad (see page 3).

Warnings Screen

When a warning event occurs, the Warning screen shown in FIG. 73 displays.

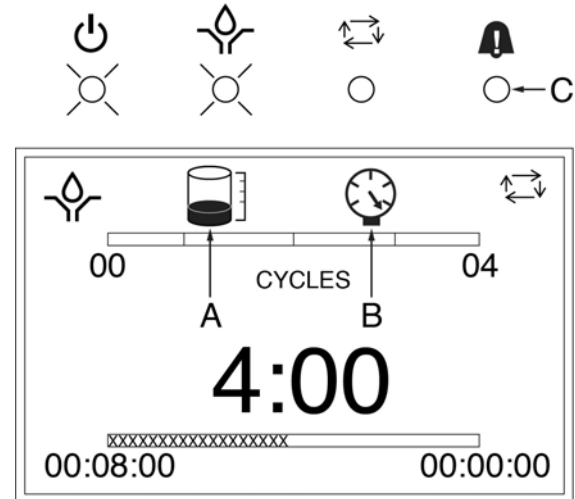

FIG. 73

- For any warning other than Low Level, the Alarm relay activates (J7-7) and will stay on until the warning is cleared either by the reset button, or correcting the condition.
- All warnings are self-clearing.
- If a warning occurs, the appropriate icon (A) displays.
- If more than one warning occurs, an additional icon (B) displays.
- The Alarm LED (C) remains on during this time.
- If this is a Low Level Warning, the Low Level relay activates (J7-5) and will stay on until the condition is cleared.
- To clear a warning, press the clear key on the display Keypad (see page 3).

See page 4 for a listing of alarm/warning events that may display.

Troubleshooting

Description	Problem	Solution
Timer fails to activate solenoid	No power supplied to solenoid	Power light off: Timer is not receiving power. Verify connections and verify power supply.
		Power light on: Verify solenoid connections
	Solenoid faulty	Replace solenoid
	Timer faulty	Replace timer
Pressure switch fails to shut down system	Low level or other alarm	Refill reservoir
	Pressure switch incorrectly wired	Verify proper connections
	Pressure switch faulty	Replace pressure switch
	Timer faulty	Replace timer

Program Settings

Description	Modes of Operation Maximum / Minimum and Additional Comments
CYCLE MODE Selection, page 26	Cycles = 01 - 99 (Series E and earlier); 0001-9999 (Series F and later)
PUMP ON Setup, page 24	Time, Pressure or Cycles Pump ON Time: HH:MM:SS (00:00:01 - 99:59:59) Cycles: 01 - 99 (only used when mode of operation = cycles, Series E and earlier); 0001-9999 (Series F and later)
PUMP OFF Setup, page 26	Time, Count or Both Pump OFF Time: HH:MM:SS. (00:00:01 - 99:59:59, Series E and earlier) HHHH:MM:SS (0000:00:01-9999:59:59, Series F and later) Count: 01 - 9999 TIMEOUT RUN/FAULT WARNING ON/OFF
PULSED Output (pump), page 31	Maximum Time OFF and Time ON: SS (01-99)
PIN Number Setup, page 32	ON / OFF 0000 - 9999
QUICK CYCLE SCREEN Setup, page 33	Cycles = 01 - 99 Time ON and Time OFF: SS (01-99) Execute: YES / NO

Description	Modes of Operation Maximum / Minimum and Additional Comments
LOW LEVEL FILTERING Setup, page 34	Number = 01 - 99 Time: HH:MM:SS Mode: Fault / Warning Sensor: NO / NC
SOLENOID ERROR Setup (Series F later), page 36	ON / OFF Counts = 01 - 99 Mode: Fault / Warning
HIGH PRESSURE Setup (Series F and later), page 37	ON / OFF Dig In: 3 / 4 Mode: Fault / Warning
PRELUBE on Power Up Setup, page 40	YES / NO Delay: YES / NO TIME: MM:SS (00:01 - 59:59)
RELAY Setup	OUT2 WARN: ON/TGL/OFF OUT2 FAULT: ON/TGL/OFF OUT3 WARN: ON/TGL/OFF OUT4 FAULT: ON/TGL/OFF

Technical Data

Input Contact	
Power Source DC - model 24B591	9 - 30 VDC
Power Source AC - model 24B596	100 VAC to 240 VAC - 50/60 Hz
Power consumption	24 Watts
Cycle Pressure Control Input (optional)	Normally open pressure or cycle switch
Machine Count Control Input (optional)	Machine count control switch
Lubrication level (optional)	Normally open level switch, closes upon low level
Remote Manual Run Input	Normally open remote manual run switch
Outputs	
Pump control	Pump Control Voltage = Power Source
Voltage	Power Source
Max Switching Voltage	250 VAC, 100 VDC
Max Switching Current	10 A (AC), 5A (DC)
Minimum Switching Capacity	100 mA @ 5 VDC
Switch Life (estimate)	Hardware rated for 100,000 switch closures
Low Level Alarm, normally open (optional)	
Voltage	Power Source
Max Switching Voltage	250 VAC, 30 VDC
Max Switching Current	5A (AC), 5A (DC)
Minimum Switching Capacity	100 mA @ 5 VDC
Auxiliary Alarm, normally open (optional)	
Voltage	Power Source
Max Switching Voltage	250 VAC, 30 VDC
Max Switching Current	5A (AC), 5A (DC)
Minimum Switching Capacity	100 mA @5 VDC
Status OK, normally open (optional)	Voltage-free Contact
Voltage	Power Source
Max Switching Voltage	250 VAC, 100 VDC
Max Switching Current	10 A (AC), 5A (DC)
Minimum Switching Capacity	100 mA @ 5 VDC
Protection grade	IP69K
Enclosure Material	Fiberglass reinforced polyester
Membrane Material	Polyester
Bushing	Ethylene Propylene Diene Monomer Rubber (EDPM)
Operating temperature range	- 40°F to 145°F (- 40°C to 63°C)
Storage Temperature	- 13°F to 145°F (- 25°C to 63°C)

Dimensions

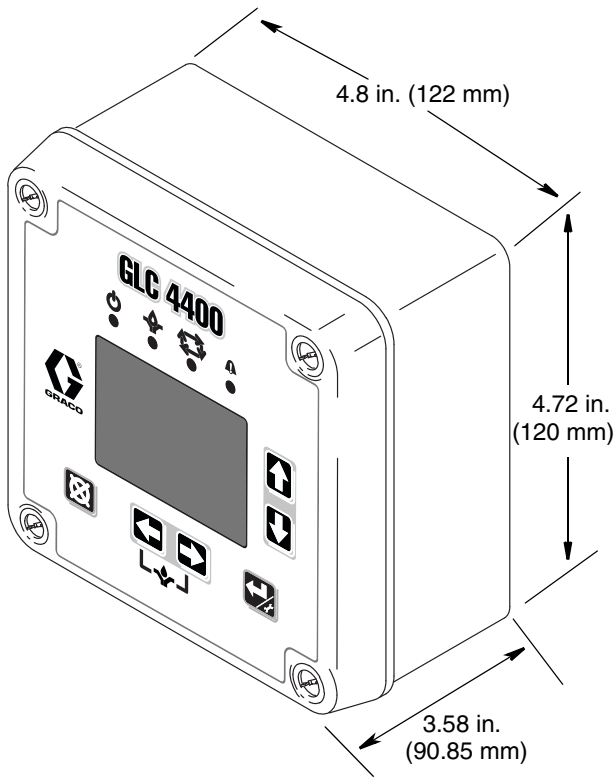

Mounting Hole Layout

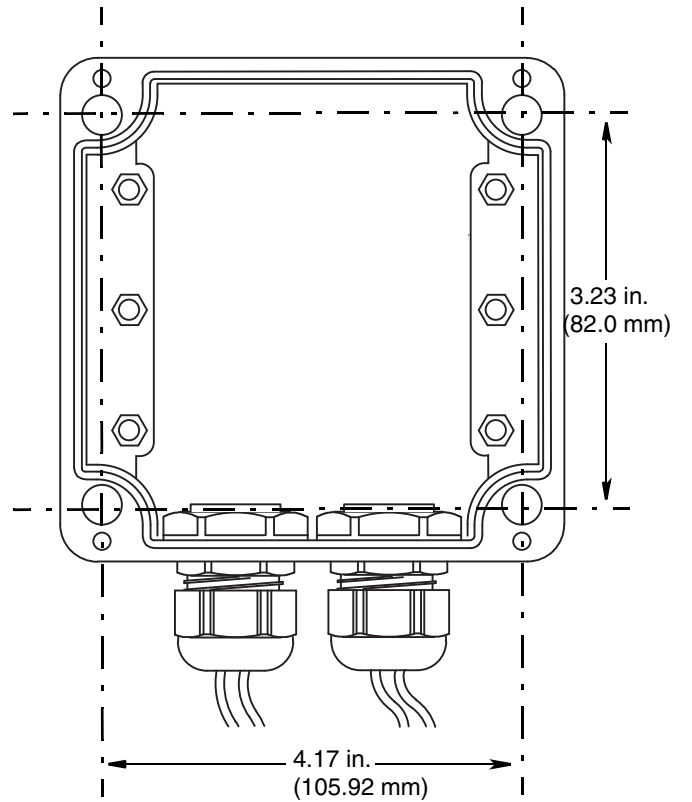

Graco Standard Warranty

Graco warrants all equipment referenced in this document which is manufactured by Graco and bearing its name to be free from defects in material and workmanship on the date of sale to the original purchaser for use. With the exception of any special, extended, or limited warranty published by Graco, Graco will, for a period of twelve months from the date of sale, repair or replace any part of the equipment determined by Graco to be defective. This warranty applies only when the equipment is installed, operated and maintained in accordance with Graco's written recommendations.

This warranty does not cover, and Graco shall not be liable for general wear and tear, or any malfunction, damage or wear caused by faulty installation, misapplication, abrasion, corrosion, inadequate or improper maintenance, negligence, accident, tampering, or substitution of non-Graco component parts. Nor shall Graco be liable for malfunction, damage or wear caused by the incompatibility of Graco equipment with structures, accessories, equipment or materials not supplied by Graco, or the improper design, manufacture, installation, operation or maintenance of structures, accessories, equipment or materials not supplied by Graco.

This warranty is conditioned upon the prepaid return of the equipment claimed to be defective to an authorized Graco distributor for verification of the claimed defect. If the claimed defect is verified, Graco will repair or replace free of charge any defective parts. The equipment will be returned to the original purchaser transportation prepaid. If inspection of the equipment does not disclose any defect in material or workmanship, repairs will be made at a reasonable charge, which charges may include the costs of parts, labor, and transportation.

THIS WARRANTY IS EXCLUSIVE, AND IS IN LIEU OF ANY OTHER WARRANTIES, EXPRESS OR IMPLIED, INCLUDING BUT NOT LIMITED TO WARRANTY OF MERCHANTABILITY OR WARRANTY OF FITNESS FOR A PARTICULAR PURPOSE.

Graco's sole obligation and buyer's sole remedy for any breach of warranty shall be as set forth above. The buyer agrees that no other remedy (including, but not limited to, incidental or consequential damages for lost profits, lost sales, injury to person or property, or any other incidental or consequential loss) shall be available. Any action for breach of warranty must be brought within two (2) years of the date of sale.

GRACO MAKES NO WARRANTY, AND DISCLAIMS ALL IMPLIED WARRANTIES OF MERCHANTABILITY AND FITNESS FOR A PARTICULAR PURPOSE, IN CONNECTION WITH ACCESSORIES, EQUIPMENT, MATERIALS OR COMPONENTS SOLD BUT NOT MANUFACTURED BY GRACO. These items sold, but not manufactured by Graco (such as electric motors, switches, hose, etc.), are subject to the warranty, if any, of their manufacturer. Graco will provide purchaser with reasonable assistance in making any claim for breach of these warranties.

In no event will Graco be liable for indirect, incidental, special or consequential damages resulting from Graco supplying equipment hereunder, or the furnishing, performance, or use of any products or other goods sold hereto, whether due to a breach of contract, breach of warranty, the negligence of Graco, or otherwise.

FOR GRACO CANADA CUSTOMERS

The Parties acknowledge that they have required that the present document, as well as all documents, notices and legal proceedings entered into, given or instituted pursuant hereto or relating directly or indirectly hereto, be drawn up in English. Les parties reconnaissent avoir convenu que la rédaction du présente document sera en Anglais, ainsi que tous documents, avis et procédures judiciaires exécutés, donnés ou intentés, à la suite de ou en rapport, directement ou indirectement, avec les procédures concernées.

Graco Information

For the latest information about Graco products, visit www.graco.com.

TO PLACE AN ORDER, contact your Graco distributor or call to identify the nearest distributor.

Phone: 612-623-6928 or Toll Free: 1-800-533-9655, Fax: 612-378-3590

*All written and visual data contained in this document reflects the latest product information available at the time of publication.
Graco reserves the right to make changes at any time without notice.*

For patent information, see www.graco.com/patents.

Original instructions. This manual contains English. MM 313855

Graco Headquarters: Minneapolis

International Offices: Belgium, China, Japan, Korea

GRACO INC. AND SUBSIDIARIES • P.O. BOX 1441 • MINNEAPOLIS MN 55440-1441 • USA

Copyright 2009, Graco Inc. All Graco manufacturing locations are registered to ISO 9001.

www.graco.com

Revised September 2018