



ProMix® PD2K Electronic Proportioner

332562F
EN

Electronic positive displacement proportioner for 2-component materials. Manual system with Advanced Display Module. For professional use only.



Important Safety Instructions

Read all warnings and instructions in this manual and in your PD2K Installation and Repair/Parts manuals. **Save these instructions.**

See page 3 for model part numbers and approvals information.

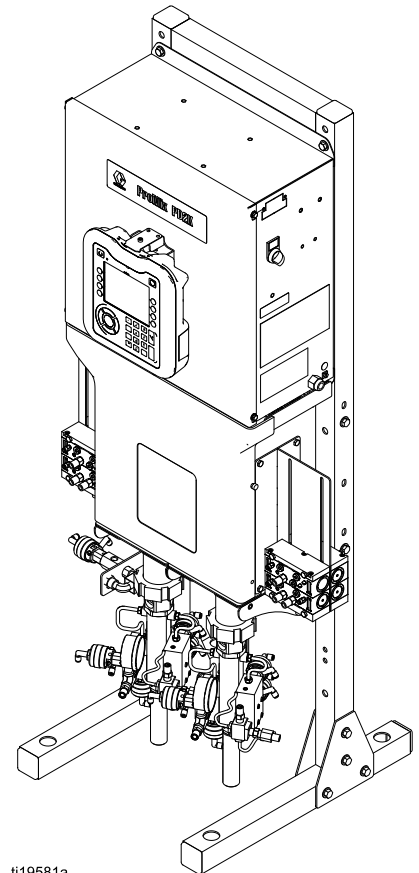

ti19581a

Contents

Models.....	3	Jobs Screen	38
Related Manuals	6	Errors Screen	38
Warnings	7	Events Screen	38
Important Isocyanate (ISO) Information.....	10	Setup Mode Screens	39
Important Acid Catalyst Information	12	Password Screen.....	39
Acid Catalyst Conditions.....	12	System Screen 1	40
Moisture Sensitivity of Acid Catalysts	12	System Screen 2	41
Glossary of Terms	13	System Screen 3	43
Overview.....	14	Information for Systems with Multiple	
Usage	14	Guns.....	44
Component Identification and		Gateway Screen	49
Definition.....	14	Recipe Screen	50
Advanced Display Module	17	Flush Screen	53
ADM Display.....	17	Air/Solvent Chop.....	54
USB Download Procedure	17	Pump Screen 1	55
USB Upload Procedure	18	Custom Valve Mapping	57
ADM Keys and Indicators	19	Pump Screen 2	61
Soft Key Icons	20	Pump Screen 3	62
Navigating the Screens	21	Pump Screen - Material Assignment	62
Screen Icons	21	Calibrate Screen 1	63
Booth Control	22	Calibrate Screen 2	64
Booth Control Display.....	22	Calibrate Screen 3	65
Booth Control Keys and Indicators	23	Maintenance Screen 1	66
Pre-Operation Tasks.....	24	Maintenance Screen 2	66
Pre-operation Checklist	24	Maintenance Screen 3	66
Power On	24	Maintenance Screen 4	67
Initial System Setup	24	Maintenance Screen 5	67
Flush Before Using Equipment.....	25	Advanced Screen 1	68
Valve Settings.....	25	Advanced Screen 2	69
Pressure Relief Procedure	26	Advanced Screen 3	69
Without Color Change	26	Advanced Screen 4	70
With Color Change.....	26	Diagnostic Screens	71
Operation.....	27	Calibration Checks.....	72
Prime and Fill the System.....	27	Pump Pressure Check	72
Pre-Fill the Pump	27	Pump Volume Check.....	73
Spraying.....	28	Solvent Meter Calibration	74
Purging	29	Color Change	75
Shutdown	31	Single Color Systems	75
Run Mode Screens	32	Multiple Color Systems.....	75
Splash Screen	32	System Errors	76
Home Screen	32	On-Screen Help.....	76
Spray Screen.....	35	Maintenance	93
Fill Screen	36	Preventive Maintenance Schedule	93
Usage Screen.....	37	Flushing	93
		Cleaning the ADM.....	93
		Technical Data	94

Models

See Figs. 1–7 for component identification labels, including approval information and certification.

Part No.	Series	Maximum Air Working Pressure	Maximum Fluid Working Pressure	Location of PD2K and Electrical Control Box (ECB) Labels
MC0500	A	100 psi (0.7 MPa, 7.0 bar)	With low-pressure pumps: 300 psi (2.068 MPa, 20.68 bar)	
			With high-pressure pumps: 1500 psi (10.34 MPa, 103.4 bar)	
MC1000	A	100 psi (0.7 MPa, 7.0 bar)	300 psi (2.068 MPa, 20.68 bar)	
MC3000 Acid-based Material				
MC2000	A	100 psi (0.7 MPa, 7.0 bar)	1500 psi (10.34 MPa, 103.4 bar)	
MC4000 Acid-based Material				



**ProMix® PD2K/PD1K
Electronic Proportioner**

II 2 G
Ex ia IIA T3
FM13 ATEX 0026
IECEX FMG 13.0011

CE 0359

FM16US0241
FM16CA0129
Intrinsically safe
equipment for Class I,
Div 1, Group D, T3
Ta = 2°C to 50°C

MAX AIR WPR

.7	7	100
MPa	bar	PSI

MAX FLUID WPR

2.068	20.68	300
MPa	bar	PSI

MAX TEMP 50°C (122°F)

Intrinsically Safe (IS) System. Install per IS Control Drawing No. 16P577. Control Box IS Associated Apparatus for use in non hazardous location, with IS Connection to color change and booth control modules Apparatus for use in: Class I, Division 1, Group D T3 Hazardous Locations

Read Instruction Manual
Warning: Substitution of components may impair intrinsic safety.

PART NO.	SERIES	SERIAL





MFG. YR.

Artwork No. 294021 Rev. F

GRACO INC.
P.O. Box 1441
Minneapolis, MN
55440 U.S.A.





Figure 1 Model MC1000 & MC3000 (Low Pressure) Identification Label

Continued on the next page.

ProMix® PD2K/PD1K			POWER REQUIREMENTS		
PART NO.	SERIES NO.	MFG. YR.	VOLTS	90-250 ~	
			AMPS	7 AMPS MAX	
				50/60 Hz	
 GRACO INC. P.O. Box 1441 Minneapolis, MN 55440 U.S.A.		 Intrinsicly safe connections for Class I, Div 1, Group D Ta = 2°C to 50°C Install per 16P577 APPROVED FM16US0241 FM16CA0129 Um: 250 V		 II (2) G [Ex ia] IIA Gb FM13 ATEX 0026 IECEx FMG 13.0011	
			 0359		



Artwork No. 294024 Rev. D

Figure 2 24M672 Control Box Identification Label

ProMix® PD2K/PD1K			Electronic Proportioner		
 II 2 G Ex ia IIA T3 FM13 ATEX 0026 IECEx FMG 13.0011			 0359		
			 APPROVED FM16US0241 FM16CA0129 Intrinsicly safe equipment for Class I, Div 1, Group D, T3 Ta = 2°C to 50°C		
Intrinsicly Safe (IS) System. Install per IS Control Drawing No. 16P577. Control Box IS Associated Apparatus for use in non hazardous location, with IS Connection to color change and booth control modules Apparatus for use in: Class I, Division 1, Group D T3 Hazardous Locations Read Instruction Manual Warning: Substitution of components may impair intrinsic safety.					
MAX AIR WPR					
.7	7	100			
MPa	bar	PSI			
MAX FLUID WPR					
10.34	103.4	1500			
MPa	bar	PSI			
MAX TEMP 50°C (122°F)					
			PART NO. SERIES SERIAL [] [] []		
			MFG. YR. []		
			 GRACO INC. P.O. Box 1441 Minneapolis, MN 55440 U.S.A.		





Artwork No. 294022 Rev. F

Figure 3 Model MC2000 & MC4000 (High Pressure) Identification Label

ProMix® PD2K/PD1K COLOR CHANGE CONTROL					
PART NO.	SERIES	SERIAL	MFG. YR.	MAX AIR WPR	
				.7	7
				MPa	bar
					100
					PSI
 GRACO INC. P.O. Box 1441 Minneapolis, MN 55440 U.S.A.					

Artwork No. 294057 Rev. C

Figure 4 Non-Intrinsicly Safe Color Change Control (Accessory) Identification Label

ProMix® PD2K/PD1K COLOR CHANGE CONTROL					
PART NO.	SERIES	SERIAL	MFG. YR.	MAX AIR WPR	
				.7	7
				MPa	bar
					100
					PSI
 Intrinsicly safe equipment for Class I, Div 1, Group D, T3 Ta = 2°C to 50°C Install per 16P577 APPROVED FM16US0241 FM16CA0129		 II 2 G Ex ia IIA T3 Gb FM13 ATEX 0026 IECEx FMG 13.0011		 0359	
 GRACO INC. P.O. Box 1441 Minneapolis, MN 55440 U.S.A.					

Artwork No. 294055 Rev. C

Figure 5 Intrinsicly Safe Color Change Control (Accessory) Identification Label

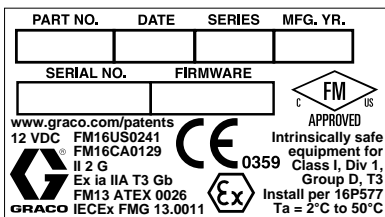

Figure 6 Booth Control Identification Label

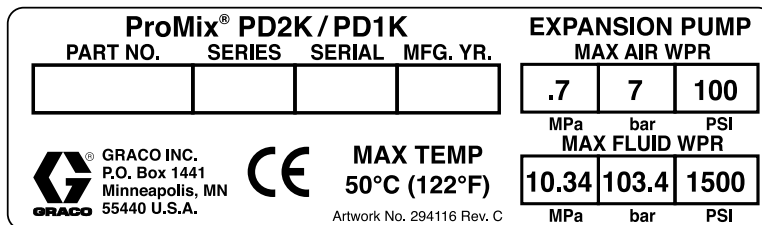









Figure 7 Pump Expansion Kit (Accessory) Identification Label











Related Manuals







Manual No.	Description
3A2800	PD2K Proportioner Repair-Parts Manual, Manual Systems
332457	PD2K Proportioner Installation Manual, Manual Systems
3A2801	Mix Manifold Instructions-Parts Manual
332339	Pump Repair-Parts Manual
332454	Color Change Valve Repair-Parts Manual
332455	Color Change Kits Instructions-Parts Manual
332456	3rd and 4th Pump Kits Instructions-Parts Manual
333282	Color Change and Remote Mix Manifold Kits Instructions-Parts Manual
334512	PD1K Pump Expansion Kits Instructions-Parts Manual

Warnings

The following warnings are for the setup, use, grounding, maintenance and repair of this equipment. The exclamation point symbol alerts you to a general warning and the hazard symbol refers to procedure-specific risks. When these symbols appear in the body of this manual or on warning labels, refer back to these Warnings. Product-specific hazard symbols and warnings not covered in this section may appear throughout the body of this manual where applicable.

 <h2 style="margin: 0;">WARNING</h2>	
   	<p>FIRE AND EXPLOSION HAZARD</p> <p>Flammable fumes, such as solvent and paint fumes, in work area can ignite or explode. Paint or solvent flowing through the equipment can cause static sparking. To help prevent fire and explosion:</p> <ul style="list-style-type: none"> • Use equipment only in well ventilated area. • Eliminate all ignition sources; such as pilot lights, cigarettes, portable electric lamps, and plastic drop cloths (potential static arc). • Ground all equipment in the work area. See Grounding instructions. • Never spray or flush solvent at high pressure. • Keep work area free of debris, including solvent, rags and gasoline. • Do not plug or unplug power cords, or turn power or light switches on or off when flammable fumes are present. • Use only grounded hoses. • Hold gun firmly to side of grounded pail when triggering into pail. Do not use pail liners unless they are antistatic or conductive. • Stop operation immediately if static sparking occurs or you feel a shock, Do not use equipment until you identify and correct the problem. • Keep a working fire extinguisher in the work area.
 	<p>ELECTRIC SHOCK HAZARD</p> <p>This equipment must be grounded. Improper grounding, setup, or usage of the system can cause electric shock.</p> <ul style="list-style-type: none"> • Turn off and disconnect power at main switch before disconnecting any cables and before servicing or installing equipment. • Connect only to grounded power source. • All electrical wiring must be done by a qualified electrician and comply with all local codes and regulations.





 <h1 style="margin: 0;">WARNING</h1>	
  	<p>INTRINSIC SAFETY</p> <p>Intrinsically safe equipment that is installed improperly or connected to non-intrinsically safe equipment will create a hazardous condition and can cause fire, explosion, or electric shock. Follow local regulations and the following safety requirements.</p> <ul style="list-style-type: none"> • Be sure your installation complies with national, state, and local codes for the installation of electrical apparatus in a Class I, Group D, Division 1 (North America) or Class I, Zones 1 and 2 (Europe) Hazardous Location, including all of the local safety fire codes (for example, NFPA 33, NEC 500 and 516, OSHA 1910.107, etc.). • To help prevent fire and explosion: <ul style="list-style-type: none"> • Do not install equipment approved only for a non-hazardous location in a hazardous location. See model ID label for the intrinsic safety rating of your model. • Do not substitute system components as this may impair intrinsic safety. • Equipment that comes in contact with the intrinsically safe terminals must be rated for Intrinsic Safety. This includes DC voltage meters, ohmmeters, cables, and connections. Remove the unit from the hazardous area when troubleshooting.
    	<p>SKIN INJECTION HAZARD</p> <p>High-pressure fluid from gun, hose leaks, or ruptured components will pierce skin. This may look like just a cut, but it is a serious injury that can result in amputation. Get immediate surgical treatment.</p> <ul style="list-style-type: none"> • Do not spray without tip guard and trigger guard installed. • Engage trigger lock when not spraying. • Do not point gun at anyone or at any part of the body. • Do not put your hand over the spray tip. • Do not stop or deflect leaks with your hand, body, glove, or rag. • Follow the Pressure Relief Procedure when you stop spraying/dispensing and before cleaning, checking, or servicing equipment. • Tighten all fluid connections before operating the equipment. • Check hoses and couplings daily. Replace worn or damaged parts immediately.
 	<p>MOVING PARTS HAZARD</p> <p>Moving parts can pinch, cut or amputate fingers and other body parts.</p> <ul style="list-style-type: none"> • Keep clear of moving parts. • Do not operate equipment with protective guards or covers removed. • Pressurized equipment can start without warning. Before checking, moving, or servicing equipment, follow the Pressure Relief Procedure and disconnect all power sources.

 <h1 style="margin: 0;">WARNING</h1>	
 	<p>TOXIC FLUID OR FUMES Toxic fluids or fumes can cause serious injury or death if splashed in the eyes or on skin, inhaled, or swallowed.</p> <ul style="list-style-type: none"> • Read Safety Data Sheet (SDS) for handling instructions and to know the specific hazards of the fluids you are using, including the effects of long-term exposure. • When spraying, servicing equipment, or when in the work area, always keep work area well ventilated and always wear appropriate personal protective equipment. See Personal Protective Equipment warnings in this manual. • Store hazardous fluid in approved containers, and dispose of it according to applicable guidelines.
	<p>PERSONAL PROTECTIVE EQUIPMENT Always wear appropriate personal protective equipment and cover all skin when spraying, servicing equipment, or when in the work area. Protective equipment helps prevent serious injury, including long-term exposure; inhalation of toxic fumes, mists, or vapors; allergic reactions; burns; eye injury and hearing loss. This protective equipment includes, but is not limited to:</p> <ul style="list-style-type: none"> • A properly fitting respirator, which may include a supplied-air respirator, chemically impermeable gloves, protective clothing and foot coverings as recommended by the fluid manufacturer and local regulatory authority. • Protective eyewear, and hearing protection.
  	<p>EQUIPMENT MISUSE HAZARD Misuse can cause death or serious injury.</p> <ul style="list-style-type: none"> • Do not operate the unit when fatigued or under the influence of drugs or alcohol. • Do not exceed the maximum working pressure or temperature rating of the lowest rated system component. See Technical Data in all equipment manuals. • Use fluids and solvents that are compatible with equipment wetted parts. See Technical Data in all equipment manuals. Read fluid and solvent manufacturer's warnings. For complete information about your material, request MSDS from distributor or retailer. • Do not leave the work area while equipment is energized or under pressure. • Turn off all equipment and follow the Pressure Relief Procedure when equipment is not in use. • Check equipment daily. Repair or replace worn or damaged parts immediately with genuine manufacturer's replacement parts only. • Do not alter or modify equipment. Alterations or modifications may void agency approvals and create safety hazards. • Make sure all equipment is rated and approved for the environment in which you are using it. • Use equipment only for its intended purpose. Call your distributor for information. • Route hoses and cables away from traffic areas, sharp edges, moving parts, and hot surfaces. • Do not kink or over bend hoses or use hoses to pull equipment. • Keep children and animals away from work area. • Comply with all applicable safety regulations.

Important Isocyanate (ISO) Information

Isocyanates (ISO) are catalysts used in two component materials.



Isocyanate Conditions

				
-----------------------------------------------------------------------------------	-----------------------------------------------------------------------------------	-----------------------------------------------------------------------------------	-----------------------------------------------------------------------------------	--

Spraying or dispensing fluids that contain isocyanates creates potentially harmful mists, vapors, and atomized particulates



- Read and understand the fluid manufacturer's warnings and Safety Data Sheet (SDS) to know specific hazards and precautions related to isocyanates.
- Use of isocyanates involves potentially hazardous procedures. Do not spray with the equipment unless you are trained, qualified, and have read and understood the information in this manual and in the fluid manufacturer's application instructions and SDS.
- Use of incorrectly maintained or mis-adjusted equipment may result in improperly cured material. Equipment must be carefully maintained and adjusted according to instructions in the manual.
- To prevent inhalation of isocyanate mists, vapors, and atomized particulates, everyone in the work area must wear appropriate respiratory protection. Always wear a properly fitting respirator, which may include a supplied-air respirator. Ventilate the work area according to instructions in the fluid manufacturer's SDS.
- Avoid all skin contact with isocyanates. Everyone in the work area must wear chemically impermeable gloves, protective clothing and foot coverings as recommended by the fluid manufacturer and local regulatory authority. Follow all fluid manufacturer recommendations, including those regarding handling of contaminated clothing. After spraying, wash hands and face before eating or drinking.

Material Self-ignition

				
-----------------------------------------------------------------------------------	------------------------------------------------------------------------------------	--	--	--

Some materials may become self-igniting if applied too thick. Read material manufacturer's warnings and Safety Data Sheet (SDS).

Keep Components A and B Separate

				
-----------------------------------------------------------------------------------	------------------------------------------------------------------------------------	-------------------------------------------------------------------------------------	--	--

Cross-contamination can result in cured material in fluid lines which could cause serious injury or damage equipment. To prevent cross-contamination:

- **Never** interchange component A and component B wetted parts.
- Never use solvent on one side if it has been contaminated from the other side.

Moisture Sensitivity of Isocyanates

Exposure to moisture (such as humidity) will cause ISO to partially cure; forming small, hard, abrasive crystals, which become suspended in the fluid. Eventually a film will form on the surface and the ISO will begin to gel, increasing in viscosity.

NOTICE

Partially cured ISO will reduce performance and the life of all wetted parts.

- Always use a sealed container with a desiccant dryer in the vent, or a nitrogen atmosphere. **Never** store ISO in an open container.
- Keep the ISO pump wet cup or reservoir (if installed) filled with appropriate lubricant. The lubricant creates a barrier between the ISO and the atmosphere.
- Use only moisture-proof hoses compatible with ISO.
- Never use reclaimed solvents, which may contain moisture. Always keep solvent containers closed when not in use.
- Always lubricate threaded parts with an appropriate lubricant when reassembling.

NOTE: The amount of film formation and rate of crystallization varies depending on the blend of ISO, the humidity, and the temperature.

Changing Materials

NOTICE







Changing the material types used in your equipment requires special attention to avoid equipment damage and downtime.

- When changing materials, flush the equipment multiple times to ensure it is thoroughly clean.
- Always clean the fluid inlet strainers after flushing.
- Check with your material manufacturer for chemical compatibility.
- When changing between epoxies and urethanes or polyureas, disassemble and clean all fluid components and change hoses. Epoxies often have amines on the B (hardener) side. Polyureas often have amines on the A (resin) side.

Important Acid Catalyst Information

The PD2K MC3000 and MC4000 Proportioner is designed for acid catalysts (“acid”) currently used in two-component, wood-finishing materials. Current acids in use (with pH levels as low as 1) are more corrosive than earlier acids. More corrosion-resistant wetted materials of construction are required, and must be used without substitution, to withstand the increased corrosive properties of these acids.

Acid Catalyst Conditions

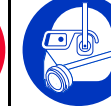
									
<p>Acid is flammable, and spraying or dispensing acid creates potentially harmful mists, vapors, and atomized particulates. To help prevent fire and explosion and serious injury:</p> <ul style="list-style-type: none">• Read and understand the acid manufacturer’s warnings and Safety Data Sheet (SDS) to know specific hazards and precautions related to the acid.• Use only genuine, manufacturer’s recommended acid-compatible parts in the catalyst system (hoses, fittings, etc). A reaction may occur between any substituted parts and the acid.• To prevent inhalation of acid mists, vapors, and atomized particulates, everyone in the work area must wear appropriate respiratory protection. Always wear a properly fitting respirator, which may include a supplied-air respirator. Ventilate the work area according to instructions in the acid manufacturer’s SDS.• Avoid all skin contact with acid. Everyone in the work area must wear chemically impermeable gloves, protective clothing, foot coverings, aprons, and face shields as recommended by the acid manufacturer and local regulatory authority. Follow all acid manufacturer recommendations, including those regarding handling of contaminated clothing. Wash hands and face before eating or drinking.• Regularly inspect equipment for potential leaks and remove spills promptly and completely to avoid direct contact or inhalation of the acid and its vapors.• Keep acid away from heat, sparks, and open flames. Do not smoke in the work area. Eliminate all ignition sources.• Store acid in the original container in a cool, dry, and well-ventilated area away from direct sunlight and away from other chemicals in accordance with acid manufacturer’s recommendations. To avoid corrosion of containers, do not store acid in substitute containers. Reseal the original container to prevent vapors from contaminating the storage space and surrounding facility.									

Moisture Sensitivity of Acid Catalysts

Acid catalysts can be sensitive to atmospheric moisture and other contaminants. It is recommended the catalyst pump and valve seal areas exposed to atmosphere are flooded with ISO oil, TSL, or other compatible material to prevent acid build-up and premature seal damage and failure.

NOTICE

Acid build-up will damage the valve seals and reduce the performance and life of the catalyst pump. To prevent exposing acid to moisture:

- Always use a sealed container with a desiccant dryer in the vent, or a nitrogen atmosphere. Never store acids in an open container.
- Keep the catalyst pump and the valve seals filled with the appropriate lubricant. The lubricant creates a barrier between the acid and the atmosphere.
- Use only moisture-proof hoses compatible with acids.
- Always lubricate threaded parts with an appropriate lubricant when reassembling.

Glossary of Terms

Advanced Display Module (ADM) - the user interface for the system. See [Advanced Display Module, page 17](#).

Enhanced Fluid Control Module (EFCM) - the fluid controller for the system.

Grand Total - a non-resettable value that shows the total amount of material dispensed through the system.

Idle - if the gun is not triggered for a user-settable value, the system enters Idle mode. Trigger the gun to resume operation.

Intrinsically Safe (IS) - refers to the ability to locate certain components in a hazardous location.

Job Total - a resettable value that shows the amount of material dispensed through the system for one job. A job is complete when the user presses the Job Complete key on the Booth Control or ADM.

Mix - when cross-linking of the resin (A) and catalyst (B) occurs.

Potlife Time - the amount of time before a material becomes unsprayable.

Potlife Volume - the amount of material that is required to move through the mix manifold, hose, and applicator before the potlife timer is reset.

Pump Calibration Factor - the amount of material dispensed per revolution of the motor.

Purge - when all mixed material is flushed from the mix manifold, hose, and gun.

Purge Time - the amount of time required to flush all mixed material from the gun.

Run Screens - The Run screens provide a graphical depiction of system operation and current status. See [Run Mode Screens, page 32](#).

Setup Screens - The Setup screens allow the user to define the system, setup recipes, and establish system operating parameters. See [Setup Mode Screens, page 39](#).

Standby - refers to the status of the system.

Overview

Usage

This electronic two-component paint proportioner can blend most two-component paints, including quick-setting paints (those with a pot life of 5 minutes and greater).

- The system dispenses Material A, monitors fluid flow, and continually dispenses Material B at ratio.
- Can proportion at ratios from 0.1:1 to 50.0:1 (depending on material, flow rate, pump size selection, and mix point).
- Will display the last 200 jobs, 200 errors, and 200 events with date, time, and description.

Component Identification and Definition

Component	Description
Electrical Control Box	<ul style="list-style-type: none"> • Enhanced Fluid Control Module (EFCM) • 24 V Power Supply for the barrier board and the EFCM • 48 V Power Supply for pump motors • Solenoid Valves for solvent valve and gun flush box (if present) • Air Flow Switch • Relay • Optional Pressure Switch for gun flush box (if present) • Pump Control Modules (2), one for each pump • CAN Isolation Board • Intrinsically Safe Power Barrier Board
Fluid Components	<ul style="list-style-type: none"> • Mix manifold (accessory), which can be attached to the operator's belt. • Color/catalyst valve stacks, including pneumatically operated valves for Material A and B, as well as solvent valves. • Solvent Flow Switch • Pumps • Pressure transducers
Advanced Display Module	Use to set up, display, operate, and monitor the system. Use for daily painting functions including choosing recipes, reading/clearing errors, and placing the system in Spray, Standby, or Purge mode. Locate in the non-hazardous area.
Booth Control	Use for daily painting functions including choosing recipes, reading/clearing errors, and placing the system in Spray, Standby, or Purge mode. Locate in the hazardous area.

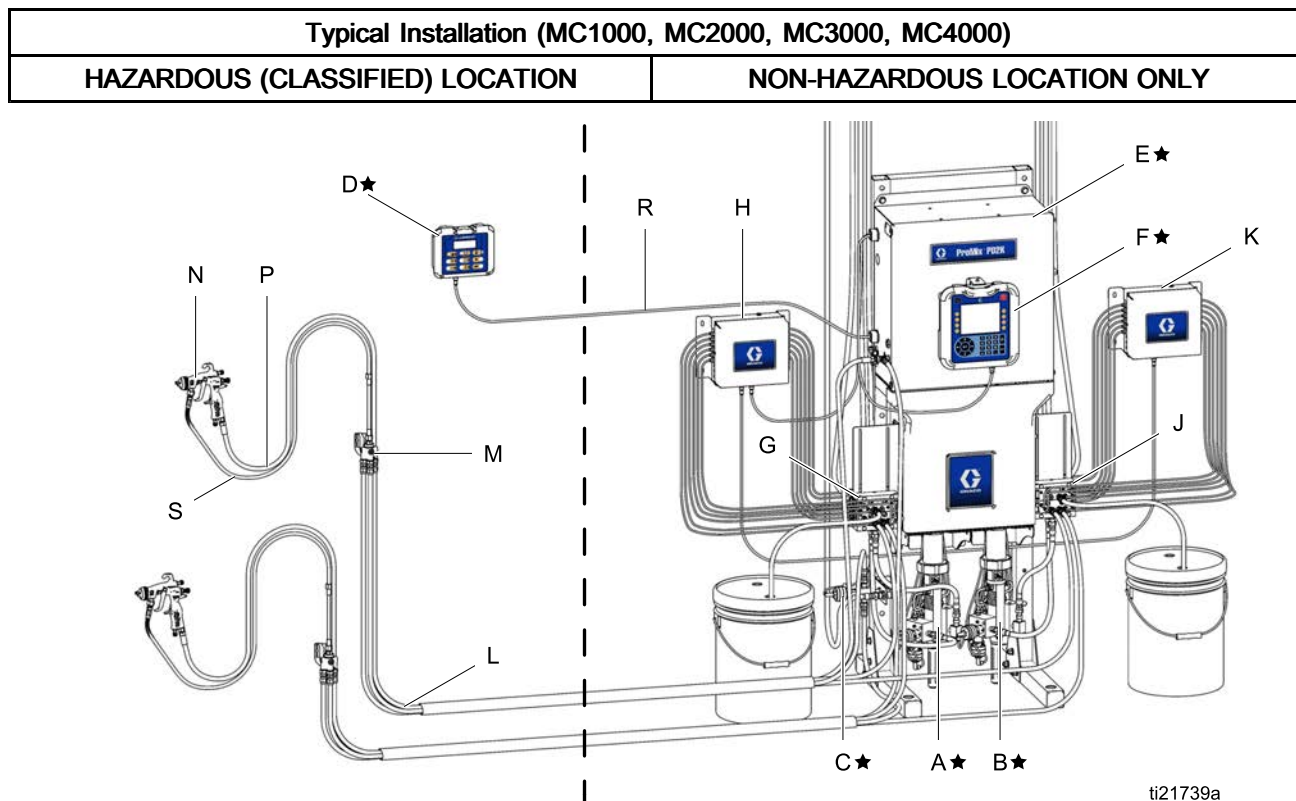
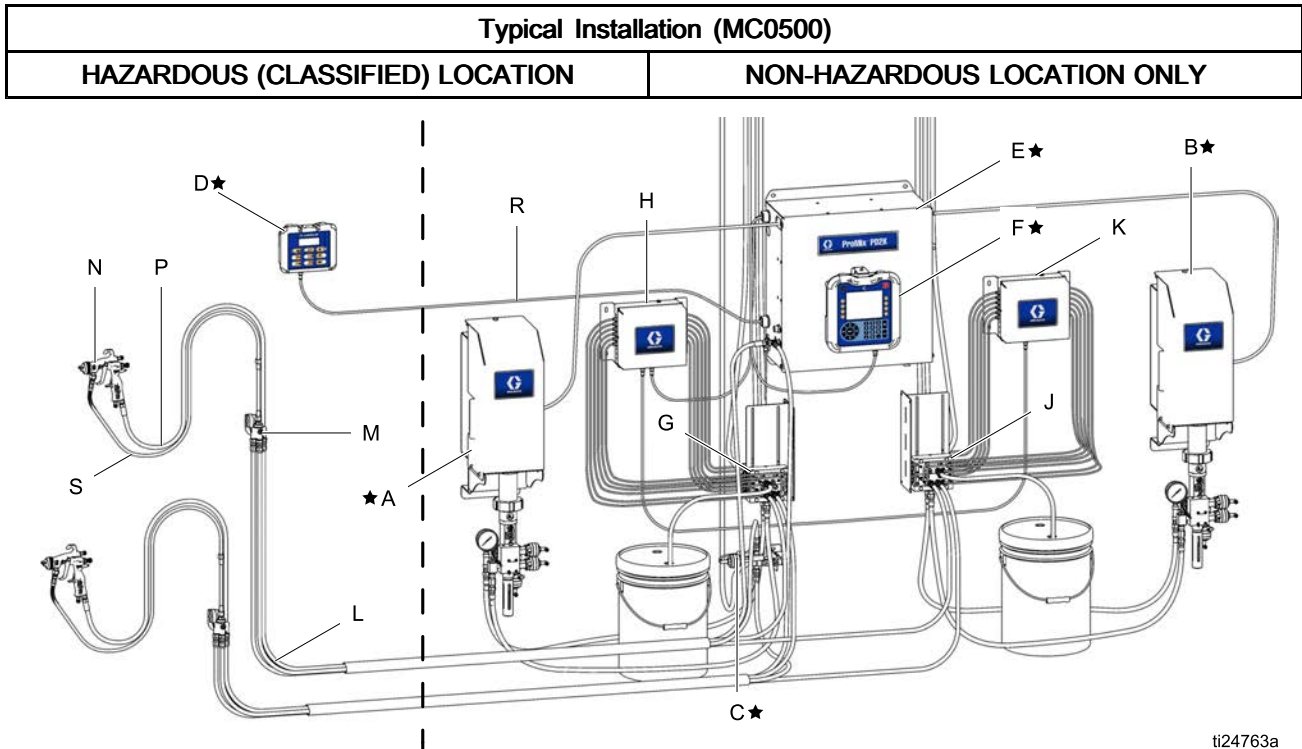

Figure 8

Component	Description
★ Components A through F are included with the base unit.	
A★	Material A (Color) Pump
B★	Material B (Catalyst) Pump
C★	Solvent Valve
D★	Booth Control
E★	Electrical Control Box
F★	Advanced Display Module

Component	Description
Components G through K are included in optional color change kits.	
G	Color Change Valves (accessory)
H	Color Change Module (accessory)
J	Catalyst Change Valves (accessory)
K	Catalyst Change Module (accessory)

Component	Description
Components L through S are accessories and must be ordered separately.	
L	Fluid/Air Hose Bundle (accessory) — see PD2K Installation Manual (332457) for acid-compatible hose bundles
M	Mix Manifold (accessory) — see Mix Manifold Instruction-Parts Manual (3A2801) for acid-compatible mix manifolds
N	Air Spray Gun (accessory)
P	Gun Air Hose (accessory)
R	Intrinsically Safe CAN Cable (to connect booth control to electrical control box)
S	Gun Fluid Hose (accessory)



ti24763a

Figure 9

Component	Description
★ Pumps A and B are required but are sold separately for system design flexibility.	
A★	Material A (Color) Pump
B★	Material B (Catalyst) Pump

Component	Description
★ Components D, E, and F are included with the base unit.	
D★	Booth Control
E★	Electrical Control Box
F★	Advanced Display Module

Component	Description
Components G through K are included in optional color change kits.	
G	Color Change Valves (accessory)
H	Color Change Module (accessory)

Component	Description
J	Catalyst Change Valves (accessory)
K	Catalyst Change Module (accessory)
Components L through S are accessories and must be ordered separately.	
L	Fluid/Air Hose Bundle (accessory) — see PD2K Installation Manual (332457) for acid-compatible hose bundles
M	Mix Manifold (accessory) — see Mix Manifold Instruction-Parts Manual (3A2801) for acid-compatible mix manifolds
N	Air Spray Gun (accessory)
P	Gun Air Hose (accessory)
R	Intrinsically Safe CAN Cable (to connect booth control to electrical control box)
S	Gun Fluid Hose (accessory)

Advanced Display Module

ADM Display

The ADM display shows graphical and text information related to setup and spray operations.

For detail on the display and individual screens, see [Run Mode Screens, page 32](#), or [Setup Mode Screens, page 39](#).

Keys are used to input numerical data, enter setup screens, navigate within a screen, scroll through screens, and select setup values.

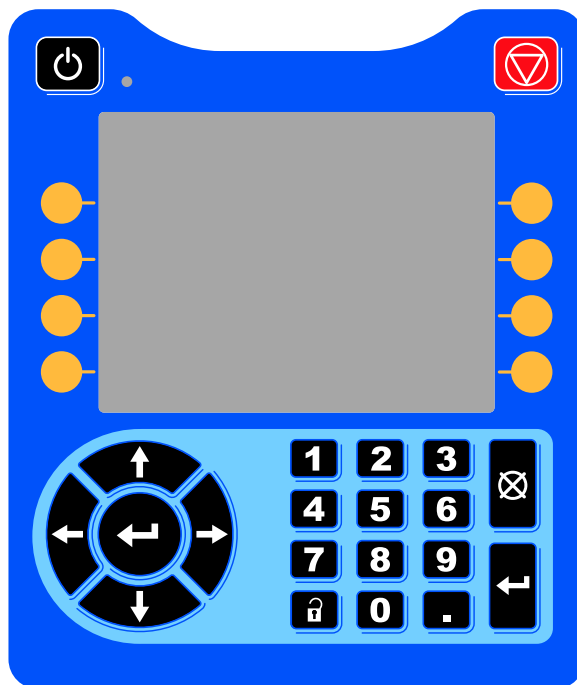
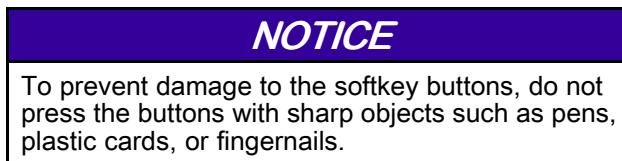

Figure 10 Advanced Display Module

USB Download Procedure

Use the USB port on the ADM to download or upload data.

1. Enable USB downloads. See [Advanced Screen 3, page 69](#).
2. Remove the cover from the USB port on the bottom of the ADM. Insert the USB drive.
3. During the download, USB BUSY appears on the screen.
4. When the download is complete, USB IDLE appears on the screen. The USB drive may then be removed.

NOTE: If the download operation takes longer than 60 seconds, the message disappears. To determine if the USB is busy or idle, check the Error Status bar on the screen. If idle, remove the USB.

5. Insert the USB flash drive into the USB port of the computer.
6. The USB flash drive window automatically opens. If it does not, open the USB flash drive from within Windows® Explorer.
7. Open Graco folder.
8. Open system folder. If downloading data from more than one system, there will be more than one folder. Each folder is labeled with the corresponding serial number of the ADM. (The serial number is on the back of the ADM.)
9. Open DOWNLOAD folder.
10. Open LOG FILES folder labeled with the highest number. The highest number indicates the most recent data download.
11. Open log file. Log files open in Microsoft® Excel® by default if the program is installed. They also can be opened in any text editor of Microsoft® Word.

NOTE: All USB logs are saved in Unicode (UTF-16) format. If opening the log file in Microsoft Word, select Unicode encoding.

12. Always reinstall the USB cover after removing the USB, to keep the drive free of dirt and dust.

USB Upload Procedure

Use this procedure to install a system configuration file and/or a custom language file.

1. If necessary, follow the **USB Download Procedure**, to automatically generate the proper folder structure on the USB flash drive.
2. Insert the USB flash drive into the USB port of the computer.
3. The USB flash drive window automatically opens. If it does not, open the USB flash drive from within Windows Explorer.
4. Open the Graco folder.
5. Open the system folder. If working with more than one system, there will be more than one folder within the Graco folder. Each folder is labeled with the corresponding serial number of the ADM. (The serial number is on the back of the module.)
6. If installing the system configuration settings file, place SETTINGS.TXT file into UPLOAD folder.

7. If installing the custom language file, place DISPTXT.TXT file into UPLOAD folder.
8. Remove the USB flash drive from the computer.
9. Install the USB flash drive into the USB port of the ProMix PD2K system USB port.
10. During the upload, USB BUSY displays on the screen.
11. Remove the USB flash drive from the USB port.

NOTE: If the custom language file was installed, users can now select the new language from the Language drop-down menu in the Advanced Setup Screen 1.







NOTE: If the system configuration settings file was installed, it is recommended to remove this file from the UPLOAD folder on the USB flash drive. This will prevent inadvertently overwriting any future setup changes.

ADM Keys and Indicators

NOTICE

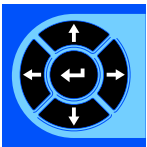
To prevent damage to the softkey buttons, do not press the buttons with sharp objects such as pens, plastic cards, or fingernails.

Table 1 : ADM Keys and Indicators

Key	Function
 <p>Startup/Shutdown Key and Indicator</p>	<p>Press to startup or shutdown the pump/motor.</p> <ul style="list-style-type: none"> • Solid green indicates that power is applied to the motor. • Solid yellow indicates that power to the motor is off. • Blinking green or yellow indicates that the system is in Setup mode.
 <p>Stop</p>	<p>Press to immediately stop the system and remove motor power.</p>
 <p>Soft Keys</p>	<p>Press to select the specific screen or operation shown on the display directly next to each key. The top left soft key is the Edit key, which allows access to any settable fields on a screen.</p>
 <p>Navigation Keys</p>	<ul style="list-style-type: none"> • <i>Left/Right Arrows:</i> Use to move from screen to screen. • <i>Up/Down Arrows:</i> Use to move among fields on a screen, items on a dropdown menu, or multiple screens within a function.
<p>Numeric Keypad</p>	<p>Use to input values. See ADM Display, page 17.</p>
 <p>Cancel</p>	<p>Use to cancel a data entry field.</p>
 <p>Setup</p>	<p>Press to enter or exit Setup mode.</p>
 <p>Enter</p>	<p>Press to choose a field to update, to make a selection, to save a selection or value, to enter a screen, or to acknowledge an event.</p>

Soft Key Icons





The following icons appear in the ADM display, directly to the left or right of the soft key which activates that operation.

NOTICE
To prevent damage to the softkey buttons, do not press the buttons with sharp objects such as pens, plastic cards, or fingernails.

Table 2 : Soft Key Functions

Key	Function
 Enter Screen	Press to enter screen for editing. Highlights editable data on a screen. Use Up/Down arrows to move between data fields on the screen.
 Exit Screen	Press to exit screen after editing.
 Accept	Press to accept calibration value.
 Cancel	Press to cancel or reject calibration value.
 Prime Pump	Press to start a pump priming procedure.
 Line/Fill/Run	Press to start a line fill procedure.
 Pre-Fill Pump	Press to mark pump as filled. (Only for applicable pumps.)
 Mix	Press to start a spray procedure.

Key	Function
 Purge	Press to start a gun purge procedure.
 Standby	Press to stop all pumps and put system in Standby.
 Stop	
 Pressure Check	Press to start a pump pressure check.
 Volume Check	Press to start a pump volume check.
 Job Complete	Press to log the material usage and increment the job number.
 Counter Reset	Press to reset the current usage counter.
 Move Cursor to Left	Appears on the User ID Keyboard screen. Use to move cursor to the left.
 Move Cursor to Right	Appears on the User ID Keyboard screen. Use to move cursor to the right.
 Erase All	Appears on the User ID Keyboard screen. Use to erase all characters.
 Backspace	Appears on the User ID Keyboard screen. Use to erase one character at a time.

Key	Function
 Upper Case/Lower Case	Appears on the User ID Keyboard screen. Use to change case (upper/lower).
 Info	Press to get more information on active system error.
 Troubleshoot	Press to see troubleshooting information for system error.
 QR Code	Press to see QR Code for system error.

Navigating the Screens

There are two sets of screens:

- The Run screens control mixing operations and display system status and data.
- The Setup screens control system parameters and advanced features.

Press  on any Run screen to enter the Setup screens. If the system has a password lock, the Password screen displays. If the system is not locked (password is set to 0000), System Screen 1 displays.

Press  on any Setup screen to return to the Home screen.















Press the Enter soft key  to activate the editing function on any screen.

Press the Exit soft key  to exit any screen.

Use the other softkeys to select the function adjacent to them.

Screen Icons

As you move through the screens, you will notice that icons are used frequently to simplify global communication. The following descriptions explain what each icon represents.

Screen Icons	
 User ID	 Job Number
 Potlife	1:1 Target Ratio
 Recipe Number	 Flow Rate
 Pressure	 Volume
 Material A	 Material B
 Material A+B	 Solvent
 Calendar	 Time
 Alarm/Advisory	 Deviation

Booth Control

Booth Control Display

The booth control is the main control device used by the operator for daily painting functions including: changing recipes, signaling job complete, reading/clearing alarms, and placing the system in Standby, Mix, or Purge mode. It is typically mounted inside the booth or near the painter.



The booth control displays the recipe in the following formats:

- R-xx (active recipe)
- P-xx (recipe loaded in the pumps)
- G-xx (recipe loaded in the gun)

The booth control display circulates through the recipe and error status:

- Displays the recipe number (R-xx) when ready to spray (the pumps and gun are loaded with the same recipe). If the display is on steady and does not show recipe 0 or 61, the system is ready to spray. (Recipe 61 indicates an unknown material.)
- If the gun is loaded with one recipe (G-xx) and the pumps with another (P-xx), the display will alternate between the two recipes.
- If an alarm occurs, the alarm code is displayed and the red Alarm indicator will flash until acknowledged. After the alarm is acknowledged, the LED will be on steady and the recipe number will alternate with the code.
- For systems with multiple guns enabled, the active gun (AG-x) is identified.

Press and hold the Standby key  for 2 seconds to turn the pumps on or off.

To select a new recipe, scroll Up  or Down  to the desired recipe, then press Enter . If Enter is not pressed within 5 seconds, the system will revert to the existing recipe.

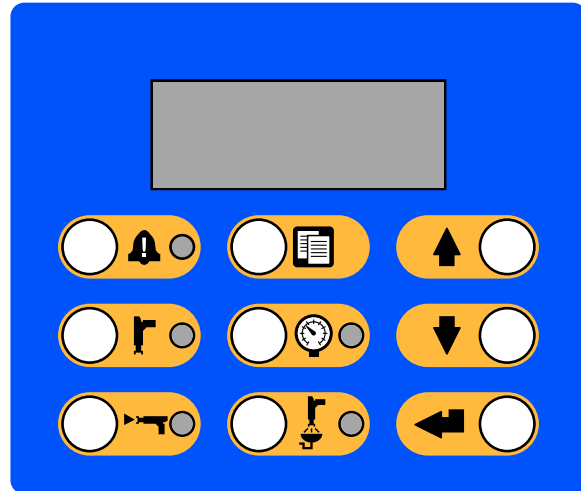











Figure 11 Booth Control

Booth Control Keys and Indicators

Key/Indicator	Definition and Function
 <p>Alarm Reset Key and Indicator</p>	<ul style="list-style-type: none"> Red LED is solid when an alarm condition is present. Red LED blinks when an event requiring user acknowledgement occurs at any level. Press key to acknowledge. LED shuts off after alarm is cleared.
 <p>Standby Mode Key and Indicator</p>	<ul style="list-style-type: none"> Starts Standby mode. Green LED remains lit while in Standby mode. Green LED blinks when the system is on and is not mixing or purging. In Idle mode, the Standby LED and the Mix LED both blink. Green LED blinks during pump maintenance checks. Press and hold the key to startup or shutdown the pumps.
 <p>Mix Mode Key and Indicator</p>	<ul style="list-style-type: none"> Starts Mix mode. Green LED remains lit while in Mix mode. Green LED blinks during a mix fill. If there is no fluid flow for 30 sec after starting mix fill, the process must be restarted. In Idle mode, the Mix LED and the Standby LED both blink.
 <p>Job Complete Key</p>	<ul style="list-style-type: none"> Signals that job is complete, and resets A, B, and solvent totalizers. Press to display the current job number on the booth control. Press a second time to log the current job and increment to the next job number. Times out after 5 seconds of inactivity.
 <p>Pressure Control Key and Indicator</p>	<ul style="list-style-type: none"> Starts Pressure Change mode. Green LED blinks while in Pressure Change mode. To change the pressure, press the Pressure Control key and use the Up/Down keys to select the desired pressure. Pressure Change mode times out after 5 seconds of inactivity. Stored recipe is only updated at the end of a spray mode.
 <p>Purge Mode Key and Indicator</p>	<ul style="list-style-type: none"> Starts Purge mode. Green LED remains lit while in Purge mode. Green LED blinks when gun needs to be purged and is waiting for purge to begin.
 <p>Up Key</p>	<ul style="list-style-type: none"> Scrolls recipe numbers up. Scrolls pressure value up in Pressure Change mode.
 <p>Down Key</p>	<ul style="list-style-type: none"> Scrolls recipe numbers down. Scrolls pressure value down in Pressure Change mode.
 <p>Enter Key</p>	<ul style="list-style-type: none"> Enters selected recipe and starts color change sequence. Accepts pressure value change.

Pre-Operation Tasks

Pre-operation Checklist

Go through the Pre-Operation Checklist daily, before each use.

✓	Checklist
	<p>System grounded</p> <p>Verify all grounding connections were made. See Grounding in the Installation manual.</p>
	<p>All connections tight and correct</p> <p>Verify all electrical, fluid, air, and system connections are tight and installed according to the Installation manual.</p>
	<p>Fluid supply containers filled</p> <p>Check component A and B and solvent supply containers.</p>
	<p>Dose valves set</p> <p>Check that dose valves are set 1–1/4 turns open. Start with the settings recommended in Valve Settings, page 25, then adjust as needed.</p>
	<p>Fluid supply valves open and pressure set</p> <p>The recommended component A and B fluid supply pressures are 1/2 to 2/3 of the target spray pressure.</p> <p>NOTE: Low pressure systems may be set within a range of ± 100 psi (0.7 MPa, 7 bar); high pressure systems may be set within a range of ± 300 psi (2.1 MPa, 21 bar). If the inlet pressure is higher than the outlet pressure, ratio accuracy may be affected.</p>
	<p>Solenoid pressure set</p> <p>85-100 psi inlet air supply (0.6-0.7 MPa, 6-7 bar).</p>

Power On

1. Turn the AC Power Switch ON (I = ON, 0 = OFF).
2. The Graco logo will display while the system initializes, followed by the Home screen.
3. Press the Start key . The system status will change from “System Off” to “Startup.” Once the pumps are powered and are in the Home position, the system status will change from “Startup” to “Standby.”

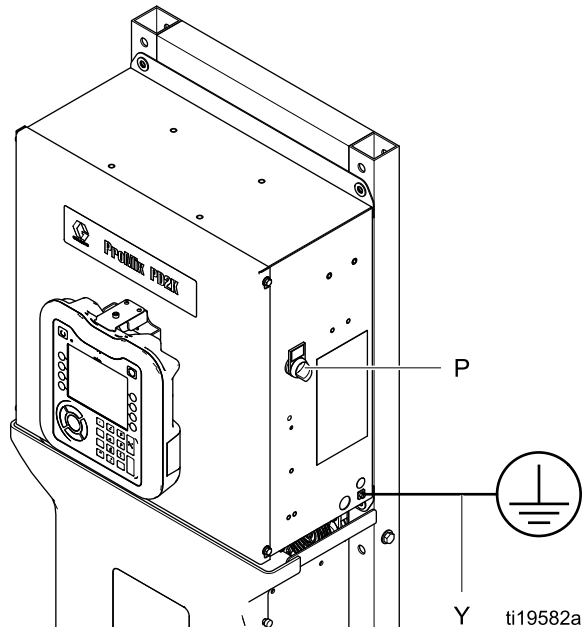

Figure 12 Power Switch

Initial System Setup

1. Change optional setup selections to desired parameters, as described in [Setup Mode Screens, page 39](#).
2. Set recipe and flush information as described in [Recipe Screen, page 50](#) and [Flush Screen, page 53](#).

Flush Before Using Equipment

The pump fluid section was tested with lightweight oil, which is left in the fluid passages to protect parts. To avoid contaminating your fluid with oil, flush the equipment with a compatible solvent before using the equipment.

Valve Settings

Dose valves and purge valves are factory set with the hex nut (E) 1-1/4 turns out from fully closed.

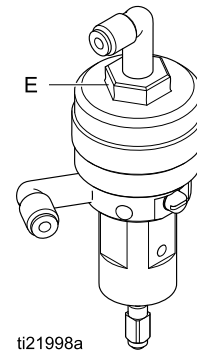

ti21998a
Figure 13 Valve Adjustment

Pressure Relief Procedure



Follow the **Pressure Relief Procedure** whenever you see this symbol.

This equipment stays pressurized until pressure is manually relieved. To help prevent serious injury from pressurized fluid, such as skin injection, splashing fluid and moving parts, follow the **Pressure Relief Procedure** when you stop spraying and before cleaning, checking, or servicing the equipment.

Without Color Change

NOTE: The following procedure relieves all fluid and air pressure in the system.

1. Turn off the supply pumps. Open the drain valve on the supply line fluid filter to relieve pressure in the supply line.

NOTE: If your system does not include a drain valve on the supply line, set the mix manifold to SPRAY and press . Cycle the A and B dosing pumps a couple of times to drain the pumps.

2. Press Standby . Trigger the gun to relieve pressure.
3. Set the mix manifold to FLUSH. Flush the mix manifold and gun. See [Flush Mixed Material, page 29](#).
4. Shut off the solvent supply pump. To relieve pressure, press Purge and trigger the gun. Press Standby when pressure is relieved, to avoid getting a Purge Incomplete alarm.

NOTE: If pressure remains in the solvent line between the solvent supply pump and the solvent valve, VERY SLOWLY loosen a fitting to relieve pressure gradually.

With Color Change

NOTE: The following procedure relieves all fluid and air pressure in the system.

1. Turn off the supply pumps. Open the drain valve on the supply line fluid filter to relieve pressure in the supply lines. Do this for each color.

NOTE: If your system does not include a drain valve on the supply line, set the mix manifold to SPRAY and press . Cycle the A and B dosing pumps a couple of times to drain the pumps. Repeat for each color.

2. If you are using a high pressure gun, engage the trigger lock. Remove the spray tip and clean it separately.

--	--	--	--	--

To help prevent fire and explosion, always shut off electrostatics before flushing.

3. If using an electrostatic gun, shut off the electrostatics before flushing the gun.
4. Set the mix manifold to SPRAY. Trigger the gun to relieve pressure. Repeat for each color.
5. Press Purge . Repeat for each color. Hold the gun trigger open after the solvent valve shuts off to relieve all pressure.
6. Set the system to Recipe 0 to flush the system from the pumps to the gun. When flushing is complete the system will go to Standby.
7. Shut off the solvent supply pump. To relieve pressure, press Purge and trigger the gun. Press Standby when pressure is relieved, to avoid getting a Purge Incomplete alarm.

NOTE: If pressure remains in the solvent line between the solvent supply pump and the solvent valve, VERY SLOWLY loosen a fitting to relieve pressure gradually.

Operation

Prime and Fill the System

NOTE: See [Run Mode Screens, page 32](#), for further screen information, if needed.



NOTE: Be sure the mix manifold is set to the SPRAY position.

NOTE: You must prime the input lines to the pumps or the inputs to the color change valves before priming the pump and filling the entire system.



1. If using an electrostatic gun, shut off the electrostatics before filling the lines.
2. Adjust the main air pressure. To ensure proper operation, set the main air pressure as close to 100 psi (0.7 MPa, 7.0 bar) as possible. Do not use less than 85 psi (0.6 MPa, 6.0 bar).
3. If this is the first time starting up the system, or if lines may contain air, purge as instructed under [Purging, page 29](#). The equipment was tested with lightweight oil, which should be flushed out to avoid contaminating your material.
4. **If the system is powered down**, press  on the ADM. Make sure that the system is in Standby mode.
5. Verify that the recipes and the flush sequences are programmed correctly by checking the [Recipe Screen, page 50](#) and the [Flush Screen, page 53](#).
6. Go to the [Fill Screen, page 36](#).

7. Select the desired color to load. Press the Prime Pump key . The color will load the pump through the color stack and out the outlet stack dump valve.

NOTE: In a single color system, skip step 7 and prime the pump out to the gun.
8. Press the Fill Line key  to run color out to the mix manifold. The pump will run until you press the Stop key  to stop the pump.
9. Trigger the gun into a grounded metal pail until the line is full, then press the Stop key .
10. Repeat for all material lines.

Pre-Fill the Pump

NOTE: This option is only available for pumps that have color change valves and only a single material.

If a pump is filled with a material when the system is powered down, this will allow the user to change the pump's contents, without flushing the pump, the next time power is restored.

1. Go to the [Fill Screen, page 36](#).
2. Press the Pre-Fill Pump key . The pump will change from material 61 to the proper color or catalyst.

Spraying

To spray in a multiple color system, also see [Multiple Color Systems, page 75](#).

NOTE: See [Run Mode Screens, page 32](#), for further screen information, if needed.

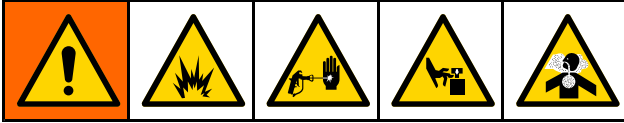

1. Set the desired mix manifold to the SPRAY position.
2. Press Mix . The system will load the correct mixed material volume. The Mix Mode LED and the recipe display on the booth control will blink during the mix fill. If the gun is loaded with one recipe (G-xx) and the pumps with another (P-xx), the display will alternate between the two recipes. When the mix fill is completed, the display will show R-xx, and the system will go into Standby Mode.

NOTE: The system will automatically run a Mix Fill if the recipe is not currently loaded into the system. The Mix Fill volume calculation includes the mix manifold volume and the mixed material hose volume. The mixed material hose volume is determined by the gun hose length and diameter entered in [System Screen 2, page 41](#).

3. Press Mix  again. The Mix Mode LED will turn on solid to indicate the system is mixing. Adjust the flow rate by changing the target pressure. The fluid flow rate shown on the Spray screen is the combined total of component A and B out of the gun.

- **If the fluid flow rate is too low:** increase the spray pressure setting on the Spray screen or booth control.
- **If the fluid flow rate is too high:** decrease the spray pressure setting on the Spray screen or booth control.

NOTE: If spray pressure is adjusted at the ADM or booth control while spraying, it is not saved in the recipe until the system is put in Standby. This changes the pressure in the desired recipe.

4. Turn on atomizing air to the gun. Check the spray pattern as instructed in your spray gun manual.

NOTE: Do not use the first 4-5 oz. (120-150 cc) of material as it may not be thoroughly mixed due to errors while priming the system. The Spray LED must be on.

NOTICE

Do not allow a fluid supply tank to run empty. This can damage the pumps and lead to the proportioning of fluid and air that meets the ratio and tolerance settings of the equipment. This can further result in spraying uncatalyzed or poorly catalyzed material.

Purging

To purge one color and fill with a new color, see [Color Change, page 75](#).

Flush Mixed Material

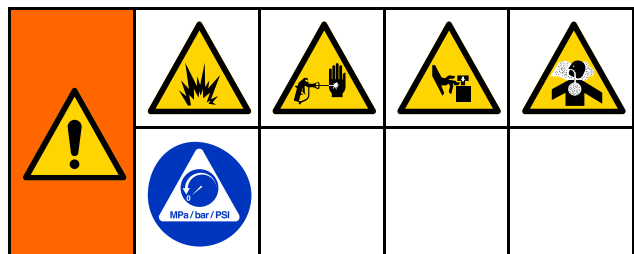

There are times when you only want to purge the mix manifold and gun, such as:

- end of potlife
- breaks in spraying that exceed the potlife
- overnight shutdown or end of shift
- before servicing the mix manifold, hose or gun.

1. Press Standby .
2. If you are using a high pressure gun or an electrostatic gun, shut off the atomizing air.
3. If you are using a high pressure gun, engage the trigger lock. Remove the spray tip and clean it separately.
4. If using an electrostatic gun, shut off the electrostatics before flushing the gun.

5. Trigger the gun to relieve pressure.
6. Set the solvent supply pressure regulator at the lowest pressure possible, to avoid splashing or an injection injury. Generally a setting of 25–50 psi (0.18–0.35 MPa, 1.8–3.5 bar) is sufficient.
7. Set the mix manifold to the FLUSH position.
8. Press Purge . Trigger the gun into a grounded metal pail until the purge sequence is complete. When done purging, the system automatically switches to Standby mode, signalling the user to release the trigger.
9. If the system is not completely clean, repeat.

NOTE: For optimal efficiency, adjust purge sequence times so only one cycle is required.
10. Trigger the gun to relieve pressure. Engage the trigger lock.
11. If the spray tip was removed, reinstall it.
12. Adjust the solvent supply regulator back to its normal operating pressure.

NOTE: The mix manifold and gun remain full of solvent after purging.

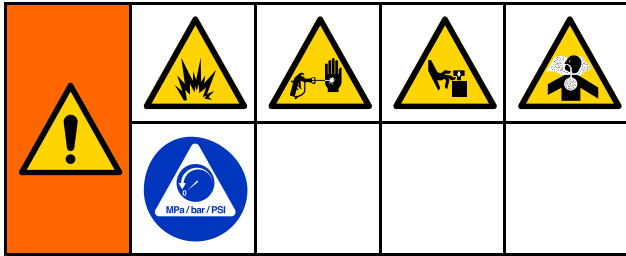

Flush the System





Follow this procedure before:

- the first time material is loaded into the equipment
- servicing
- shutting down equipment for an extended period of time
- putting equipment into storage

Single Color System

1. Relieve the pressure. See [Pressure Relief Procedure, page 26](#).
2. Disconnect the color and catalyst supply lines from the pump inlet manifolds, and connect regulated solvent supply lines.
3. Set the solvent supply pressure regulator at the lowest pressure possible, to avoid splashing or an injection injury. Generally a setting of 25–50 psi (0.18–0.35 MPa, 1.8–3.5 bar) is sufficient.
4. Set the mix manifold to the SPRAY position.
5. On the ADM, go to the Fill screen. Set the Material to Color (A). Press . The system will pump solvent through pump A all the way to the gun.
6. Hold a metal part of the gun firmly to a grounded metal pail. Trigger the gun until clean solvent dispenses.
7. On the ADM, go to the Fill screen. Set the Material to Catalyst (B). Press . The system will pump solvent through pump B all the way to the gun.
8. Relieve the pressure. See [Pressure Relief Procedure, page 26](#)

Color Change System

1. Relieve the pressure. See [Pressure Relief Procedure, page 26](#).
2. Attach regulated solvent supply lines as follows:
 - **Multiple color/single catalyst system:** On the color side, do not disconnect the color supply line from the inlet manifold of Pump A. Instead, connect a regulated solvent supply line to the designated solvent valve on the color valve manifold. On the catalyst side, disconnect the catalyst supply line from the inlet manifold of Pump B, and connect a regulated solvent supply line.
 - **Multiple color/multiple catalyst system:** Connect regulated solvent supply lines to the designated solvent valves on the color and catalyst valve manifolds. Do not connect solvent supply lines directly to the inlet manifolds of the pumps.
3. Set the solvent supply pressure regulator at the lowest pressure possible, to avoid splashing or an injection injury. Generally a setting of 25–50 psi (0.18–0.35 MPa, 1.8–3.5 bar) is sufficient.
4. Set the mix manifold to the SPRAY position.
5. On the ADM, go to the Fill screen. Select Color (A). Enter the color number in the box to the right.
6. Select the Flush Line box.
7. If the solvent is not already loaded, press the Prime softkey . The system will prime solvent into the selected pump and out the outlet dump valve.
8. Press the Fill softkey . The system will flush the selected Color (A) line with solvent until the user presses Stop .
9. Hold a metal part of the gun firmly to a grounded metal pail. Trigger the gun until clean solvent dispenses.
10. Repeat for each color line.
11. Relieve the pressure. See [Pressure Relief Procedure, page 26](#).

Shutdown

1. Flush out the mixed material to avoid potlife errors and fluid setup in the lines. See [Purging, page 29](#).
2. Follow the [Pressure Relief Procedure, page 26](#).
3. Close the main air shutoff valve on the air supply line and on the control box.
4. Press  on the Display Module to turn off power to the pumps.
5. Shut off system power (0 position).

NOTE: When pumping an acid catalyst, always flush acid from the system by completing a purge of the catalyst side of the proportioner to prevent unnecessary exposure to the acid catalyst.

Run Mode Screens

NOTE: Selection fields and buttons that are grayed-out on the screens are not currently active.

Splash Screen

At power up, the Graco logo will display for approximately 5 seconds, followed by the Home screen.



Figure 14 Splash Screen

Home Screen

The Home screen displays the current status of the system. The following table details the information shown.

To view pump flow rates and pressures (as shown), select “Diagnostic Mode” on System Screen 1, page 40.

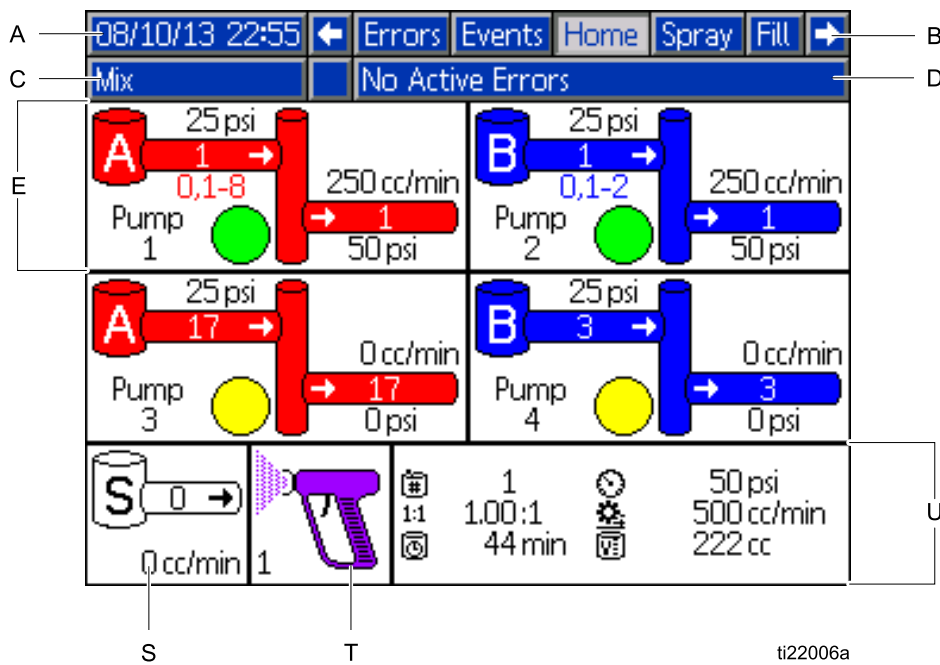

Figure 15 Home Screen, in Mix Mode with Diagnostics On

Home Screen Key

Key	Description	Details
A	Date and Time	See Advanced Screen 1, page 68 , to set.
B	Menu Bar	<p>Run Screens. Use left and right arrow keys to scroll through the different Run screens:</p> <ul style="list-style-type: none"> • Home (shown in Diagnostic Mode) • Spray (see Spray Screen, page 35) • Fill (see Fill Screen, page 36) • Potlife (present only when "Multiple Guns is selected on System Screen 3, page 43. See also Information for Systems with Multiple Guns, page 44.) • Usage (see Usage Screen, page 37) • Jobs (see Jobs Screen, page 38) • Errors (see Errors Screen, page 38) • Events (see Events Screen, page 38)
C	Status Bar	System Status: Displays the current mode of operation:
		<table border="0"> <tr> <td style="vertical-align: top;"> <ul style="list-style-type: none"> • Pump Off • Standby • Startup • Mix (Dispense for 1K Mode) • Fill • Purge • Shutdown </td> <td style="vertical-align: top;"> <ul style="list-style-type: none"> • Change Recipe • Idle • Prime Pump • Calibrate • Stall Test • Maintenance Test </td> </tr> </table>
<ul style="list-style-type: none"> • Pump Off • Standby • Startup • Mix (Dispense for 1K Mode) • Fill • Purge • Shutdown 	<ul style="list-style-type: none"> • Change Recipe • Idle • Prime Pump • Calibrate • Stall Test • Maintenance Test 	
D	Error Status	Displays any active error code.

Run Mode Screens

Key	Description	Details			
E	Pump Animation and Diagnostic Information	<p>ti22007a</p>			
F	Pump Number (1-4)				
G	Material (A or B)				
H	Available Colors				
J	Pump Inlet Color				
K	Pump Inlet Pressure				
L	Pump Flow Rate				
M	Pump Outlet Color				
N	Pump Outlet Pressure				
P	Pump Indicator Light <ul style="list-style-type: none"> • Clear = power off • Yellow = standby • Green = active 				
S	Solvent Flow Rate		Shows solvent flow rate, if a solvent meter is attached.		
T	Gun Animation		Shows mixed material in gun and displays active recipe at gun. Gun animation changes to show: <table border="1" style="width: 100%; border-collapse: collapse;"> <tbody> <tr> <td style="width: 50%; vertical-align: top;"> <ul style="list-style-type: none"> • 1 (Mix Fill) • 1 (Mix With Air Flow) • 1 (Recipe Standby) • 1 (Purge) </td> <td style="width: 50%; vertical-align: top;"> <ul style="list-style-type: none"> • 1 (Gun Purge in GFB) • 0 (Purged Gun in Standby, in GFB) • 0 (Solvent Standby) • 1 (Mix With No Air Flow) </td> </tr> </tbody> </table>	<ul style="list-style-type: none"> • 1 (Mix Fill) • 1 (Mix With Air Flow) • 1 (Recipe Standby) • 1 (Purge) 	<ul style="list-style-type: none"> • 1 (Gun Purge in GFB) • 0 (Purged Gun in Standby, in GFB) • 0 (Solvent Standby) • 1 (Mix With No Air Flow)
<ul style="list-style-type: none"> • 1 (Mix Fill) • 1 (Mix With Air Flow) • 1 (Recipe Standby) • 1 (Purge) 	<ul style="list-style-type: none"> • 1 (Gun Purge in GFB) • 0 (Purged Gun in Standby, in GFB) • 0 (Solvent Standby) • 1 (Mix With No Air Flow) 				
U	Active Recipe		<p>ti22008a</p>		
V	Current Ratio (1:1) (not shown in 1K Mode)				
W	Potlife Time Remaining				
X	Total Volume for the Current Job				
Y	Current Flow Rate				
Z	Current Pressure				

Spray Screen

The Spray screen displays the following information:

- Active Recipe (can be changed on this screen)
- Target Ratio (not shown in 1K Mode)
- Actual Ratio (not shown in 1K Mode)
- Target Pressure (can be changed on this screen)
- Actual Pressure
- Actual Flow
- Potlife Remaining
- Gun Animation

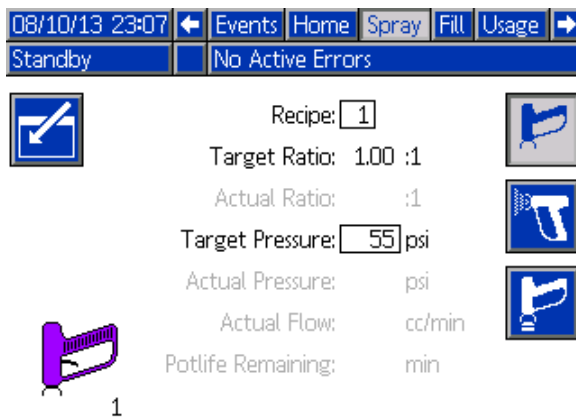

Figure 16 Spray Screen, in Standby Mode

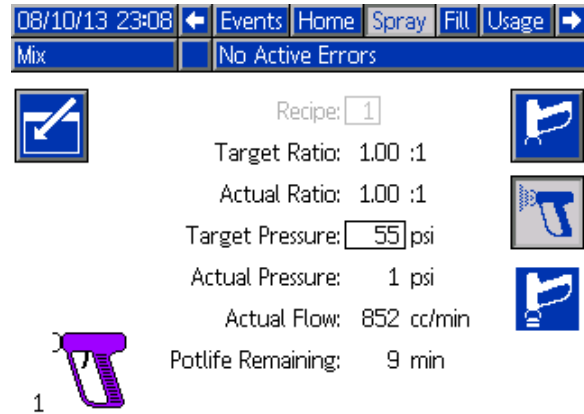

Figure 17 Spray Screen, in Mix Mode

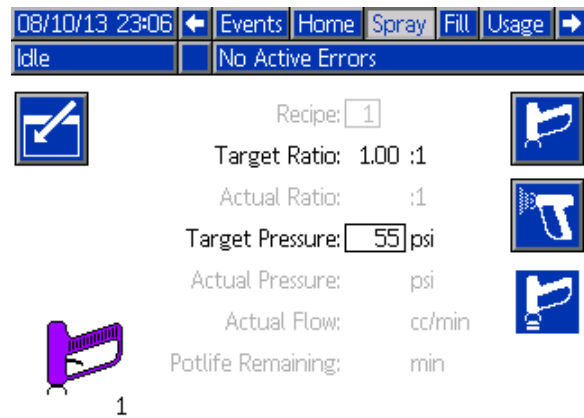



Figure 18 Spray Screen, in Idle Mode

Fill Screen



The Fill screen displays the following information for the pump assigned to the current color:

- **Material.** Select Color (A), Catalyst (B), or Solvent. The pump animation at the top of the screen will show the selected material. If solvent is selected, enter the pump number in the box to the right.
- **Flush Line** (only for systems with color change). Select this box if you want to flush the specified material line with solvent. The system uses flush sequence 1.

To prime the pumps and fill the lines, first read [Prime and Fill the System](#), page 27.



1. Press the Edit softkey  to open the screen for editing.
2. Select Color (A).
3. Enter the color number in the box to the right.
4. If the selected material is not already loaded,

press the Prime softkey . The system will prime Color (A) into the selected pump through the selected color valve and out the outlet dump valve.

5. Press the Fill softkey . The system will attempt to fill the Color (A) lines until the user presses Stop . Trigger the gun into a waste container.
6. Repeat for Catalyst (B).

To flush the system (pump and fluid lines), see [Flush the System](#), page 30.

To flush only the pump:

1. Press the Edit softkey  to open the screen for editing.
2. Select Solvent.
3. Enter the pump number in the box to the right.
4. Press the Prime softkey . The system will flush solvent through the selected pump and out the dump valve.

Pre-Fill Pump

The pump pre-fill option is available for pumps that have color change, but only a single material (color or catalyst). The pre-fill option may be used for pumps that remain filled with material when the system was powered down.

Press the Pre-Fill softkey  to “prime” the pump without flushing or expelling any material unnecessarily.

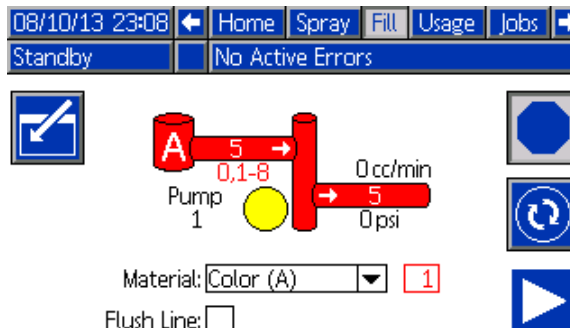

Figure 19 Fill Screen, Color (A) Selected

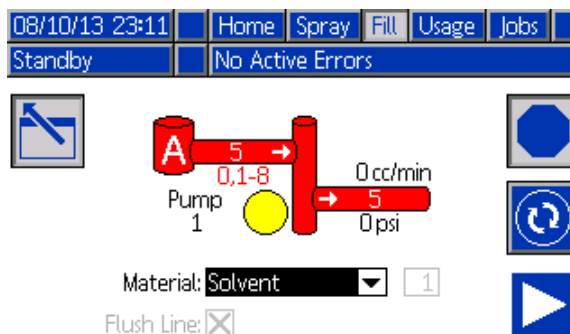

Figure 20 Fill Screen, Solvent Selected

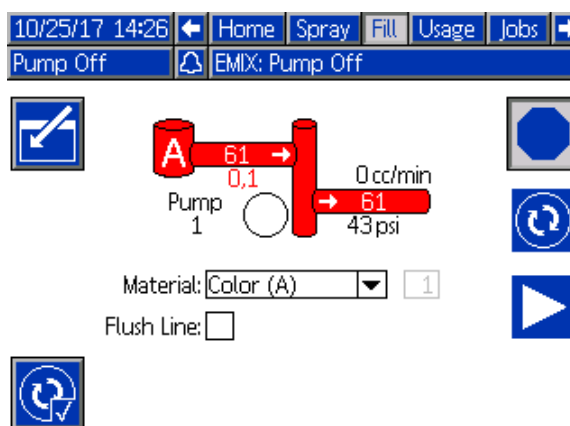





Figure 21 Fill Screen, Pre-Fill Pump Option

Usage Screen

The first Usage screen displays the current job usage and grand total usage of component A, B, A+B, and solvent (S). The second Usage screen displays the total volume pumped for all available materials.

NOTE: In 1K Mode, the B and A+B components are not shown.

1. Press the Edit softkey  to open the screen for editing.
2. To enter or change the User ID (☛), select the field to open the User ID Keyboard screen, and enter the desired name (10 characters maximum).
3. To log the current job, press the Job Complete softkey . This will clear the current usage fields and increment to the next job number. The Grand Totals cannot be cleared. See the [Jobs Screen, page 38](#), to review past jobs.
4. Press the Edit softkey  to close the screen.

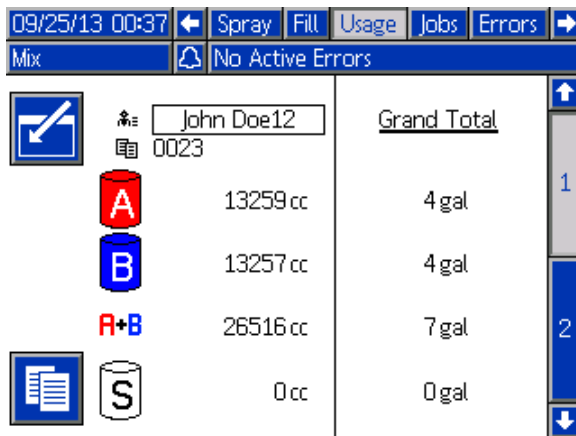

Figure 22 Usage Screen

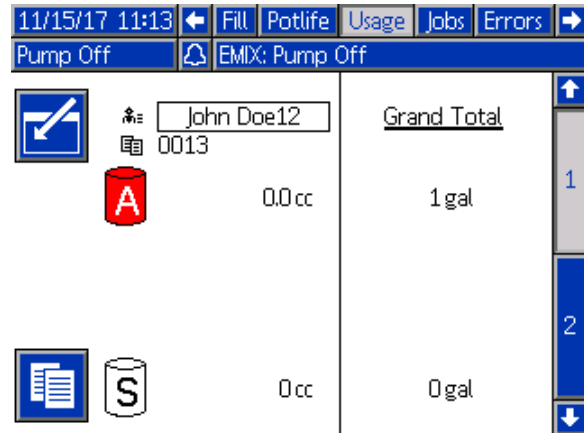

Figure 23 Usage Screen, 1K Mode

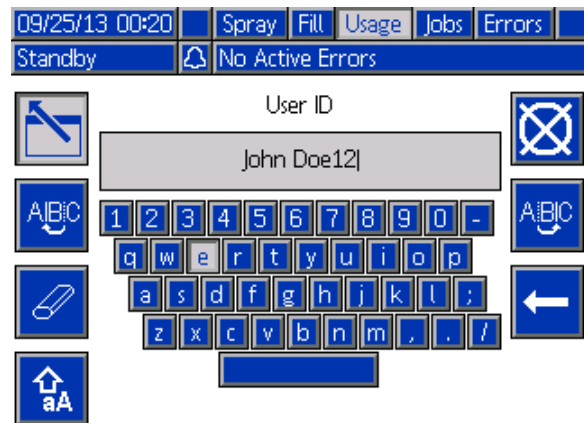

Figure 24 User ID Keyboard Screen

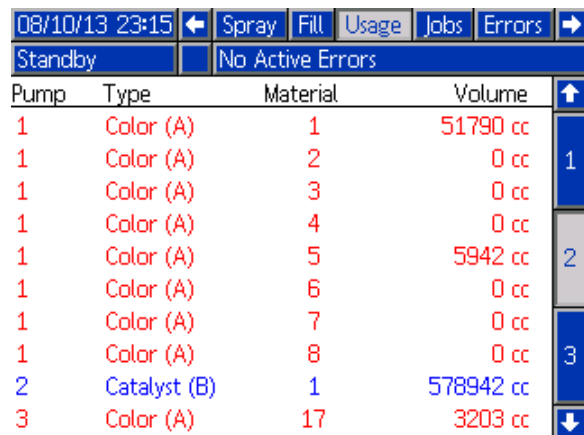

Figure 25 Usage Log

Jobs Screen

The Jobs screen displays the 200 most recent job numbers, recipes, and A+B volumes in a log, with date, time, and User ID.

09/25/13 00:24							Fill	Usage	Jobs	Errors	Events
Mix							No Active Errors				
09/25/13	00:23	John Doe12	0022	1	55 cc						
09/25/13	00:23	John Doe12	0021	1	168 cc	3					
09/25/13	00:23	John Doe12	0020	1	7 cc						
09/25/13	00:23	John Doe12	0019	1	11 cc						
09/25/13	00:23	John Doe12	0018	1	10 cc	1					
09/25/13	00:23	John Doe12	0017	1	8 cc						
09/25/13	00:23	John Doe12	0016	1	32 cc						
09/25/13	00:23	John Doe12	0015	1	184 cc	2					
09/25/13	00:23	John Doe12	0014	1	173 cc						
09/25/13	00:23	John Doe12	0013	1	219 cc						

Figure 26 Jobs Screen

Errors Screen

The Errors screen displays the 200 most recent Error Codes in a log, with date, time, and description.

08/10/13 23:17							Jobs	Errors	Events	Home	
Idle							No Active Errors				
08/10/13	22:44	DK04-A	Position Pump 4			18					
08/10/13	22:44	DK03-A	Position Pump 3			19					
08/10/13	22:44	DK02-A	Position Pump 2			20					
08/10/13	22:44	DK01-A	Position Pump 1								
08/10/13	22:44	CA0X-A	Comm. Error ADM			1					
08/10/13	22:44	P6D4-A	Press. Sens. Removed Outlet 4			2					
08/10/13	22:44	P6D3-A	Press. Sens. Removed Outlet 3			3					
08/10/13	22:44	P6D2-A	Press. Sens. Removed Outlet 2			4					
08/10/13	22:44	P6D1-A	Press. Sens. Removed Outlet 1								
08/10/13	22:44	DK04-A	Position Pump 4								

Figure 27 Errors Screen

Additional information is available for system errors to assist with troubleshooting. To access this information for a system error that has occurred,

first press the Enter  key to enter edit mode. The first error will be highlighted. Using the Up and Down arrow keys, navigate to the desired

error code, press the Enter  key again. (See [System Errors, page 76](#) for more information on the troubleshooting information screens.)

11/15/17 11:14							Jobs	Errors	Events	Home	
Pump Off							EMIX: Pump Off				
10/26/17	12:37	SPD1-A	Gun Purge Incomplete								
10/26/17	12:37	SPD1-A	Gun Purge Incomplete			1					
10/26/17	12:36	SND1-A	Mix Fill Incomplete								
10/26/17	12:35	F1S2-A	Flow Low Purge Pump 2								
10/26/17	12:33	F8D1-A	Flow Not Detected			2					
10/25/17	16:16	F7S1-A	Flow Detected Solvent Gun								
10/25/17	16:16	F7P1-A	Flow Detected Air Gun								
10/25/17	16:16	F7S1-A	Flow Detected Solvent Gun			3					
10/25/17	14:30	SND1-A	Mix Fill Incomplete								
10/25/17	14:20	P6D4-A	Press. Sens. Removed Outlet 4								

Figure 28 Errors Screen

Events Screen

The Events screen displays the 200 most recent Event Codes in a log, with date, time, and description.

08/10/13 23:17							Errors	Events	Home	Spray	
Idle							No Active Errors				
08/10/13	22:52	EC00-R	Setup Value(s) Changed			18					
08/10/13	22:51	EVUX-V	USB Disabled			19					
08/10/13	22:49	EBUX-R	USB Drive Removed			20					
08/10/13	22:48	EVUX-V	USB Disabled								
08/10/13	22:46	EBUX-R	USB Drive Removed			1					
08/10/13	22:46	EC00-R	Setup Value(s) Changed			2					
08/10/13	22:45	EQU0-V	USB Idle			3					
08/10/13	22:45	EQU1-R	Sys. Settings Downloaded			4					
08/10/13	22:45	EQU3-R	Custom Lang. Downloaded								
08/10/13	22:45	EQU5-R	Logs Downloaded								

Figure 29 Events Screen

Setup Mode Screens

Press  on any Run screen to enter the Setup screens.

NOTE: Selection fields and buttons that are grayed-out on the screens are not currently active.

If the system has a password lock, the Password screen displays. See [Password Screen, page 39](#).

Password Screen

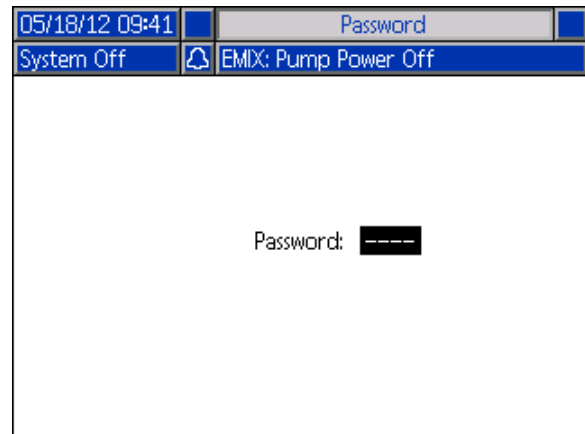



Figure 30 Password Screen

Enter the 4 digit password, then press . System screen 1 will open, allowing access to the other Setup screens.

Entering an incorrect password clears the field. Reenter the correct password.

To assign a password, see [Advanced Screen 1, page 68](#).

System Screen 1

System screen 1 includes the following fields which define your system.

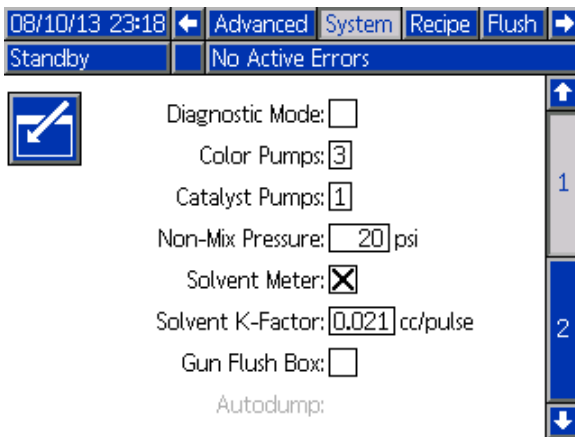

Figure 31 System Screen 1, During Standby

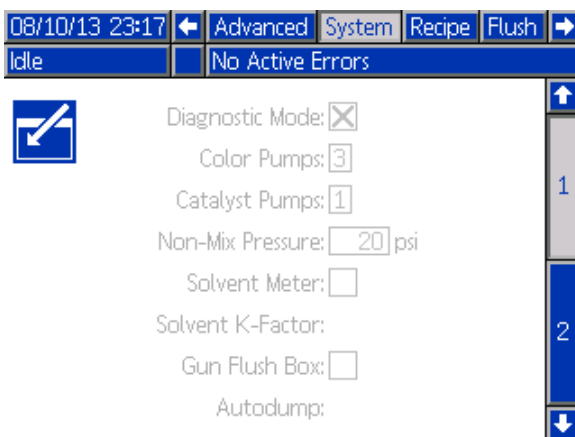

Figure 32 System Screen 1, During Idle

Diagnostic Mode

Select this box to display flow rate and pressure for each pump on the [Home Screen, page 32](#).

Color Pumps

Enter the number of color pumps in your system.

Catalyst Pumps

Enter the number of catalyst pumps in your system.

NOTE: Changing the number of catalyst pumps to “0” will put the system into 1K Mode.

Non-Mix Pressure (Fill Pressure - 1K Mode)

NOTE: Non-Mix Pressure is replaced by Fill Pressure when in 1K Mode.

Enter a lower pressure for use when not mixing and spraying (for example during fill or flushing).

NOTE: Low pressure systems may be set 100 psi (0.7 MPa, 7 bar) lower than target pressure; high pressure systems may be set 300 psi (2.1 MPa, 21 bar) lower than target pressure.

Solvent Meter

Select this box if your system uses a solvent meter. The Solvent K-Factor field will then become active.

Solvent K-Factor

Enter the solvent meter K-Factor.

Select Gun Flush Box

Select this box if your system uses a gun flush box. The Autodump function will then become selectable.

Autodump

Select this box to activate the Autodump function. If a gun is loaded with a mixed recipe that has a potlife that has expired and is placed in the Gun Flush Box, after two minutes, the system will automatically purge the gun with solvent. If the gun is not in the Gun Flush Box or the Autodump cannot complete, the system will generate an alarm.

System Screen 2

System screen 2 sets the following system operating parameters.

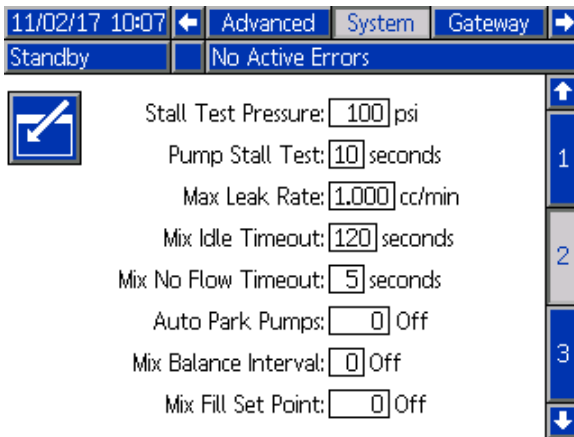

Figure 33 System Screen 2, in Standby Mode

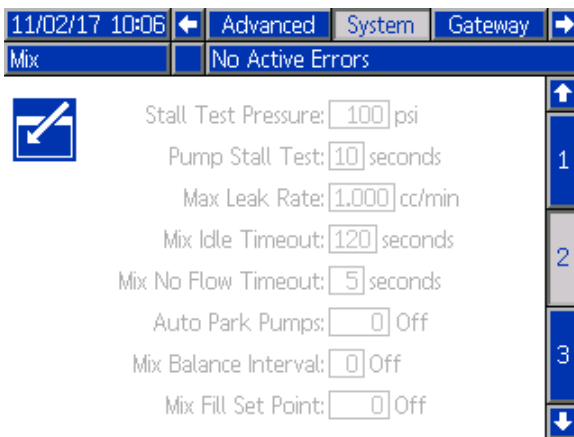

Figure 34 System Screen 2, in Mix Mode

Stall Test Pressure

Set the minimum stall test pressure. The setting should be approximately 50 psi (0.35 MPa, 3.5 bar) higher than the highest inlet pressure.

NOTE: If the material supply pressure at the pump inlet is greater than 90% of the Stall Test Pressure, the system will generate an alarm and will not complete the Stall Test. See [Calibrate Screen 1, page 63](#).

Pump Stall Test

Set the duration for the pump stall test. See [Calibrate Screen 1, page 63](#).

Maximum Leak Rate

Enter the maximum allowable leak rate for a pump stall test.

Mix Idle Timeout (Idle Timeout - 1K Mode)

The air flow switch (AFS) detects air flow to the gun and signals that the gun is triggered. If you are not using an air flow switch, the system does not know if the gun is spraying. If a pump failed you could spray pure resin or catalyst without knowing. This should be caught by the Mix No Flow Timeout; the default is 5 seconds. The Mix Idle Timeout will trigger Idle mode, which will run a pump stall test to check for leaks, then put the pumps in Standby (holding their current position) after the designated period of time. Enter the desired Mix Idle Timeout in this field.

See [Air Flow Switch \(AFS\) Function, page 77](#).

Mix No Flow Timeout (No Flow Timeout - 1K Mode)

The air flow switch (AFS) detects air flow to the gun and signals that the gun is triggered. If the air flow switch indicates that the gun is triggered, but there is no fluid flow through a pump, you could spray pure resin or catalyst without knowing. The Mix No Flow Timeout will cause the system to shutdown after the designated period of time. The default is 5 seconds. Enter the desired shutdown time in this field.

See [Air Flow Switch \(AFS\) Function, page 77](#).

Auto Park Pumps

Parking the pumps will help prevent material from hardening on the pump rods. The Auto Park Pumps timer will automatically park all pumps and turn off pump power. The default value of 0 minutes turns off this feature.

NOTE: The timer only runs while the system is in Standby and all guns are purged to prevent volumes from going off ratio.

Mix Balance Interval (not used in 1K Mode)

When transitioning from Standby mode to Mix mode, fluid viscosities and high ratios may affect how quickly fluid dynamics balance, which may result in nuisance Exceed Max Flow or Differential Pressure mixing alarms.

The Mix Balance Interval set point may be used to enable a brief period at the start of a mix cycle for fluids to balance before generating any mixing alarms.

NOTE: The Mix Balance Interval timer only runs while the gun is triggered. Setting this time to zero turns the timer off.

Mix Fill Set Point (Fill Set Point - 1K Mode)

Set a higher pressure for use while mix filling. This higher pressure decreases the time needed to fill the gun. Once the gun is filled, the system uses the recipe's target pressure setpoint (set on [Recipe Screen, page 50](#)) for mixing.

The default value is 0. When set to 0, the system ignores the Mix Fill Set Point and instead uses the recipe's target pressure setpoint (set on [Recipe Screen, page 50](#)) while mix filling.

System Screen 3

System screen 3 sets the following system operating parameters.

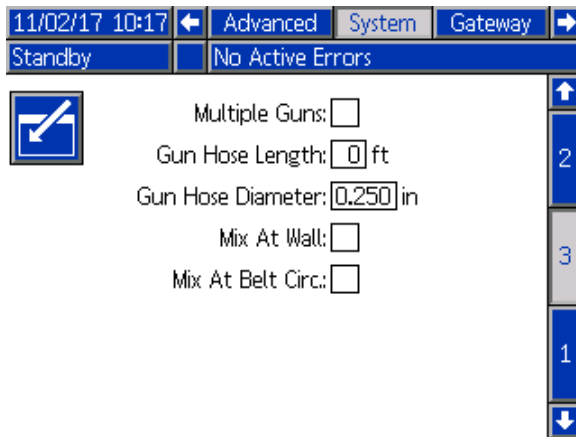

Figure 35 System Screen 3

Multiple Guns

Enable this option if multiple guns will be loaded with mixed material at the same time. See [Information for Systems with Multiple Guns, page 44](#).

NOTE: If Multiple Guns is enabled, the Gun Hose Length and Gun Hose Diameter fields are disabled.

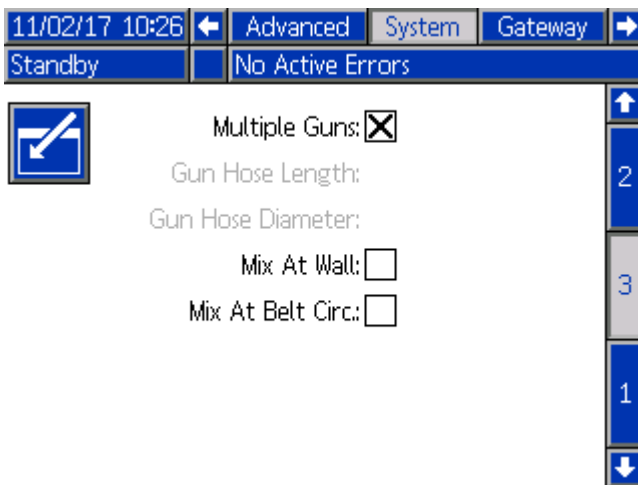

Figure 36 System Screen 3, Multiple Guns

Gun Hose Length

Enter the length of the hose from the mix manifold to the gun.

Gun Hose Diameter

Enter the diameter of the hose from the mix manifold to the gun. The minimum diameter is 1/8 in. (3 mm).

Mix At Wall

Select this box if a remote mix manifold is used in your system.

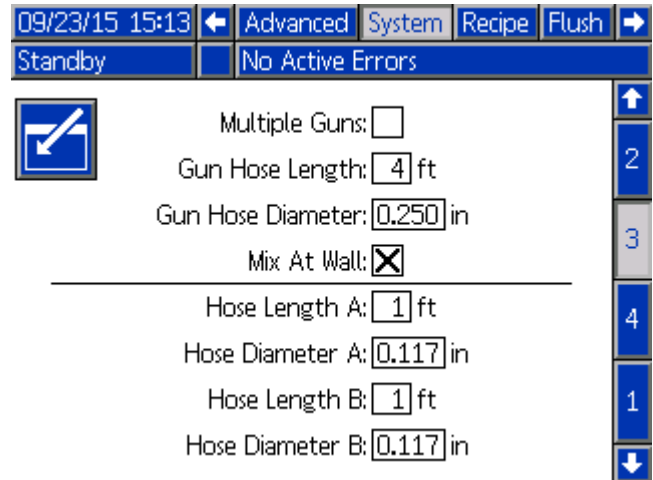

Figure 37 System Screen 3, Mix At Wall

Hose Length and Diameter

Enter the length and diameter of the hose from the remote color stack to the remote mix manifold, for both A and B hoses.

NOTE: These fields are enabled only if Mix at Wall is enabled.

Mix At Belt Circ.

Select this box if your system is using mix-at-belt mixing manifolds and has color change valves with circulation ports. (See Color Change Kits manual 3324555 for more information on circulation valves.) With this option selected, the PD2K system will deliberately interrupt the circulation path when an alarm occurs while in Mix mode by leaving the outlet stack color change valve open. This will prevent a user from dispensing material out the gun if an alarm has occurred. The system will return to normal operation once the user has changed the system state.

Information for Systems with Multiple Guns

For Systems Without Mix at Wall

The Multiple guns feature enables the ability to simultaneously track up to 60 different mixed material recipes, each loaded into a dedicated gun. This feature is enabled on [System Screen 3, page 43](#).

Recipe Screen

Because the system has a dedicated gun for each recipe, the associated hose length and diameters could be unique. Therefore, these parameters are disabled on [System Screen 3, page 43](#), and now appear on the [Recipe Screen, page 50](#). Enter the hose length and diameter for a gun that will spray a particular recipe.

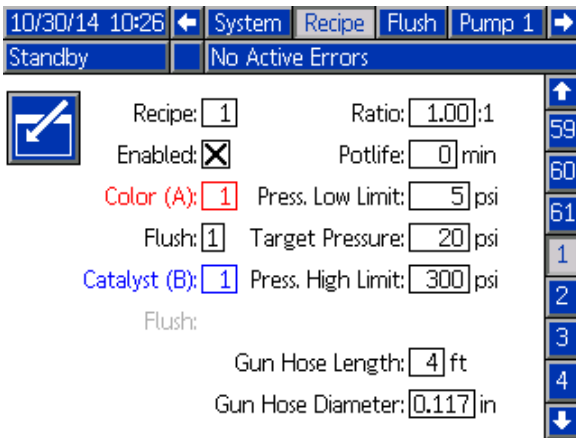

Figure 38 Recipe Screen, without Mix at Wall

Potlife Screen

In Run mode, the Potlife Screen appears in the menu bar between Fill and Usage. This screen displays how much time remains in the potlife of any given recipe (gun). Recipes are highlighted and show remaining potlife time only if that gun is filled with mixed material and has a non-zero potlife.

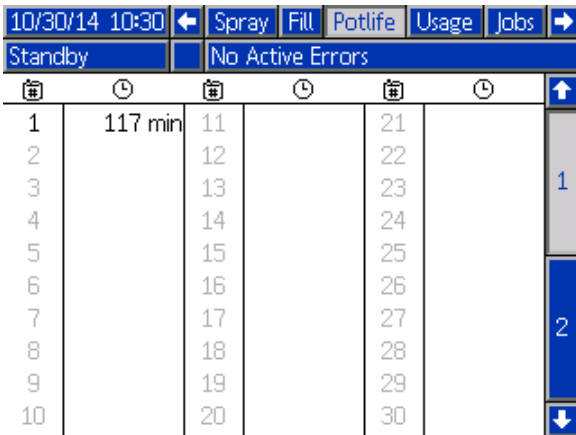

Figure 39 Potlife Screen, without Mix at Wall

Changing Recipes or Purging

When Multiple Guns is enabled, the Spray Screen allows the user either to change the active recipe (the recipe that is loaded in the pumps) or to purge a particular gun (recipe). Select either Recipe or Purge from the dropdown menu and enter the recipe number. Use the Purge soft key to purge the active recipe.

These actions also can be done using the Booth Control. Use the normal procedure to change the active recipe or to purge the active gun. See [Booth Control, page 22](#). To purge a gun that is not

active currently, scroll Up or Down

to the desired recipe. Then press Purge . If Purge is not pressed within 5 seconds, the system will revert to the active recipe number.

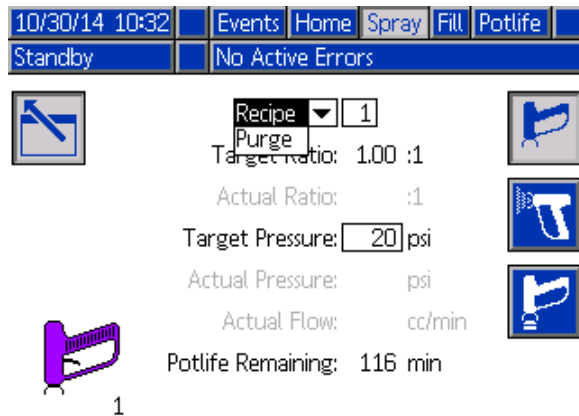

Figure 40 Spray Screen, without Mix at Wall

For Systems with Mix at Wall

A ProMix PD2K with remote mix manifold normally operates with a single gun, but may be configured to use multiple (up to 3 maximum) remote mix manifolds and guns. Having multiple guns has the advantage of very fast color change, the system could have a recipe loaded in each gun and could then switch between them almost instantly. The PD2K will also track potlife time for multiple mixed recipes.

The Multiple Guns operation mode may be enabled on System Screen 3 by checking the box and then subsequently entering the number of guns for the system in the field labeled **Number**.

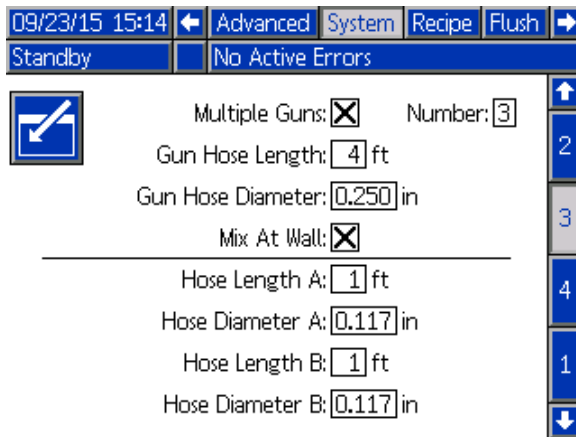

Figure 41 System Screen 3, with Multiple Guns and Mix At Wall

Each color in the system must be assigned to a single gun. Assignment of the color to gun is done on Pump #, Screen 4 by entering the gun number next to the color number.

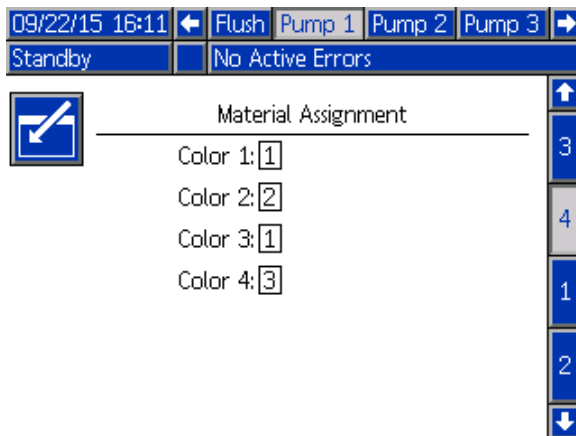

Figure 42 Pump Screen 1, Material Assignment

Catalysts may be assigned to a single gun, shared among multiple guns (common), or a mix of both. Only one catalyst per pump may be configured as Common, and because each assignment requires a remote valve, the total number (including each common assignment) cannot exceed four. To configure a catalyst as common to multiple guns, check the Common box and then select all appropriate guns.

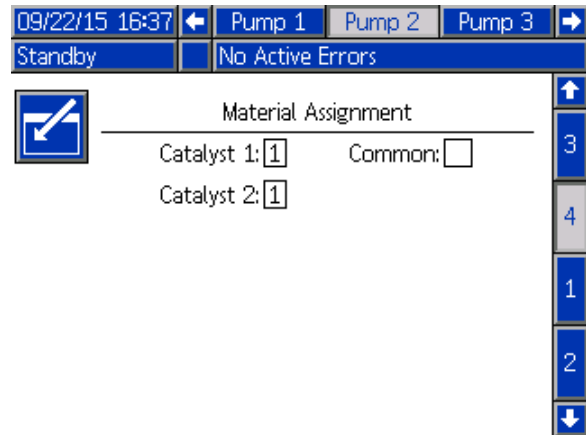

Figure 43 Pump Screen 2, Material Assignment without Common Catalyst

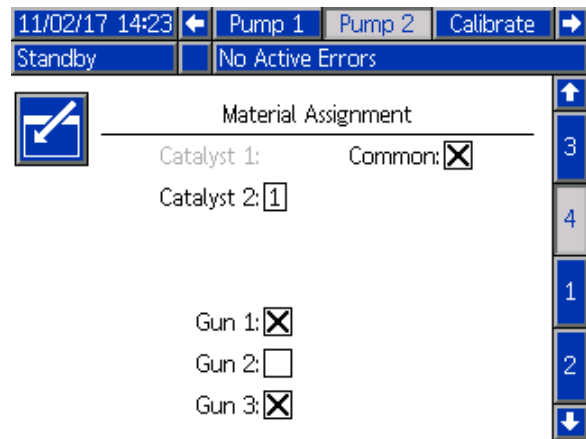

Figure 44 Pump Screen 2, Material Assignment with Common Catalyst

Recipes can only be set up to use a color and catalyst that are assigned to the same gun. If the color and catalyst gun assignments do not match, the recipe will be invalidated and disabled. See Recipe Screen for more info on invalid recipes.

When Common catalysts are used, the system will automatically allocate each gun assignment to a unique remote catalyst valve (1-4), shown in table 3. On the left, locate the row that has 1) the number of catalyst pumps, 2) the catalyst valve map selection (see Pump Screen 1), and 3) the appropriate common catalyst configuration for your system. Following along that row to the right will reveal the system's remote catalyst valve allocation.

Table 3 Remote Catalyst Valve allocation for system using Common Catalyst

Cat- alyst Pumps	Valve Map Selection	Pump 2: Common Catalyst	Pump 4: Common Catalyst	Remote Catalyst Valve 1	Remote Catalyst Valve 2	Remote Catalyst Valve 3	Remote Catalyst Valve 4
1	Standard	None	N/A	Catalyst 1	Catalyst 2	Catalyst 3	Catalyst 4
1	Standard	Common to Guns 1 & 2	N/A	Catalyst 1 (Gun 1)	Catalyst 1 (Gun 2)	Catalyst 2	Catalyst 3
1	Standard	Common to Guns 1 & 3	N/A	Catalyst 1 (Gun 1)	Catalyst 1 (Gun 3)	Catalyst 2	Catalyst 3
1	Standard	Common to Guns 2 & 3	N/A	Catalyst 1 (Gun 2)	Catalyst 1 (Gun 3)	Catalyst 2	Catalyst 3
1	Standard	Common to Guns 1–3	N/A	Catalyst 1 (Gun 1)	Catalyst 1 (Gun 2)	Catalyst 1 (Gun 3)	Catalyst 2
2	Standard	None	—	Catalyst 1	Catalyst 2	—	—
2	Standard	Common to Guns 1 & 2	—	Catalyst 1 (Gun 1)	Catalyst 1 (Gun 2)	—	—
2	Standard	Common to Guns 1 & 3	—	Catalyst 1 (Gun 1)	Catalyst 1 (Gun 3)	—	—
2	Standard	Common to Guns 2 & 3	—	Catalyst 1 (Gun 2)	Catalyst 1 (Gun 3)	—	—
2	Standard	—	None	—	—	Catalyst 3	Catalyst 4
2	Standard	—	Common to Guns 1 & 2	—	—	Catalyst 3 (Gun 1)	Catalyst 3 (Gun 2)
2	Standard	—	Common to Guns 1 & 3	—	—	Catalyst 3 (Gun 1)	Catalyst 3 (Gun 3)
2	Standard	—	Common to Guns 2 & 3	—	—	Catalyst 3 (Gun 2)	Catalyst 3(Gun 3)
2	Alternate	None	N/A	Catalyst 1	Catalyst 2	Catalyst 3	Catalyst 4
2	Alternate	Common to Guns 1 & 2	N/A	Catalyst 1 (Gun 1)	Catalyst 1 (Gun 2)	Catalyst 2	Catalyst 4
2	Alternate	Common to Guns 1 & 3	N/A	Catalyst 1 (Gun 1)	Catalyst 1 (Gun 3)	Catalyst 2	Catalyst 4
2	Alternate	Common to Guns 2 & 3	N/A	Catalyst 1 (Gun 2)	Catalyst 1 (Gun 3)	Catalyst 2	Catalyst 4
2	Alternate	Common to Guns 1–3	N/A	Catalyst 1 (Gun 1)	Catalyst 1 (Gun 2)	Catalyst 1 (Gun 3)	Catalyst 4

With Multiple Guns enabled, the system requires two additional remote solvent valves for each gun. Because of this, the total number of colors is reduced to 26 and the valve map for the IS color change

modules are configured differently. Refer to Color Change and Remote Mix Kit manual 333282 for more detail.

Spray Screen

The Spray Screen provides the same information and operating capabilities as with a single gun (see [Spray Screen, page 35](#)), but has the added capability of purging one of the guns that is not currently active (The active gun is, or was most recently, spraying or loading mixed material). If the system is in Standby, the user may select 'Purge' and enter the recipe number to be flushed from an inactive gun. When the gun purge has been completed, the system returns to control of the active gun. This provides the ability to purge a gun that is currently inactive but loaded with mixed material that has an expired potlife.

The Spray Screen will also indicate which recipe is loaded in each gun, with the active gun highlighted.

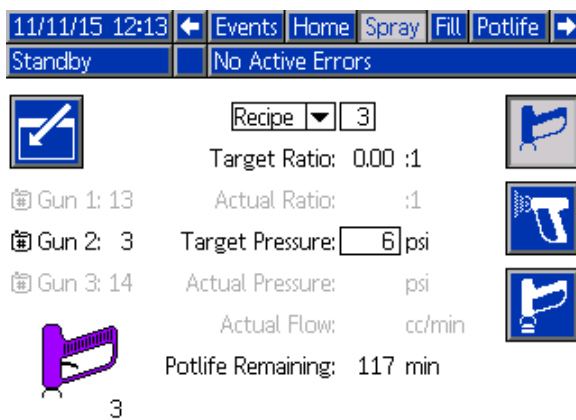

Figure 45 Spray Screen, with Mix at Wall

NOTE: Only a recipe that is loaded in one of the guns may be selected to be purged. This prevents inadvertent purging of a desired loaded recipe.

Fill Screen

The Fill Screen operates the same as with a single gun (see [Fill Screen, page 36](#)).

NOTE: When filling a line, it is important to know and trigger the appropriate gun to which the material is assigned to avoid over-pressurizing the system.

When filling a line with a catalyst that is common, the user will also need to select one of the guns. The system will open the appropriate valves and fill material to the selected gun.

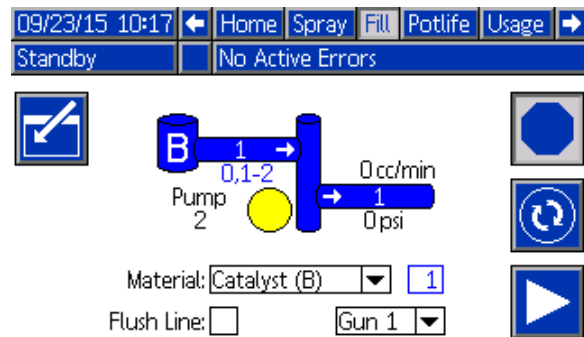

Figure 46 Fill Screen, with Mix at Wall

Setup Mode Screens

Potlife Screen

With Multiple Guns enabled an additional Run Mode is now accessible. This screen will show all recipes that are currently loaded in a gun with potlife remaining. The remaining potlife time is displayed.

09/23/15 10:24					
Standby					
No Active Errors					
	⌚	📅	⌚	📅	⌚
1	51 min	11		21	
2	119 min	12		22	
3		13		23	
4		14		24	
5		15		25	
6		16		26	
7		17		27	
8		18		28	
9		19		29	
10		20		30	

Figure 47 Potlife Screen, with Mix at Wall

Maintenance Screen 4

Color change valves may be manually overridden from Maintenance Screen 4 the same as with a single gun (see [Maintenance Screen 5, page 67](#)).

For a catalyst configured as common, the user will have to identify which remote valve to cycle by selecting the appropriate gun.

09/23/15 10:28					
Standby					
No Active Errors					
Valve Resets and Test					
Material: Catalyst (B) 1					
12345 00000	Inlet	19 cycles	Open	<input type="checkbox"/>	
12345 00000	Outlet	12 cycles		<input type="checkbox"/>	
12345 00000	Gun 1	97 cycles		<input type="checkbox"/>	

Because each gun has its own unique remote solvent valves, when overriding a remote solvent valve the user will similarly have to identify the appropriate gun.

NOTE: For remote solvent valves, the pump number only identifies whether the valve is for the color solvent valve (color pump number) or for the catalyst solvent valve (catalyst pump number).

09/23/15 10:35					
Standby					
No Active Errors					
Valve Resets and Test					
Pump: Solvent 1					
12345 00000	Inlet	51 cycles	Open	<input type="checkbox"/>	
12345 00000	Dump	77 cycles		<input type="checkbox"/>	
12345 00000	Gun 1	2 cycles		<input type="checkbox"/>	

Gateway Screen

Gateway Screen sets the following system operating parameters. This screen is needed only for systems that use AWI.

04/17/14 14:46 ← Advanced System Recipe Flush →

Standby No Active Errors

Gateway: Modbus TCP - 1

Enable:

DHCP:

IP: 10 33 131 238

Subnet: 255 255 0 0

Gateway: 10 33 1 1

DNS1: 10 33 1 45

DNS2: 10 33 1 47

Figure 48 Gateway Screen

Gateway ID

Select the desired Gateway ID from the dropdown menu.

Enable

Uncheck Enable while setting the IP Address, Subnet mask, Gateway, DNS1 or DNS2. When the settings are loaded, check the Enable box to write the new settings to the selected Gateway.

Check this box to enable the selected Gateway so that the PLC can communicate with it.

DHCP

Select this box if your system has a Dynamic Host Configuration Protocol (DHCP). This protocol assigns unique IP addresses to devices, then releases and renews these addresses as devices leave and rejoin the network. If selected, the IP Address, Subnet, and Gateway fields will not be editable and will display the addresses supplied by the DHCP.

TCP/IP

Use the remaining fields to set the IP address, subnet mask, Gateway, DNS1, and DNS2.

Recipe Screen

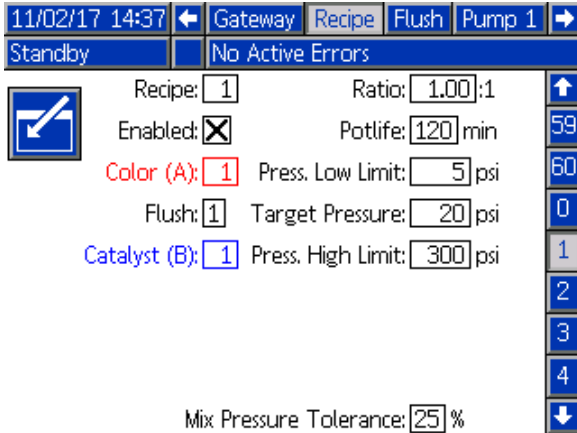

Figure 49 Valid Recipe Screen

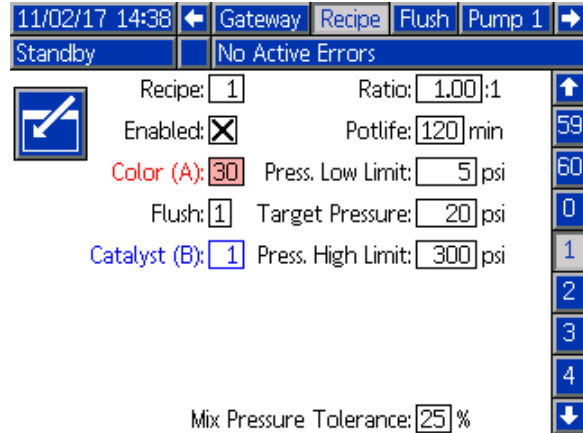

Figure 50 Invalid Recipe Screen

Recipe

Enter the desired recipe number (1-60).

Recipe 0

Use Recipe 0 to flush the system.

- **If a recipe (1–60) is loaded:** Select Recipe 0 to flush the previously active pumps and purge the gun.
- **If Recipe 0 or 61 is loaded:** Select Recipe 0 to flush all pumps and purge the gun.

Enabled

Selecting “Enabled” makes the selected recipe accessible from the booth control, in addition to the ADM. The booth operator can then quickly select a desired recipe, without scrolling through all 60.

Color (A) Valve

Enter the desired color valve number (1-30).

NOTE: If you enter a number which is not valid in your system configuration, the field will be highlighted and the recipe becomes invalid. For example, if your configuration has 8 color valves and you enter 30, the field will appear as shown in the Invalid Recipe Screen example.

Catalyst (B) Valve (disabled in 1K Mode)

Enter the desired catalyst valve number (1-4).

NOTE: If you enter a number which is not valid in your system configuration, the field will be highlighted and the recipe is invalid. For example, if your configuration has 1 catalyst valve and you enter 4, the field will be highlighted and the recipe is invalid.

Flush Sequence

Enter the desired flush sequence (1-5). For hard to flush colors, select a longer sequence. 1 is the default, and should be designated for the longest, most thorough flush duration.

If Mix at Wall is enabled on System Screen 3, enter the desired flush sequence (1–5) for the color (A) valve and the catalyst (B) valve. The gun purge time for each material depends on the flush sequence assigned to each. See [Flush Screen, page 53](#). If materials A and B require different purge times, assign separate flush sequences. Set the necessary gun purge time for each. For hard to flush colors, select a longer sequence. Flush sequence 1 is the default, and should be designated for the longest, most thorough flush duration.

Mix Ratio (disabled in 1K Mode)

Enter the desired mix ratio (0 to 50.0):1.

Potlife Time

Enter the potlife time (0 to 999 minutes). Entering 0 disables this function.

Pressure Low Limit

Enter the lowest target pressure which the operator is allowed to enter from the Spray screen or booth control. The default is 5 psi (.035 MPa, 0.35 bar).

Target Pressure

Enter the desired target spray pressure. This is the pressure the pumps will maintain at the outlet. The default is 20 psi (0.14 MPa, 1.4 bar).

Pressure High Limit

Enter the highest target pressure which the operator is allowed to enter from the Spray screen or booth control. The default is 300 psi (2.1 MPa, 21.0 bar).

NOTE: If you enter an invalid pressure for your system's parameters, the field will be highlighted and the recipe is invalid. For example, if you enter 1500 psi (10.5 MPa, 105 bar) in a low pressure system, the field will be highlighted and the recipe becomes invalid.

11/02/17 14:47 Gateway Recipe Flush Pump 1
 Standby No Active Errors
 Recipe: 1 Ratio: 1.00:1
 Enabled: Potlife: 120 min
 Color (A): 1 Press. Low Limit: 5 psi
 Flush: 1 Target Pressure: 20 psi
 Catalyst (B): 1 Press. High Limit: 300 psi
 Flush: 2 Purge 1: A
 Dual Solvent: Purge 2: B
 Fill: A Then B Purge 3: A
 Mix Pressure Tolerance: 25 %

Dual Solvent

If Mix at Wall is enabled on System Screen 3, Dual Solvent becomes an option on the Recipe Screen. Dual Solvent enables the sequencing of flushing of the mixed material for a system using two types of solvent (for example, water- and solvent-based) that should not be mixed together.

Fill

Select the sequence for dispensing material into the mix hose and gun. The choices are A then B, B then A, and Parallel if no fill sequencing is necessary. The fill sequence is typically dictated by the last material used in the purge sequence.

Purge 1, 2, and 3

Select the sequence for purging the mixed material from the mix hose and gun. Each stage of the sequence can be set to either A or B. The solvent corresponding to each material will be dispensed out of the gun for the Gun Purge Time of the Flush sequence assigned to that material for each stage.

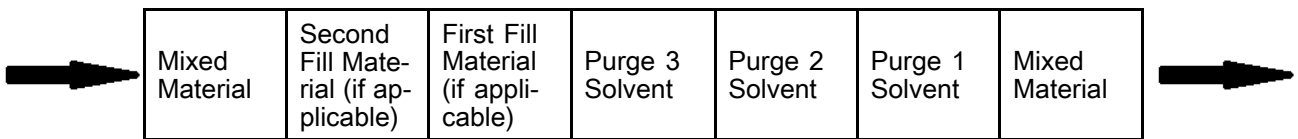

Direction of flow during dual solvent purge and then fill.

Mix Pressure Tolerance

The pressure of one component must be within a percentage (\pm) of the pressure of the other

component during spray or mix. Set the desired Mix Pressure Tolerance in this field. The default is 25%. See [Differential Pressure and the Mix Pressure Tolerance Set Point](#), page 52.

Differential Pressure and the Mix Pressure Tolerance Set Point

A primary means of maintaining ratio assurance for the ProMix PD2K system is through monitoring of the differential pressure between the A-pump outlet and the B-pump outlet. Ideally these two pressures would be identical, but factors such as line sizing, viscosity, and mix ratio will lead to some variation. Understanding where your system typically operates is imperative to setting up an effective differential pressure check that will notify the user when something has caused the accuracy of the mix ratio to come into question, but also not generate nuisance alarms.

It is recommended that once the system is fully installed and ready for use, that the user load a recipe and spray mixed material. While spraying, take note of the outlet pressures of both the A and B pumps (This can be seen on the main screen of the ADM), spray long enough that the pressures have stabilized to a nominal value. The difference between the outlet pressures of the A and B pump are an established baseline for the Mix Pressure Tolerance Set Point.

The Mix Pressure Tolerance set point allows the B-side pump outlet pressure to vary a specified percent away from the A-side pump outlet (spray) pressure. As an example, if the spray pressure (A-side pump outlet pressure) is 100 psi, and the Mix Pressure Tolerance is set to 25%, then the B-side outlet pressure is allowed to float between 75 psi (100 psi - 25%) and 125 psi (100 psi + 25%) before generating an alarm.

If, during operation the system has generated a lot of differential pressure alarms, or if it will mix a wide variety of materials and at different mix ratios, the Mix Pressure Tolerance may have to be increased. Otherwise it is recommended to maintain this set point as tight as is possible to alert the user that something might be affecting the mix ratio accuracy.



* Acceptable Range
 A: A pump nominal output pressure
 B: B pump nominal output pressure

The acceptable B-side pump outlet pressure range for a system with a target spray pressure of 100 psi and a Mix Pressure Tolerance of 25%.

Flush Screen

Figure 51 Flush Screen

Flush Number

Enter the desired flush sequence (1-5). For hard to flush colors, select a longer sequence. 1 is the default, and should be designated for the longest, most thorough flush duration.

Air/Solvent Chop

If Mix At Wall is enabled on System Screen 3, this option is available. Enable an air and solvent chop for flushing the gun rather than just a solvent purge. See [Air/Solvent Chop, page 54](#).

Air and solvent chop may also be enabled for flushing out a pump. See [Custom Valve Mapping, page 57](#) for more information.

NOTE: Air/solvent chop requires additional hardware for the air purge valve. See manual 333282 for kit numbers and installation.

Initial Flush

Enter the initial flush volume (0 to 9999 cc).

Wash Cycles

A Wash Cycle activates the pump with the valves closed, to use pumping motion to thoroughly clean the pump. Enter the desired number of wash cycles (0 to 99). Entering a number will make the Strokes per Cycle field active.

Strokes per Wash Cycle

Enter the desired pump strokes per wash cycle (0 to 99). Default is 1.

Final Flush

Enter the final flush volume (0 to 9999 cc).

Gun Purge Time

Enter the gun purge time (0 to 999 seconds).

Air/Solvent Chop

Air/Solvent Chop replaces the standard Gun Purge Time parameter on the Flush screen. Instead the purge is split into three phases: First Purge, Chop, and Final Purge. The Chop Phase will always start with Air and each phase has multiple configuration parameters.

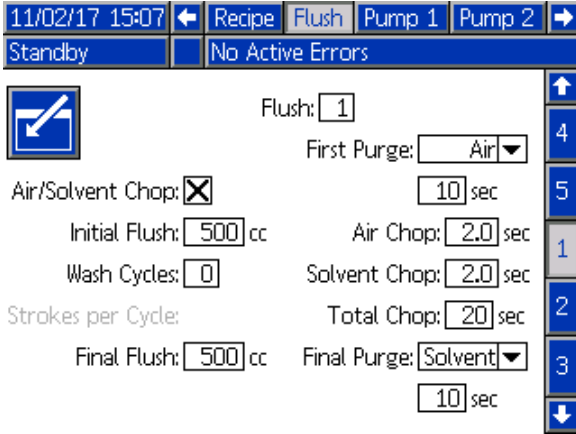

Figure 52 Flush Screen with Air/Solvent Chop

First Purge

Select the material to be either Air or Solvent and the length of time for the first purge phase, which dispenses only the material selected.

Air Chop

Set the air chop duty cycle for the chop phase.

Solvent Chop

Set the solvent chop duty cycle for the chop phase.

Total Chop

Set the length of time for the chop phase. The system will switch between air and solvent pulses according to the duty cycles set for the length of the Total Chop time.

Final Purge

Select the material to be either Air or Solvent and the length of time for the final purge phase, which dispenses only the material selected.

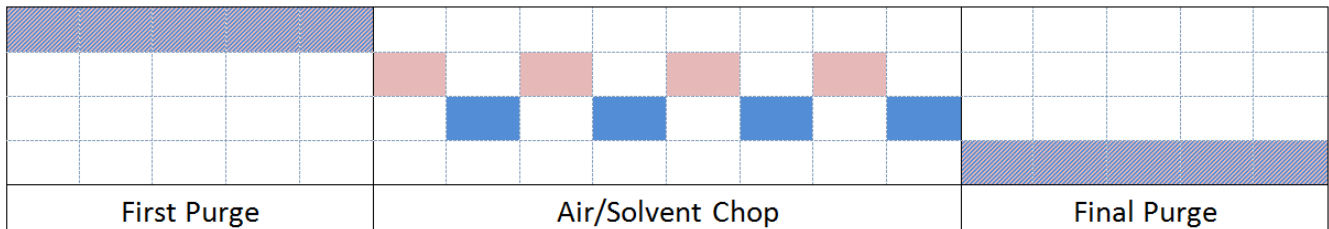

Air
 Solvent
 Either

Figure 53 Air/Solvent Chop Timing Diagram

Pump Screen 1

NOTE: Your system may include 2, 3, or 4 pumps. Information for each pump is accessible under a separate tab in the menu bar at the top of the screen. Select the tab for the desired pump. Each pump has three screens. Only the screens for Pump 1 are shown here, but the same fields appear on all.

Pump screen 1 includes the following fields which define the pump.

Figure 54 Pump Screen 1 — Resin Pump

Figure 55 Pump Screen 1 — Catalyst Pump

Pump Size

Select 35cc or 70cc, as appropriate.

Inlet Pressure

Select one of the following:

- Disabled
- Monitor, to track inlet pressure

Select Color Change

Select this box if your system uses color change.

Materials

Enter the number of materials used in your system. Each color change module controls 8 colors.

Total Hose Length

Compute the length of the hoses from the supply stack to the pump and from the pump to the outlet stack. Enter the total length.

Pump Hose Diameter

Enter the diameter of the supply and output hoses.

Available Colors

The module displays the number of colors available in your system. This field is not editable.

Color Change Valve Mapping

Valve Mapping

Select whether to use Standard, static valve mapping, or fully configurable Custom valve mapping. The color change valve mapping is the assignment of the location of the solenoids in the color change control modules. A static, pre-determined map layout makes for an easily predictable and hands-free option. However, an application and user may benefit from laying out the valve mapping on their own for consolidation of equipment, reduced hardware complexity, or simply to lay out valves according to what makes most sense.

See Custom Valve mapping for more detailed information.

Remote Valve Map

Select an alternate static valve map for the IS color change modules. This is useful for a system that has more than one color pump but relatively few color change materials. The alternate maps allow for

consolidating 2 color pumps (Alternate 1) or 3 color pumps (Alternate 2) onto a single IS color change module. See the Color Change and Remote Mix Manifold Kits manual 333282 for valve maps.

NOTE: This selection is only available on Pump Screen 1 for color pumps when Mix at Wall is also enabled.

Catalyst Valve Map

Select an alternate static valve map for a system with 2 catalyst pumps that requires one pump to change among 3 catalysts (Module 5) and only a single catalyst on Pump 4 (Module 6 if color change is still used for this pump). See the Color Change and Remote Mix Manifold manual 333282 for more information.

NOTE: This selection is only available on Pump Screen 1 for catalyst pumps with color change enabled.

Custom Valve Mapping

For a PD2K system that has color change, the user has an option for how the control solenoids are mapped on the control modules. Selecting Standard (default) will use the traditional, static valve mapping. The static maps are laid out logically and established for retro-fitting. If Standard is selected no additional set up for the color change valves is required at the ADM. For more information or to see the static map layouts, refer to manuals 332455 and 333282.

By selecting Custom, every color change solenoid may be assigned to any unique, valid control module location. This option offers the ultimate customization as well as the benefit of consolidation of equipment. Additionally, custom valve mapping enables some advanced color change valve features.

NOTE: This option applies to all pumps, so changing it for one will change it for all.

NOTE: When going from Standard to Custom, the PD2K will automatically pull in the static map assignments for all valves as a starting point. When going from Custom to Standard, the PD2K will clear all custom valve assignments and revert to the static mappings.

Pump Screen - Advanced Configuration

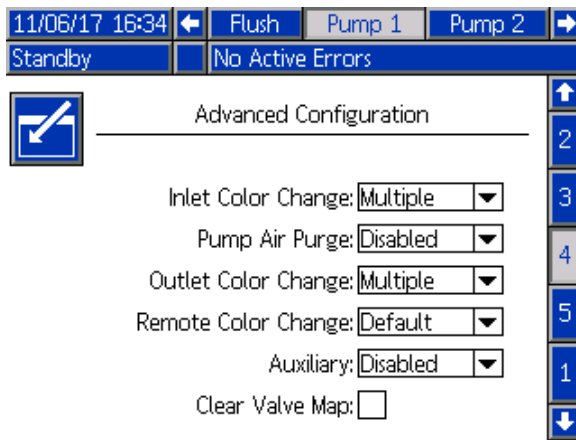

Figure 56 Pump Screen, Advanced Configuration

Inlet Color Change

Select Multiple if each individual material has its own valve on the inlet color stack for a particular pump. Select Single if there is more than one material using

a single valve on the inlet color stack (i.e., a piggable system). This option is only available for pumps that have more than one color change material.

NOTE: For systems that select Single, it is expected the user knows when a particular material is plumbed and filled to the inlet stack before performing a color change. The PD2K system does not know what material is connected up stream of the inlet valve stack.

Pump Air Purge

Select Enable to add an air purge valve to the pump inlet stack to allow for an air/solvent chop flush of the pump out the dump valve. Select Disable if no air purge valve will be used for the pump. This option is only available for color pumps. See Pump Air/Solvent Chop on [Pump Screen - Valve Assignment, page 59](#) for further detail.

Outlet Color Change

Select Multiple if each individual material has its own valve on the outlet color stack for a particular pump. Select Single if there is more than one material using a single hose connected to the outlet color stack. This option is only available for pumps that have more than one color change material.

NOTE: If Single is selected, the hose connected to the outlet stack will need to be purged before completing a color change.

Remote Color Change

Select Multiple if each individual material has its own valve on the remote color stack for a particular pump. Select Single if there is more than one material using a single hose connected to the remote color stack. Select Disable if there are no remote color change valves (only solvent and air purge) for the pump. The Disable option is only available if Mix-at-Wall is enabled, and Single is only available for pumps that have more than one color change material.

NOTE: Unless Disabled is selected, this must match the selection for Outlet Color Change unless.

NOTE: If Single is selected, the hose connected between the outlet stack and remote stack will need to be purged before completing a color change.

Auxiliary

Select Enable to add an auxiliary valve downstream of the remote valve stack of the pump. The Auxiliary valve is only opened when that particular pump is dispensing (either mixing or purging). This option is only available if Mix-at-Wall is enabled, and also Multiple Guns is not enabled.

The following figure illustrates an example application of the auxiliary valve. Pumps 1 and 3 both dispense color, but one is solvent based and one is water based. (Pump 2 dispenses a catalyst.) With the auxiliary valves in place for both pumps, only one will flow through the A-side of the remote mix manifold, and the other is completely isolated by the auxiliary valve.

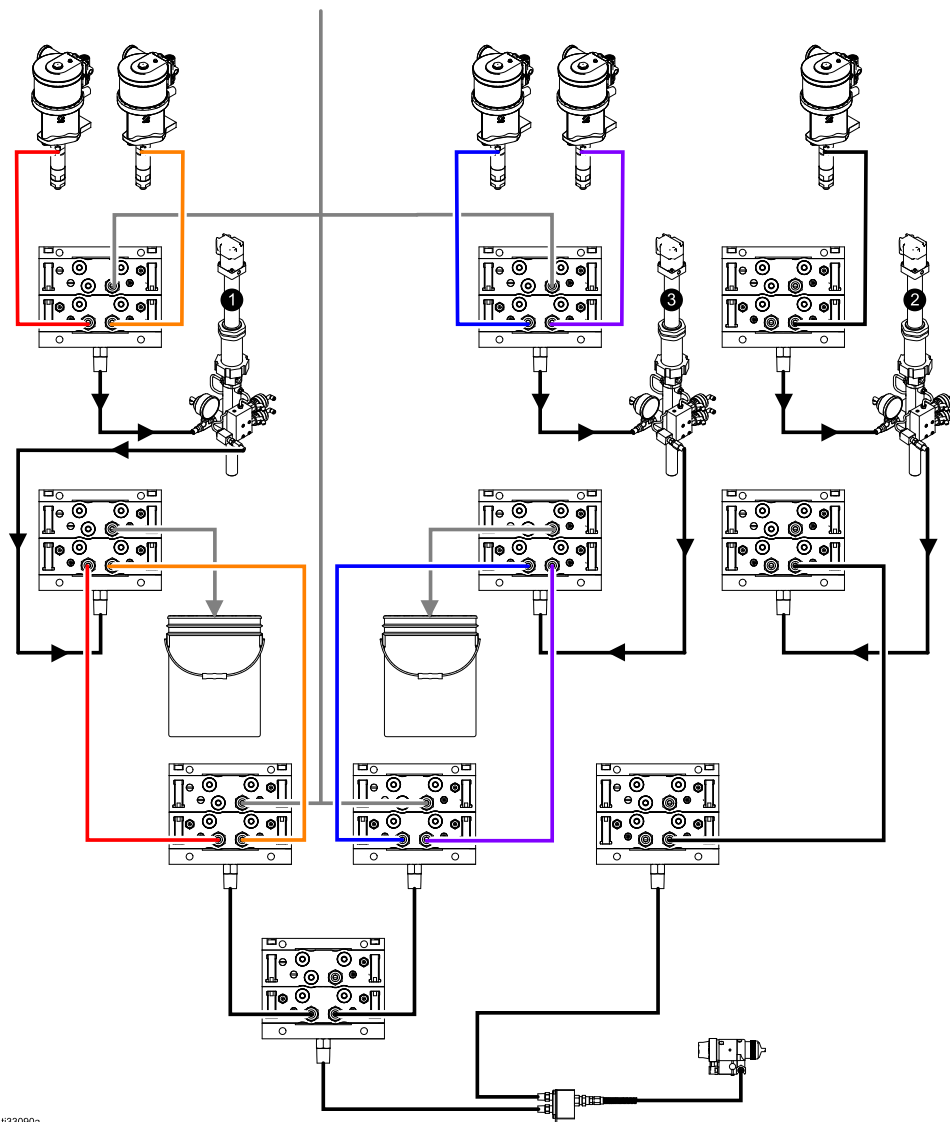

t33090a

Figure 57 Example Application of the Auxiliary Valve

Clear Valve Map

Check this box to clear all valve assignments. The user will be prompted to confirm the choice. This will erase any valve assignments permanently, including

any that were automatically set based on the static mapping.

Pump Screen - Valve Assignment

11/06/17 17:49		←	Flush	Pump 1	Pump 2	→
Standby		No Active Errors				
	Valve		Location		↑ 3 4 5 1 2 ↓	
	Inlet	Solvent	1	01		
	Inlet	Color 1	1	02		
	Inlet	Color 2	0	00		
	Outlet	Dump	1	10		
	Outlet	Color 1	1	11		
	Outlet	Color 2	0	00		
	Remote	Solvent	Gun 1	00		
	Remote	Color 1		00		
Remote	Color 2		00			

Figure 58 Pump Screen, Valve Assignment

location. The list of valves will automatically populate based on the settings that apply to the pump. A description of the valve includes what stack it belongs to, the material identification, and a specific gun or pump designator, if that applies.

NOTE: Some remote stack valves may be shared by more than one pump. They will show up on the valve list for all pumps to which they apply.

All color change valves require a valid location be assigned for the system to be able to operate properly. There are two columns that determine the solenoid location. The left column is the color change module number. This number must be between 1 and 8 and should reflect the dip switch settings on one of the color change boards (see manual 332455 for more details on dip switch settings). The second column is the solenoid location, and this number must be between 1 and 18. The following figure shows the solenoid location enumeration.

This screen allows the user to assign each individual color change valve solenoid in the system to a unique

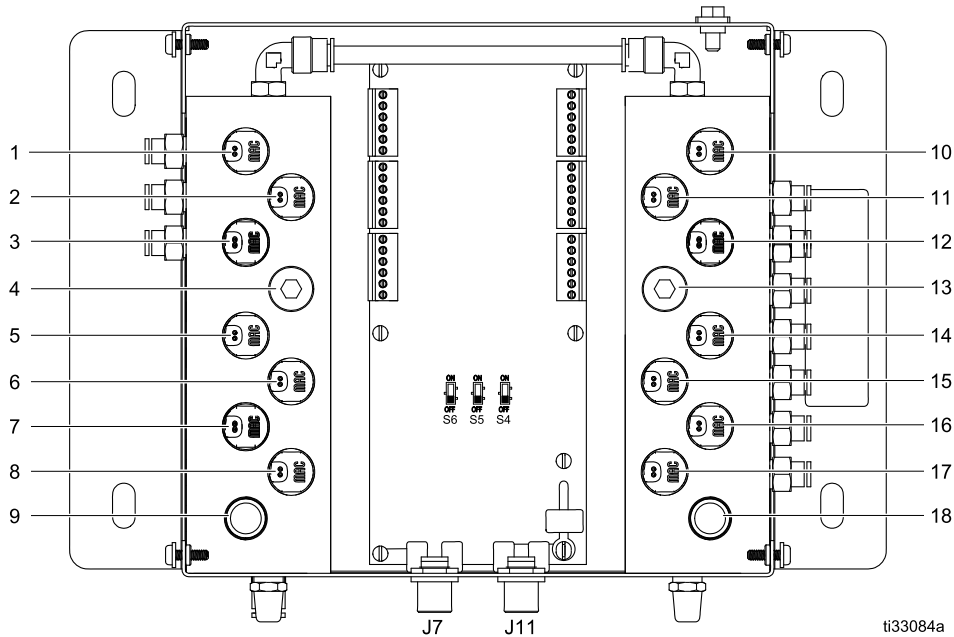

Figure 59 Solenoid Location Enumeration

Setup Mode Screens

If more than one valve is assigned a valid solenoid location, all instances of that location will be highlighted in red, and are considered invalid.

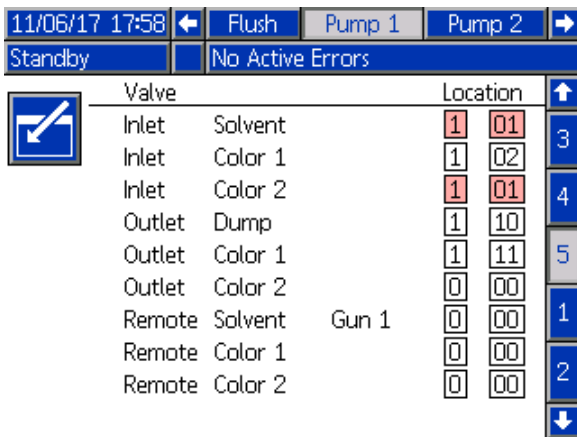

Figure 60 Pump Screen, Valve Assignment with duplicates

A value of 0 for the control module, or 00 for the solenoid, indicates no previous location assignment and both are also invalid assignments.

If a valve location is considered invalid, any operation that uses that valve will be prevented from running. This is easily identified on the Recipe screens. If any of the material's valves are considered invalid, that material will be highlighted red. If any of the valves used in the flush procedure are considered invalid, the flush sequence will be highlighted red.

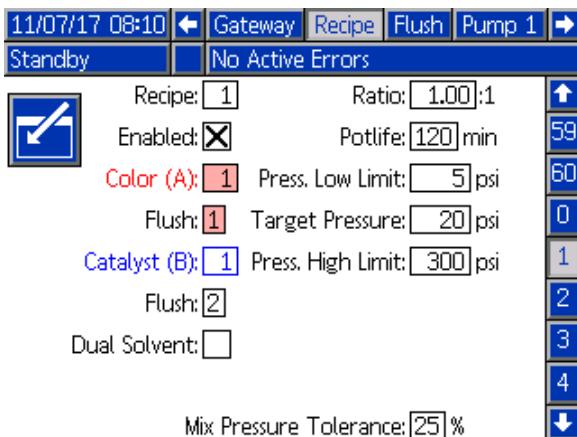

Figure 61 Recipe Screen with invalid valve location

Pump Air/Solvent Chop

Enabling an air purge valve on the inlet stack of a color pump allows for an air/solvent chop during the pump flush process. The air/solvent chop will replace the wash cycles in a pump flush. Instead, the pump will run at a steady speed for the set number of strokes (full length travel in one direction) while alternating between air and solvent for the desired duty cycles. One pump stroke takes approximately 2 seconds during this phase.

NOTE: Air/solvent chop requires additional hardware for the air purge valve. See manual 333282 for kit numbers and installation details.

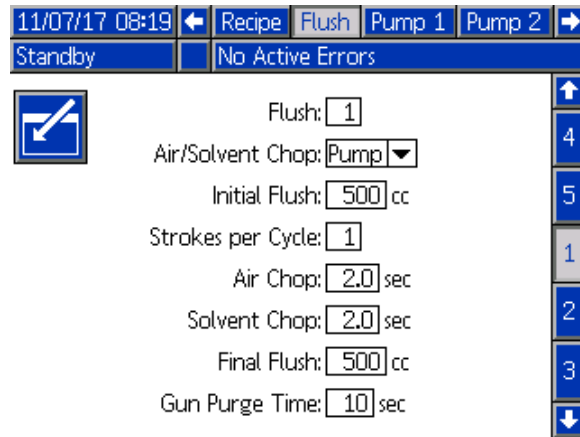

Figure 62 Flush Screen with pump air/solvent chop

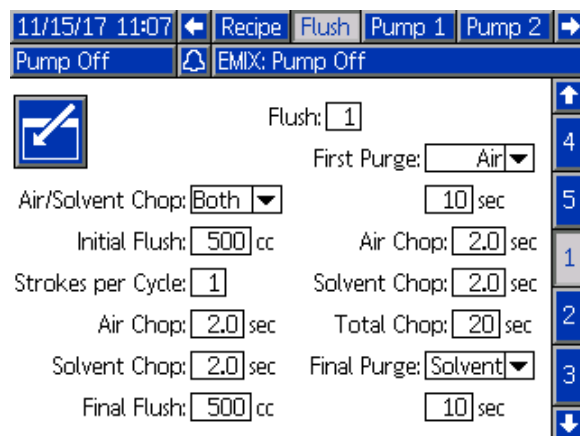

Figure 63 Flush Screen with both air/solvent chops

To enable air/solvent chop for a pump flush, check the Air/Solvent Chop box on the Flush screen. Because air/solvent chop may also be used for purging the gun, if Mix-at-Wall is enabled, the Air/Solvent Chop option becomes a pull-down selection where the user may choose None, Pump, Gun, or Both. If air/solvent chop is enabled for the gun purge, all gun purge parameters will appear on the right side, and pump flush parameters are on the left side. The following parameters apply to the pump flush. For details on air/solvent chop for the gun, see [Flush Screen, page 53](#).

Air Chop

Set the air chop duty cycle for the chop phase of the pump flush.

Solvent Chop

Set the solvent chop duty cycle for the chop phase of the pump flush.

Pump Screen 2

Pump screen 2 sets the pressure transducer settings for the pump.

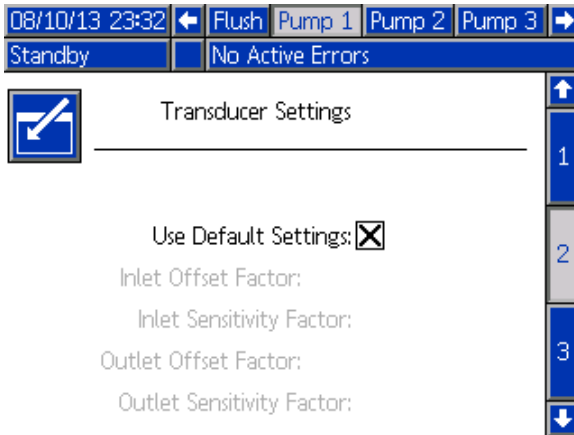

Figure 64 Pump Screen 2, Default Settings Enabled

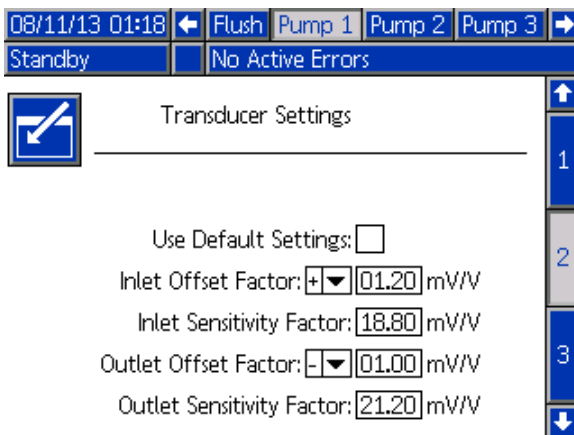

Figure 65 Pump Screen 2, Default Settings Disabled

Default Settings Selected

When the “Use Default Settings” box is selected, default settings are used for the calibration values, and the fields are grayed out.

Default Settings Not Selected

When the “Use Default Settings” box is not selected, the following calibration values must be entered. Invalid values will be over-ridden and the system will automatically select the default settings.

- Inlet Offset Factor: This field is only used if **Inlet Pressure** in [Pump Screen 1, page 55](#) is set to Monitor; it is grayed out if set to Disabled. The valid range is -01.20 to +01.20 mV/V.
- Inlet Sensitivity Factor: This field is only used if **Inlet Pressure** in [Pump Screen 1, page 55](#) is set to Monitor; it is grayed out if set to Disabled. The valid range is 18.80 to 21.20 mV/V.
- Outlet Offset Factor: The valid range is -01.20 to +01.20 mV/V.
- Outlet Sensitivity Factor: The valid range is 18.80 to 21.20 mV/V.

Pump Screen 3

Pump screen 3 sets the pressure alarm limits for the pump.

When **Inlet Pressure** in [Pump Screen 1, page 55](#) is set to Disabled, the inlet limit fields are grayed out and only the outlet limit fields are active. See [Pressure Alarm and Deviation Limits, page 62](#).

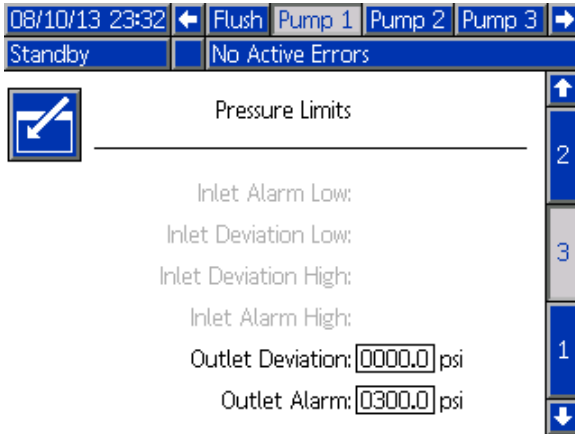

Figure 66 Pump Screen 3, Pressure Monitoring Disabled

When **Inlet Pressure** in [Pump Screen 1, page 55](#) is set to Monitor, all fields are active. See [Pressure Alarm and Deviation Limits, page 62](#).

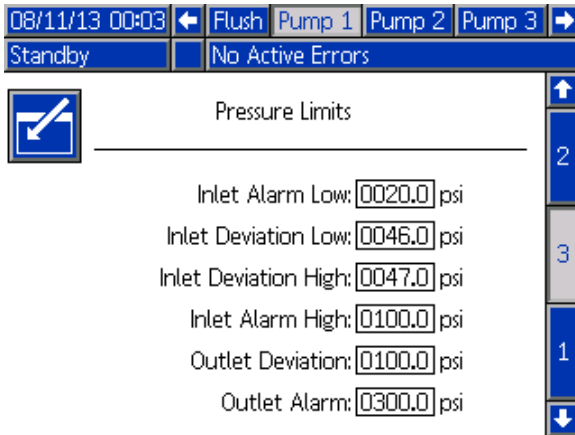

Figure 67 Pump Screen 3, Pressure Monitoring Enabled

Pressure Alarm and Deviation Limits

Inlet fields are only active if **Inlet Pressure** in [Pump Screen 1, page 55](#) is set to Monitor; they are grayed out if set to Disabled. Outlet fields are active at all times.

- Alarm and Deviation ranges are 0-300 psi for low pressure systems, and 0-1500 psi for high pressure systems.
- Setting to 0 will disable the alarm. The Inlet Alarm High and Outlet Alarm High **cannot** be disabled.
- Alarms and Deviations will display when the inlet or outlet pressure drops below the low limit or exceeds the high limit.

Pump Screen - Material Assignment

For systems using Multiple Guns and Mix-at-Wall, see [For Systems with Mix at Wall, page 45](#), for a description of use.

Calibrate Screen 1

Calibrate Screen 1 initiates a pump pressure check (stall test) for the selected pump. During the test, the Stall Test screen will appear.

The pump and lines must be primed with color or catalyst before doing the stall test. See [System Screen 2, page 41](#) to set test parameters. See [Pump Pressure Check, page 72](#) for complete test instructions.

To initiate the test, press the Pressure Check  button for the desired pump. The system will first check the material supply pressure at the PD2K pump. (**NOTE:** If this pressure is greater than 90% of the Stall Test Pressure the system will generate an alarm and halt the stall test.) Next, the pump will build pressure in the line to a minimum of the Stall Test Pressure. The pump will then move to the center stroke position and stall test the upstroke, followed by the downstroke.

NOTE: The Last Passed log can only be reset by successfully completing the test.

The screen displays the number of days since the last stall test was passed for each pump.

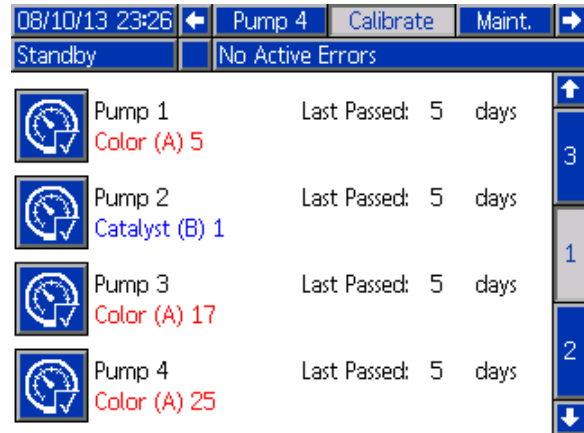

Figure 68 Calibrate Screen 1

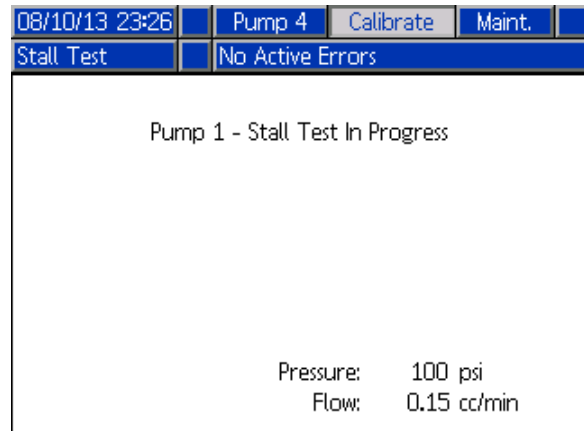



Figure 69 Stall Test Screen

Calibrate Screen 2

Calibrate Screen 2 initiates a volume test for the selected pump. During the test, the Volume Check screen will appear.

The pump and lines must be primed with color or catalyst before doing the Volume Check. See [Pump Volume Check, page 73](#) for complete test instructions.

To initiate the test, press the Volume Check  button for the desired pump.

The screen displays the volume dispensed. Press  to end the test.

Press and hold the Reset button  for 1-2 seconds to reset the volume counter.



Figure 70 Calibrate Screen 2

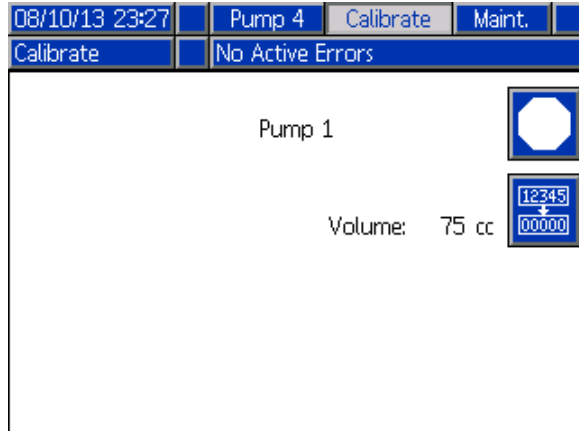



Figure 71 Volume Check Screen

Calibrate Screen 3



Calibrate Screen 3 initiates a calibration of an accessory solvent meter. During the test, the Volume Verification screen will appear.

The meter and lines must be primed with solvent before doing the calibration. See [Solvent Meter Calibration, page 74](#) for complete instructions.

To initiate the calibration, press the Volume Check  button.

The screen displays the volume dispensed. Enter the amount of solvent dispensed in the Measured

Volume field, or press  to end the test.

After the Measured Volume is entered, the Accept Calibration window will appear. Press  to accept the calibration. Press  to cancel the calibration and retain the previous K-factor.

Press and hold the Reset button  for 1-2 seconds to reset the volume counter.

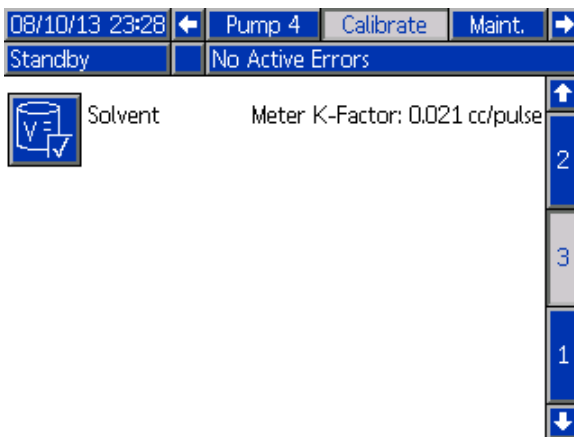

Figure 72 Calibrate Screen 3

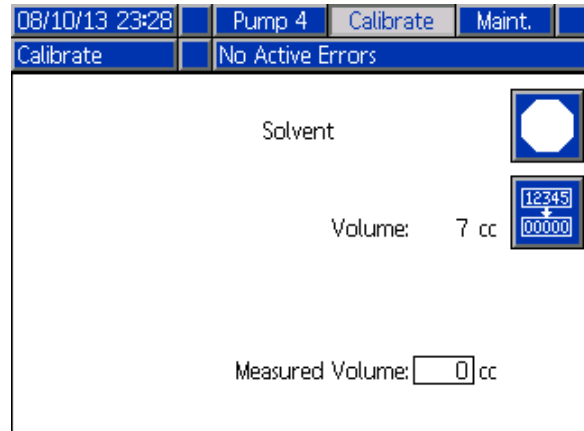

Figure 73 Enter Measured Volume of Solvent

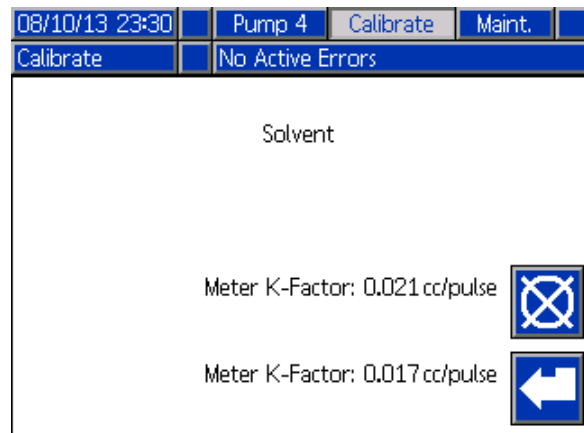

Figure 74 Accept Calibration

Maintenance Screen 1

Use this screen to set maintenance intervals. Set to 0 to disable the alarm.

NOTE: The Pump Stall Test cannot be disabled. You must enter a value other than 0.

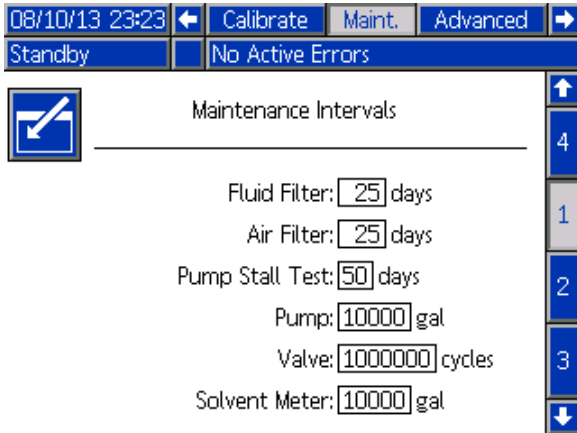



Figure 75 Maintenance Screen 1, Interval Settings

Maintenance Screen 2

Maintenance screen 2 shows the current interval status of the solvent meter, fluid filter, and air filter.

Press and hold the Reset button  for 1-2 seconds to clear the alarm and reset the counter.

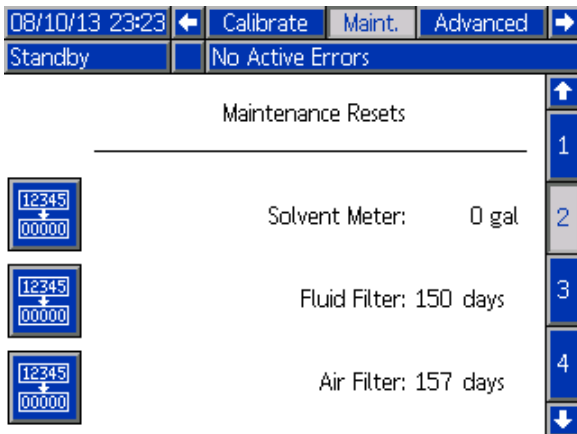



Figure 76 Maintenance Screen 2, Current Status

Maintenance Screen 3

Maintenance screen 3 shows the current interval status of the pump maintenance tests.

Press and hold the Reset button  for 1-2 seconds to clear the alarm and reset the counter.

NOTE: The Pump Stall Test can only be reset by successfully completing the test.

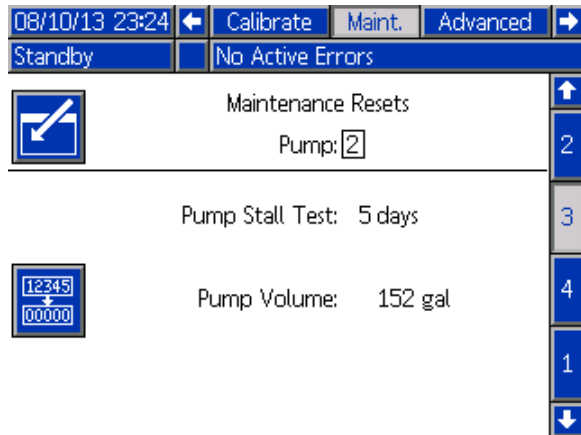



Figure 77 Maintenance Screen 3, Current Pump Status

Maintenance Screen 4

Maintenance screen 4 is used to manually relieve pump outlet pressure, or to configure automatic pressure relief.

NOTE: Pump outlet pressure relief is only available for pumps that have a dump valve (color change outlet valves).

To manually relieve pump outlet pressure, change the number to the desired pump and press the Relief softkey .

To set the system to automatically relieve pump outlet pressure, check the Autodump box and set the Pressure Limit. All applicable pumps, while in Standby, will briefly open the dump valves to relieve outlet pressure when the reading climbs above the set Pressure Limit. The system will attempt up to three times if the pressure does not drop below the set limit.

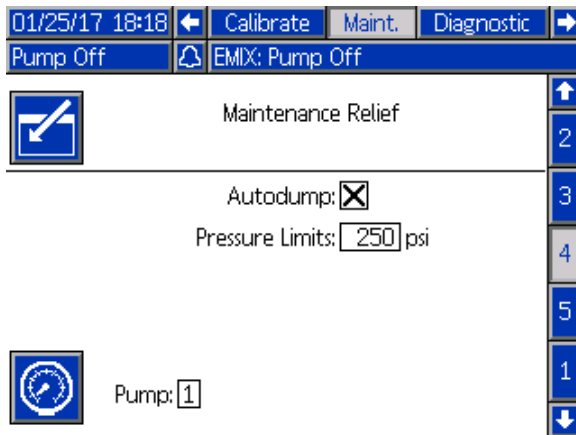



Figure 78 Maintenance Screen 4, Manual Pump Relief

Maintenance Screen 5

Maintenance screen 5 displays cycle counts for a selected color, catalyst, or solvent valve.

Press and hold the Reset button  for 1-2 seconds to reset the counter.

If the system is in Standby, valves can be opened or closed by selecting or deselecting the box for the corresponding valve. Leaving this screen will close all manually driven valves.

NOTE: Gun valves are available only if Mix at Wall is enabled on [System Screen 3, page 43](#).

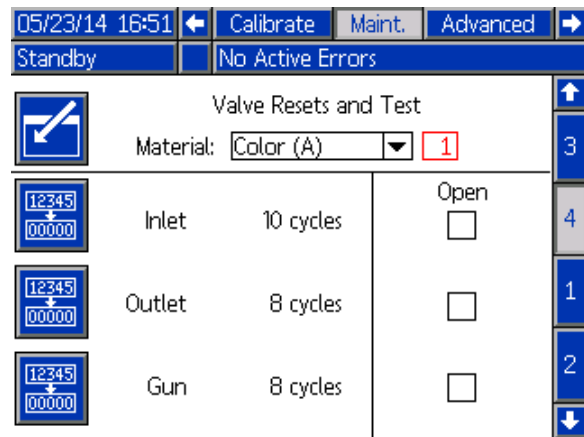

Figure 79 Maintenance Screen 5, Color Valve Resets

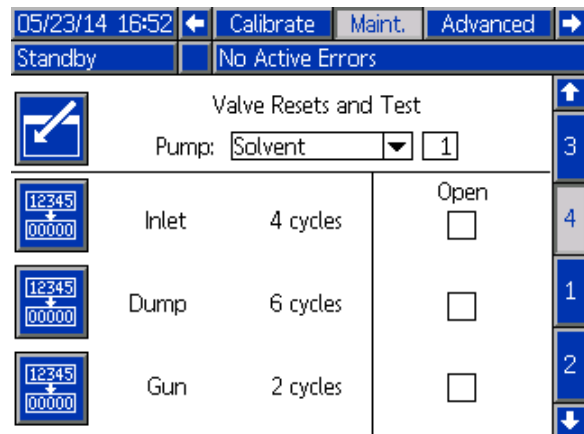

Figure 80 Maintenance Screen 5, Solvent Valve Resets

NOTE: When Solvent is selected in the Material field, the number to the right of "Solvent" is the pump number, not the material number.

Advanced Screen 1

Advanced screen 1 sets the following display parameters.

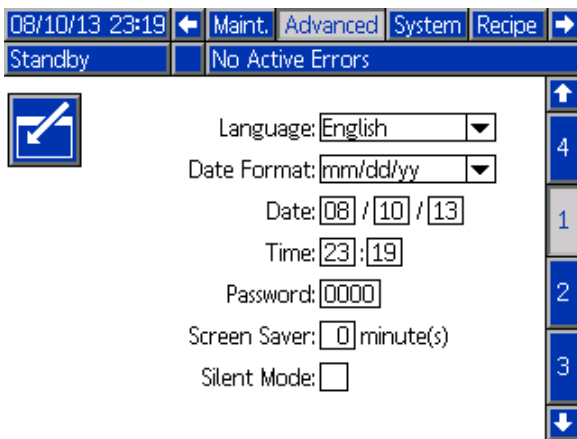

Figure 81 Advanced Screen 1

Language

Defines the language of the screen text. Select:

- English (default)
- Spanish
- French
- German
- Japanese
- Chinese
- Korean
- Dutch
- Italian
- Portuguese
- Swedish
- Russian

Date Format

Select mm/dd/yy, dd/mm/yy, or yy/mm/dd.

Date

Enter the date, using the format selected. Use two digits for the month, day, and year.

Time

Enter current time in hours (24 hour clock) and minutes. Seconds are not adjustable.

Password

The password is only used to enter Setup mode. The default is 0000, which means no password is required to enter Setup. If a password is desired, enter a number from 0001 to 9999.

NOTE: Be sure to write down the password and keep it in a secure location.

Screen Saver

Select the desired screen timeout in minutes (00-99). 5 is the default. Select zero (0) to disable the screen saver.

Silent Mode

Select Silent Mode to disable the alarm buzzer and audible feedback.

Advanced Screen 2

Advanced screen 2 sets display units (US or metric).

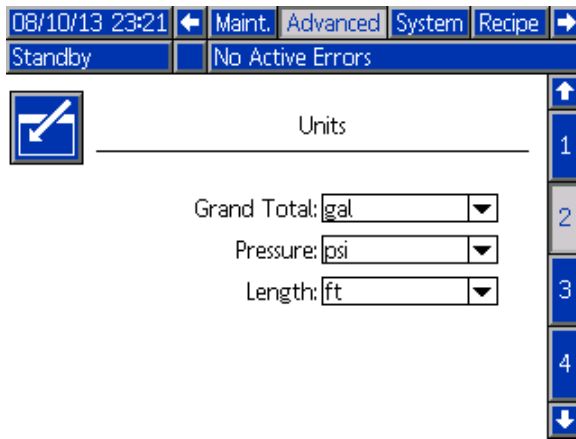

Figure 82 Advanced Screen 2

Display Units

Select the desired display units:

- Grand Total Volume (US gallon or liter)
- Pressure (psi, bar, or MPa)
- Length (ft or m)

Advanced Screen 3

Advanced screen 3 enables USB downloads and uploads.

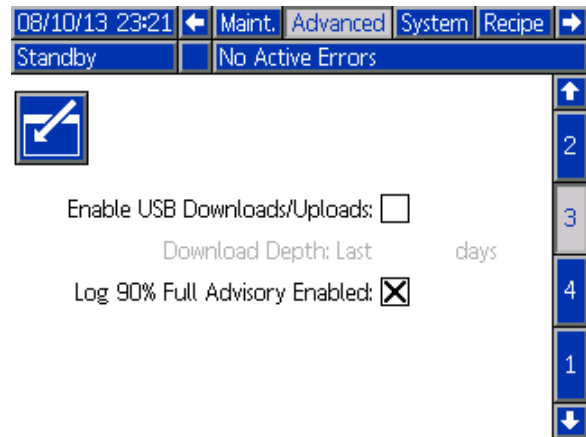

Figure 83 Advanced Screen 3

Enable USB Downloads/Uploads

Select this box to enable USB downloads and uploads. Enabling USB activates the Download Depth field.

Download Depth

Enter the number of days for which you want to retrieve data. For example, to retrieve data for the previous week, enter 7.

Log 90% Full Advisory Enabled

This selection is enabled by default. When enabled, the system will issue an advisory if the memory log has reached 90% of capacity. Perform a download to avoid loss of data.

Advanced Screen 4

Advanced screen 4 displays the software part numbers and versions for the system components. This is not an editable screen.

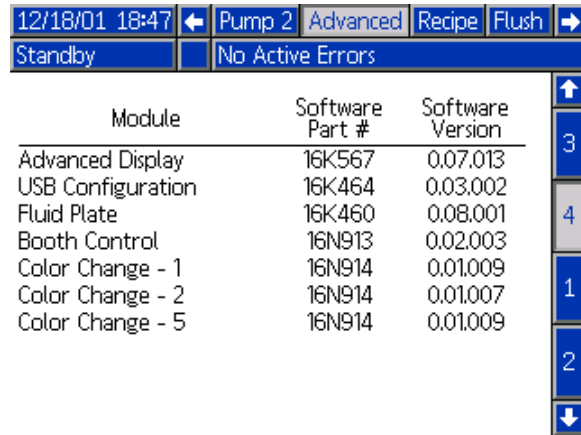

The screenshot shows a software interface with a top navigation bar containing '12/18/01 18:47', 'Pump 2', 'Advanced', 'Recipe', and 'Flush'. Below this is a status bar with 'Standby' and 'No Active Errors'. The main area contains a table with three columns: 'Module', 'Software Part #', and 'Software Version'. A vertical navigation bar on the right side has buttons labeled 1, 2, 3, and 4, with button 4 currently selected.

Module	Software Part #	Software Version
Advanced Display	16K567	0.07.013
USB Configuration	16K464	0.03.002
Fluid Plate	16K460	0.08.001
Booth Control	16N913	0.02.003
Color Change - 1	16N914	0.01.009
Color Change - 2	16N914	0.01.007
Color Change - 5	16N914	0.01.009

Figure 84 Advanced Screen 4

Diagnostic Screens

Diagnostic Screen 1

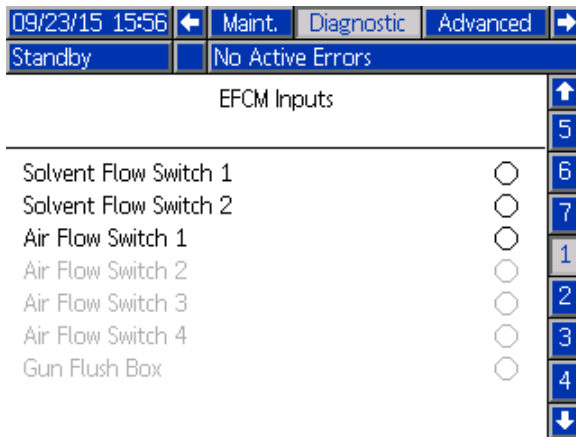

Use this screen to test and verify proper wiring for all inputs to the EFCM (see installation manual 332457 for details). The screen shows all available inputs to the EFCM, but only highlights those that are relevant to the system configuration. All inputs are normally open. When the input sees a switch closure the status indicator on the screen will turn green.

Diagnostic Screen 2

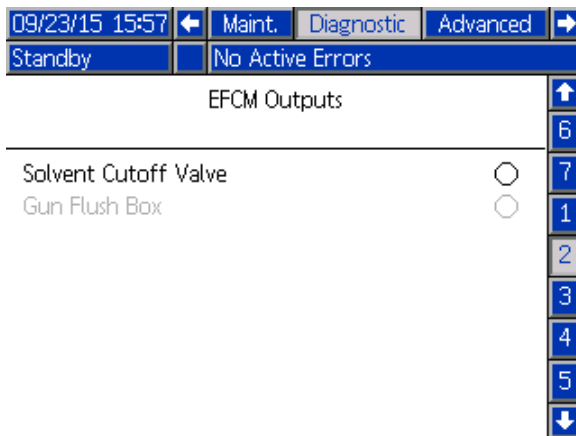

This screen can be used to determine if any of the EFCM outputs are currently on or off. The screen shows all available outputs from the EFCM, but only highlights those that are relevant to the system configuration. The status indicator next to each output indicates the output is ON when it is green.

Diagnostic Screens 3–10

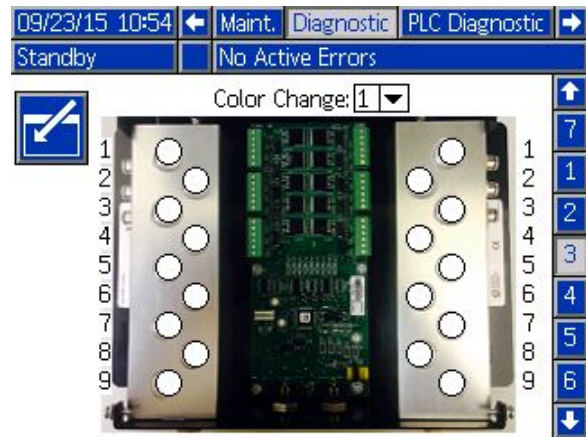

Diagnostic screens 3–10 are only available for color change modules that are currently connected to the PD2K system. These screens provide real time status of the color change valve outputs by changing the status indicator from white to green when the system energizes that solenoid. The user may scroll through the boards with the up and down arrows, or jump directly to a specific color change module by selecting it from the drop down box.

Calibration Checks

Pump Pressure Check

NOTE: Enter the transducer calibration data before doing the pressure check.

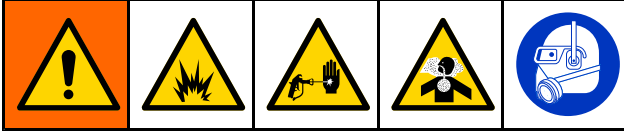

Perform the pressure check:

- The first time the system is operated.
- Whenever new materials are used in the system, especially if the materials have viscosities that differ significantly.
- At least once per month as part of regular maintenance.
- Whenever a pump is serviced or replaced.

During each pressure test, the dose valve will close during an up stroke and a down stroke (in either order). This test is to verify that the valves are seating properly and not leaking. If leaking occurs, the system will alarm after the test for that particular pump direction.

NOTE: Do not trigger the gun during the pressure check.

1. Set the mix manifold to the SPRAY position.

2. The pump and lines must be primed with color or catalyst before doing the Pressure Check. See [Prime and Fill the System, page 27](#).

3. If the display is on a Run Mode screen, press  to access setup screens.



4. Scroll to Calibrate to display [Calibrate Screen 1, page 63](#).

5. Press the Pressure Check  button for the desired pump. The pump will build pressure in the line to a minimum of the Stall Test Pressure. The pump will then move to the center stroke position and stall test the upstroke, followed by the downstroke.
6. The pressure and flow that the unit measured are displayed on the screen. Compare with the maximum leak rate entered on [System Screen 2, page 41](#). If the values are substantially different, repeat the test.

NOTE: The stall test pressure set point is a minimum. The system may stall at a higher pressure depending on hose lengths and fluid composition.

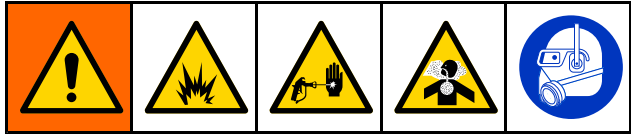
Pump Volume Check



1. Set the mix manifold to the SPRAY position.
2. The pump and lines must be primed with color or catalyst before doing the Volume Check. See [Prime and Fill the System, page 27](#).
3. If the display is on a Run Mode screen, press  to access setup screens.
4. Scroll to Calibrate in the menu bar.
5. Scroll to [Calibrate Screen 2, page 64](#).
6. Press the soft key  for the pump you want to check.

NOTE: For maximum accuracy, use a gravimetric (mass) method to determine the actual volumes dispensed. Verify that the fluid line is filled and at the proper pressure before checking. Air in the line or pressure that is too high may cause incorrect values.





7. Press the Reset key . The volume counter will reset to 0.
8. Trigger the gun into a graduated cylinder. Dispense a minimum of 500cc of material.
9. The volume that the unit measured displays on the screen.
10. Compare the amount on the screen to the amount in the graduated cylinder.

NOTE: If the value is substantially different, repeat the test. If the dispensed volume and measured volume still do not match, check that the A and B pump positions are not reversed.

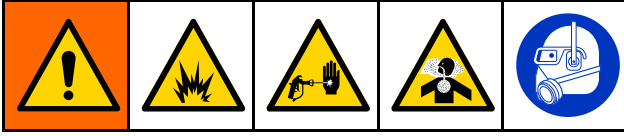
NOTE: Stop triggering the gun and press  to cancel the test.

Solvent Meter Calibration



1. Set the mix manifold to the FLUSH position.
2. The meter and lines must be primed with solvent before doing the calibration. See [Prime and Fill the System, page 27](#).
3. If the display is on a Run Mode screen, press  to access setup screens.
4. Scroll to Calibrate in the menu bar.
5. Scroll to [Calibrate Screen 3, page 65](#).
6. Press the soft key  to initiate the calibration.
NOTE: For maximum accuracy, use a gravimetric (mass) method to determine the actual volumes dispensed.
NOTE: Verify that the fluid line is filled and at the proper pressure before calibrating. Air in the line or pressure that is too high may cause incorrect calibration values.
7. Trigger the gun into a graduated cylinder. Dispense a minimum of 500cc of material.
8. The volume that the unit measured displays on the screen.
9. Compare the amount on the screen to the amount in the graduated cylinder.
NOTE: If the value is substantially different, repeat the calibration process.
10. Enter the amount of solvent dispensed in the Measured Volume field on the screen.
11. After the measured volume is entered, the controller calculates the new solvent meter K-factor and displays it on the screen. The standard meter K-factor is 0.021 cc/pulse.
12. Press  to accept the calibration. Press  to cancel the calibration and retain the previous K-factor.

Color Change

Color Change Module Kits are available as an accessory. See manual 332455 for complete information.

Single Color Systems

1. Follow the procedure under [Flush the System, page 30](#).
2. Load the new color. See [Prime and Fill the System, page 27](#).
3. Press the Mix key  to start spraying.

Multiple Color Systems

1. Press Standby .
2. Set the current mix manifold to FLUSH.
3. Select the new recipe at the Booth Control or on the [Spray Screen, page 35](#). This will change colors in the pump and initiate a gun purge. The Standby and Purge indicators should be blinking.

NOTE: The booth control only displays enabled recipes. If an invalid recipe is entered, the display will show 4 dashes (— — — —). See [Recipe Screen, page 50](#) to enable a recipe.

NOTE: If Mix at Wall is enabled on [System Screen 3, page 43](#), the system will purge Material B first, then Material A out of the gun. Each material will purge for the amount of time designated by the Flush Sequence selected for that material on the [Recipe Screen, page 50](#).
4. Hold a metal part of the gun firmly to a grounded metal pail. Trigger the gun. Make sure there is enough flow to open the solvent flow switch.
5. Release the trigger when the solvent flow stops and the Purge indicator stops blinking.

NOTE: If you are using quick-disconnects at the mix manifold, disconnect the gun from the purged mix manifold and connect it to the new color line.
6. Wait for the color change to complete (the Standby indicator is on solid).
7. Set the mix manifold to SPRAY.
8. Press the Mix key  on the booth control. The Mix indicator will be blinking.
9. Trigger the gun to complete the Mix Fill.

NOTE: There is a 30 second delay without flow before the system will fault.
10. Wait for atomizing air and for the Mix indicator to be on solid, then resume spraying.

System Errors

System errors alert you of a problem and help prevent off-ratio spraying. There are three types: Advisory, Deviation, and Alarm.

An **Advisory** records an event in the system, and will clear itself after 60 seconds. The four digit error code will be followed by “-V”.

A **Deviation** records an error in the system but does not shut down the equipment. The deviation must be acknowledged by the user. The four digit code will be followed by “-D”.

If an **Alarm** occurs, operation stops. The four digit error code will be followed by “-A”.

If any of the system error types occur:

- Alarm buzzer sounds (unless in silent mode).
- Alarm popup screen shows the active alarm code (see [Error Codes, page 78](#)).
- Status bar on the Advanced Display Module shows the active alarm code.
- Alarm is saved in the date/time stamped log.

A **Record** saves relevant system events in the background. These are informational only and can be reviewed on the Events screen which displays the 200 most recent events, with date, time, and description.

On-Screen Help

When a system alarm occurs, a help screen is available to provide timely and relevant troubleshooting information for the user. On the

alarm popup screen, press  to access the help screens. The help screens may also be accessed at any time by going to the Errors Screen and selecting an alarm in the log (see [Errors Screen, page 38](#)).

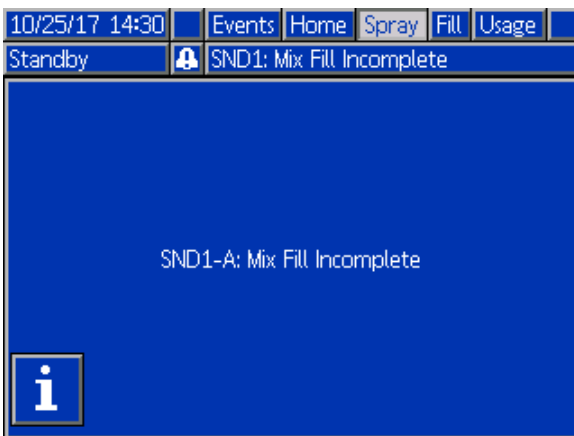



Figure 85 Alarm Popup Screen

All alarms have a QR code screen. A mobile device with internet access and a QR reader may use the QR code to access additional information on a webpage hosted by help.graco.com.



Figure 86 Error QR Code Screen

A number of the alarms that are most likely to be encountered during typical operation have detailed troubleshooting information screens. The troubleshooting screens will replace the QR code screen, though the QR code may still be accessed by

pressing .

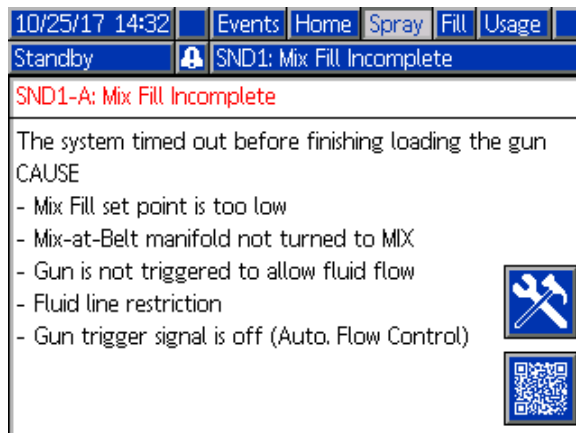

Figure 87 Error Troubleshooting Screen

To Clear Error and Restart

NOTE: When a deviation or alarm occurs, be sure to determine the error code before resetting it. If you forget which code occurred, go to the [Errors Screen, page 38](#), to view the last 200 errors, with date and time stamps.

If an alarm has occurred, correct the cause before resuming operation.

To acknowledge a deviation or clear an alarm, press



on the Advanced Display Module or  on the Booth Control.

Air Flow Switch (AFS) Function

The air flow switch (AFS) detects air flow to the gun and signals the controller when the gun is triggered. The gun icon on the Advanced Display Module shows spray when the AFS is activated.

If a pump fails, pure resin or catalyst could spray indefinitely if the unit does not detect the condition and intervene, which is why the AFS is so important.

If the unit detects through the AFS signal that the gun is triggered, yet one or both of the pumps are not running, a Flow Not Detected Alarm (F8D1) occurs after 10 seconds (default) and the system goes into Standby.

Error Codes

NOTE: When an error occurs be sure to determine the code before resetting it. If you forget which code occurred, use the [Errors Screen, page 38](#) to view the last 200 errors, with date, time, and description.

Purge Errors

Code	Type	Description	Problem	Cause	Solution
ETD1	Deviation	Autodump Color (A) Passed	System has completed an auto dump of the contents from the pump all the way out to the gun.	Potlife time has expired and the system was not purged, so the system refilled with color.	No action required.
ETE0	Record	Purge Not Complete	The system was unable to complete a purge sequence.	An indication that the system either could not complete or was interrupted before completing a gun purge.	No action required.
ET01	Alarm	Autodump Failed	Potlife time has expired and the system attempted to flush the mixed material contents out of the gun. The solvent flow meter or solvent flow switch did not indicate any flow taking place during the attempted purge.	Solvent flow switch not working.	Replace the switch.
				Gun is not in gun flush box.	Ensure that the gun is replaced in the gun flush box and cover is closed when not in use.
ETS1	Deviation	Autodump Solvent Passed	System has completed an auto dump of the gun contents only.	Potlife time has expired and the system was not purged, so the system performed an autodump with solvent.	No action required.
F7P1	Alarm	Air Flow Switch On	The air flow switch is indicating unexpected atomizing air flow.	Air flow switch is stuck in flow position.	Clean or replace switch.
				Leak downstream in air line or fitting.	Check for leaks and tighten fittings.
				Air supply pressure fluctuation.	Eliminate pressure fluctuations.
SGD1	Alarm	Gun Flush Box Open	GFB was left open when the system was trying to attempt a purge.	Gun is not in gun flush box.	Ensure the gun is replaced in the gun flush box and cover is closed when not in use.
				GFB pressure switch not wired/working.	Double check that the pressure switch is wired properly to the EFCM.

Code	Type	Description	Problem	Cause	Solution
SPD1	Alarm	Gun Purge Incomplete	The system timed out without reaching the user-specified volume of solvent for a purge.	Solvent flow switch not working.	Replace switch.
				Solvent flow is too low to actuate the solvent switch.	Increase solvent pressure to drive a high purge flow rate
				Gun is not triggered.	Operator must continue flushing for configured time, until the booth control indicates purge is completed.
				Mix manifold was not set to flush position, blocking solvent flow to the spray gun.	Set manifold to flush position.

System Errors

Mix Errors

Code	Type	Description	Problem	Cause	Solution
F7S1	Alarm	Flow Detected Solvent Gun	The solvent flow switch is indicating unexpected solvent flow.	Solvent flow switch is stuck in flow position.	Clean or replace switch.
				There is a leak through the solvent cutoff valve.	Check for leaks and repair valve.
F7S2	Alarm	Flow Detected Solvent Mix	The solvent flow switches indicate that both are flowing solvent at the same time. *This only applies to systems with mix-at-wall.	One or both solvent flow switches are stuck in flow position.	Clean or replace the switch(es).
				There is a leak through one or both of the solvent cutoff valves.	Check for leaks and repair valve(s).
QPD1	Alarm, then Deviation	Potlife Expired	Potlife time has expired before the system has moved the required amount of material (potlife volume) through the mixed material line.	Purge process was not completed.	Make sure purge process is completed.
				Solvent supply shut off or empty.	Verify solvent supply is available and on, supply valves are open.
QP##	Deviation	Potlife Expired Recipe ##	Potlife time has expired before the system has moved the required amount of material (potlife volume) through the mixed material line in an inactive gun loaded with recipe ##. *This only applies to systems with multiple guns.	An inactive gun has mixed material for recipe ## loaded and has not dispensed enough material in the required amount of time.	Purge the inactive gun.
SND1	Alarm	Mix Fill Incomplete	The system timed out before the mix fill cycle loaded the gun with mixed material.	Mix manifold not set to spray position.	Set manifold to spray.
				Spray gun was not triggered.	Allow flow through gun during fill process until the fill complete LED stops flashing.
				Restrictions in mixer, manifold, or spray gun.	Fix restrictions.

Pumping Errors

NOTE: In some error codes listed below, a # symbol is shown as the last digit. This symbol represents the applicable component number, which can vary. The unit's display will show the applicable number as the last digit in the code. For example, the F1S# code listed in this table will be displayed as F1S1 if the affected component is pump 1, F1S2 for pump 2, and so on.

Code	Type	Description	Problem	Cause	Solution
DA0#	Alarm	Exceeded Maximum Flow Pump #	Pump was driven to its maximum allowed speed.	System has a leak or open valve that is allowing unrestricted flow.	Inspect system for leaks.
				Pump is cavitating, cycling without restriction.	Verify that the pump is being supplied with material.
				Viscosity of material is too thin for nozzle size.	Reduce nozzle size to create more restriction. Reduce paint pressure to lower the flow rate.
				System pressure or Flow Setpoint is too high (causing the pump to work too hard).	Reduce the pressure or the Flow Setpoint.
DE0#	Alarm	Leak Detected Pump #	This is a manual stall test failure when the pump cannot build pressure to the target "Stall Test Pressure." Will fault after 30 seconds.	No material in the pump or line.	Make sure the pump and down stream color line are loaded with material.
				Leak in the system.	Determine if leak is external or internal by visually inspecting the system for fluid leakage. Fix all loose or worn hoses, fittings, and seals. Inspect all valve seats and needles for wear, and replace worn piston or throat seals.
DF0#	Alarm	No Stall Up Pump #	Pump failed the stall test; did not stall on the upstroke.	Valve failure, seal failure, worn rod or cylinder.	Replace inlet and outlet valve and seal for up stroke. Replace piston and throat seals. Replace rod and cylinder as necessary.
DG0#	Alarm	No Stall Down Pump #	Pump failed the stall test; did not stall on the downstroke.	Valve failure, seal failure, worn rod or cylinder.	Replace inlet and outlet valve and seal for down stroke. Replace piston and throat seals. Replace rod and cylinder as necessary.

System Errors

Code	Type	Description	Problem	Cause	Solution
DH0#	Alarm	No Stall Pump #	Pump failed the stall test; did not stall on either the upstroke or the downstroke.	Valve failure, seal failure, worn rod or cylinder.	Replace inlet and outlet valve and seal for up and down strokes. Replace piston and throat seals. Replace rod and cylinder as necessary.
DKD#	Alarm	Position Failed Pump #	Pump was unable to reach its drive position.	Not enough air is supplied to the dosing valves.	Ensure that at least 85 PSI is being supplied to the dosing valves.
				The pressure at the pump outlet is too high.	Check for an obstruction downstream of the pump that would increase pressure. Ensure the feed pressure is within 1/2 - 1/3 of the target pressure.
DKF#	Alarm	Position Overspeed Pump #	Pump moved beyond its drive position.	The pump was knocked out of position.	There is not fluid pressure at the outlet of the pump. Run the pump at a lower pressure to fill the lines. Check that the feed pressure is not more than 1/2 – 1/3 greater than the target pressure.
EBH#	Record	Home Complete Pump #	Record of pump homing is complete.	An indication on the display that the pump completed the home function	No action required.
EF0#	Alarm	Timeout Startup Pump #	Pump tried but was not able to move to the home position within a specified amount of time.	Pump dose valves did not actuate.	Verify air pressure to solenoid valves. Verify the valves are actuating.
				Motor could not drive pumps and linear actuator.	Verify motor is driving the pump.
				Pump stroke length is shortened by mechanical system tolerance.	Verify correct assembly of linear actuator and pump piston rods. See pump manual.

Code	Type	Description	Problem	Cause	Solution
EF1#	Alarm	Timeout Shutdown Pump #	Pump tried but was not able to move to the park position within a specified amount of time.	Pump dose valves did not actuate.	Visually inspect valves to ensure they are operating properly; verify they have air pressure above 85 psi (0.6 MPa, 6.0 bar).
				Pump is filled with thick paint and could not drive piston to end of stroke. Motor or drive is worn or damaged.	Observe motor and drive assembly to verify that the motor is generating force.
ETD#	Record	Auto Pressure Relief Pump #	Record of pump completing an auto pressure relief.	Pump outlet pressure exceeded relief threshold.	No action required.
F1F#	Alarm	Flow Low Fill Pump #	There has been no flow or low flow during a pump fill operation.	There is a restriction on the outlet side of the pump or color stack.	Make sure there are no restrictions in the color stack and that the dump valve is actuating.
				Thick viscosity paint requires more pressure to pump.	Increase non-mix pressure if necessary to create flow during the fill function.
				The pumps do not have to move for the system to build enough pressure to meet the setpoint.	Increase non-mix pressure if necessary to create flow during the fill function.
F1S#	Alarm	Flow Low Purge Pump #	There has been no flow or low flow during a pump purge operation.	Restriction in the outlet side of the pump or color stack resulting in the solvent flow being too low.	Make sure there are no restrictions in the system. Increase non-mix pressure if necessary to create flow during the purge function.
F7D#	Alarm	Flow Detected Pump #	The pump flow exceeded 20 cc/min flow coming into Idle mode.	There is a leak in the system or the gun was open when the system went into Idle mode.	Verify there are no leaks in the system. Make sure the air flow switch is actuating properly. Do not trigger the gun without atomizing air.
F8D1	Alarm	Flow Not Detected	No flow while mixing.	Restriction in the outlet side of the pump or color stack.	Make sure there are no restrictions in the system.

System Errors

Code	Type	Description	Problem	Cause	Solution
F9D#	Alarm	Flow Unstable Pump #	The pump flow rate did not stabilize while entering Idle mode.	Potential leak in the system.	Check the system for leaks and run manual stall test.
SAD1	Alarm	Atomizing Solvent	Air flow switch is active while solvent, diluted material, or an unknown material is in the gun.	Atomizing air supply was not shut off before purging or filling spray gun.	Make sure atomizing air is shut off before purging or filling the spray gun. Use an AA cutoff valve on the atomizing air supply.

Pressure Errors

NOTE: In some error codes listed below, a # symbol is shown as the last digit. This symbol represents the applicable component number, which can vary. The unit's display will show the applicable number as the last digit in the code. For example, the P6F# code listed in this table will be displayed as P6F1 if the affected component is pump 1, P6F2 for pump 2, and so on.

Code	Type	Description	Problem	Cause	Solution
P1F#	Alarm	Pressure Low Inlet Pump #	The inlet pressure on pump # is less than the user-entered alarm limit.		Increase inlet pressure.
P2F#	Deviation	Pressure Low Inlet Pump #	The inlet pressure on pump # is less than the user-entered deviation limit.		Increase inlet pressure.
P3D#	Deviation	Pressure High Outlet Pump #	The outlet pressure on pump # is greater than the user entered deviation limit.		Relieve system pressure.
P3F#	Deviation	Pressure High Inlet Pump #	The inlet pressure on pump # is greater than the user-entered deviation limit.		Decrease inlet pressure.
P4D#	Alarm	Pressure High Outlet Pump #	The outlet pressure on pump # is greater than the user entered alarm limit.		Relieve system pressure.
P4F#	Alarm	Pressure High Inlet Pump #	The inlet pressure on pump # is greater than the user-entered alarm limit.		Decrease inlet pressure.
P4P#	Alarm	Pressure High Supply Pump #	The supply pump fluid pressure for pump # is greater than 90% of the user-entered Stall Test Pressure.	The supply pump pressure is too high.	Check supply for pump #, decrease supply pressure.
P6D#	Alarm	Press. Sens. Removed Outlet #	No outlet pressure transducer is detected when the system is expecting one.	Disconnected transducer.	Verify transducer is connected properly. Replace if reconnecting does not eliminate the alarm.
P6F#	Alarm	Press. Sens. Removed Inlet #	No inlet pressure transducer is detected when the system is expecting one.	Disconnected transducer.	Verify transducer is connected properly. Replace if reconnecting does not eliminate the alarm.
P9D#	Alarm	Press. Sens. Failed Outlet #	Outlet pressure transducer has failed.	Outlet pressure transducer has failed or the pressure is above the readable range.	Relieve system pressure. Verify connections, or replace if reconnecting does not eliminate the alarm.

System Errors

Code	Type	Description	Problem	Cause	Solution
P9F#	Alarm	Press. Sens. Failed Inlet #	Inlet pressure transducer has failed.	Inlet pressure transducer has failed or the pressure is above the readable range.	Relieve system pressure. Verify connections, or replace if reconnecting does not eliminate the alarm.
QADX	Alarm	Differential Pressure A Over B	Low differential pressure. This alarm is active only during Mix mode.	There is a leak on the B side.	Check the system for internal and external leaks on all catalyst manifolds and plumbing.
				The B side pump is cavitating.	Check paint supply on the B side, increase paint supply pressure.
QBDX	Alarm	Differential Pressure B Over A	High differential pressure. This alarm is active only during Mix mode.	There is a leak on the A side.	Check the system for internal and external leaks on all color manifolds and plumbing.
				The A side pump is cavitating.	Check paint supply on the A side, increase paint supply pressure.

System Errors

Code	Type	Description	Problem	Cause	Solution
EB00	Record	Stop Button Pressed	Record of a stop button press.	Indicates system stop key on ADM was pressed.	n/a
EBIX	Record	Power Button Pressed	Record of pumps powered off by button press.	The power button on the ADM was used to shut down pump power.	No action required.
EC00	Record	Setup Value(s) Changed	Record of changing setup variables.	Indicates date and time when setup values were changed.	n/a
EL00	Record	System Power On	Record of power cycle (ON).	Indicates date and time when system was started.	n/a
EM00	Record	System Power Off	Record of power cycle (OFF).	Indicates date and time when system was turned off.	n/a
EMIX	Advisory	Pump Off	The pumps are not powered and are unable to move.	Pump power was turned off or an error occurred.	Start pumps by pressing pump start key on Advanced Display module.
EP0X	Record	Auto Pump Parked	Record of pumps being auto parked.	The auto park operation was completed.	No action required.
ES00	Advisory	Factory Defaults	Record of defaults being loaded.		n/a
WSN1	Alarm	Config Error Color	A color defined for the system is not assigned to any gun. *This only applies to systems with multiple guns.	One or more colors is missing a valid gun assignment.	Ensure all colors for all color pumps have a gun assigned to them on Pump Screen 4.
WSN2	Alarm	Config Error Catalyst	A catalyst defined for the system has an invalid gun assignment. *This only applies to systems with multiple guns.	One or more catalyst is missing a valid gun assignment.	Ensure all catalysts for all catalyst pumps have a gun assigned to them on Pump Screen 4.
				Too many catalyst gun assignments exist.	The total number of catalyst gun assignments for the system may not exceed four.

System Errors

Communication Errors

NOTE: In some error codes listed below, a # symbol is shown as the last digit. This symbol represents the applicable component number, which can vary. The unit's display will show the applicable number as the last digit in the code. For example, the CAC# code listed in this table will be displayed as CAC1 if the affected component is color change board 1, CAC2 for board 2, and so on.

Code	Type	Description	Problem	Cause	Solution
CA0X	Alarm	Comm. Error ADM	System does not detect the Advanced Display Module (ADM).	This communication error indicates that the Network has lost communication with the Advanced Display Module.	Check CAN cable connecting ADM to the EFCM.
CAC#	Alarm	Comm. Error Color Change #	System does not detect the Color Change Module #.	This communication error indicates that the network has lost communication with the Color Change Module #.	Check CAN cable connections to the Color Change Module # and any interconnected modules.
CADX	Alarm	Comm. Error Fluid Module	System does not see the Enhanced Fluid Control Module (EFCM).	This communication error indicates that the Network has lost communication with the EFCM.	Check CAN cables connecting ADM to the EFCM. Replace Cable or EFCM as necessary.
CAGX	Alarm	Comm. Error Gateway	System does not detect a CGM that was registered as being connected at power up.		
CAG#	Alarm	Comm. Error Modbus Gateway	System does not detect a Modbus CGM that was registered as being connected at power up.	The Modbus CGM address dial was changed while the system was powered up.	Unplug the Modbus CGM from the CAN network and re-plug it back in so that it re-registers with the new address.
				The Modbus CGM is not connected/failed.	Check that the Modbus CGM is properly connected to the CAN network and it's LEDs indicate it is powered.
CANX	Alarm	Comm. Error Booth Control	System does not detect the Booth Control Module.	This communication error indicates that the network has lost communication with the Booth Control.	Check CAN cable connecting the Booth Control to the network.
CDC#	Alarm	Duplicate Color Change #	System detects two or more identical Color Change Modules.	More than one Color Change Module with the same address is connected in the system .	Check the system and remove the extra color change module.

Code	Type	Description	Problem	Cause	Solution
CDDX	Alarm	Duplicate Fluid Module	System sees two or more identical Enhanced Fluid Control Modules (EFCM).	More than one EFCM is connected in the system.	Check the system and remove the extra EFCM.
CDNX	Alarm	Duplicate Booth Control	System detects two or more identical Booth Control Modules.	More than one Booth Control Module is connected in the system.	Remove the extra Booth Control Module.

System Errors

USB Errors

Code	Type	Description	Problem	Cause	Solution
EAUX	Advisory	USB Busy	USB drive is inserted, download is in progress.	Indicates USB port is uploading or downloading data.	Wait for USB Idle.
EBUX	Record	USB Drive Removed	USB drive was removed while downloading or uploading.	Downloading/uploading data on USB was interrupted by the USB device being removed.	Replace the USB device and begin process again.
EQU0	Advisory	USB Idle	USB download completed, drive may be removed.	Data transfer is completed to the USB device.	Remove USB device from ADM.
EQU1	Record	USB Sys. Settings Downloaded	Settings were downloaded to USB drive.	User installed USB device in ADM USB port.	n/a
EQU2	Record	USB Sys. Settings Uploaded	Settings were uploaded from USB drive.	User installed USB device in ADM USB port.	n/a
EQU3	Record	USB Custom Lang. Downloaded	Custom language was downloaded to USB drive.	User installed USB device in ADM USB port.	n/a
EQU4	Record	USB Custom Lang. Uploaded	Custom language was uploaded from USB drive.	User installed USB device in ADM USB port.	n/a
EQU5	Record	USB Logs Downloaded	Data logs were downloaded to USB drive.	User installed USB device in ADM USB port.	n/a
EVUX	Advisory	USB Disabled	USB drive has been inserted, downloading is disabled.	Configuration of system is blocking data transfer.	Change configuration to enable USB download function.
MMUX	Advisory	Maint. USB Logs Full	USB memory is more than 90% full.	Configuration parameter on system is enabled to generate this advisory.	Complete download to ensure no data is lost.
WSUX	Advisory	USB Config. Err.	USB configuration file does not match expected; checked on startup.	A software update was not completed successfully.	Reinstall software.
WXUD	Advisory	USB Download Err.	An error occurred while downloading to the USB drive.	User installed incompatible USB device in ADM USB port.	Repeat process with compatible USB device.
WXUU	Advisory	USB Upload Err.	An error occurred while uploading from the USB drive.	User installed incompatible USB device in ADM USB port.	Repeat process with compatible USB device.

Miscellaneous Errors

NOTE: In some error codes listed below, a # symbol is shown as the last digit. This symbol represents the applicable component number, which can vary. The unit's display will show the applicable number as the last digit in the code. For example, the B9D# code listed in this table will be displayed as B9D1 if the affected component is pump 1, B9D2 for pump 2, and so on.

Code	Type	Description	Problem	Cause	Solution
B9A0	Advisory	Volume Rollover A Current	Batch counter for material A rolled over.	The totalizer has reached maximum capable value and started over at zero.	n/a
B9AX	Advisory	Volume Rollover A Lifetime	Grand total counter for material A rolled over.	The totalizer has reached maximum capable value and started over at zero.	n/a
B9B0	Advisory	Volume Rollover B Current	Batch counter for material B rolled over.	The totalizer has reached maximum capable value and started over at zero.	n/a
B9BX	Advisory	Volume Rollover B Lifetime	Grand total counter for material B rolled over.	The totalizer has reached maximum capable value and started over at zero.	n/a
B9D#	Advisory	Volume Rollover Pump #	Grand total counter for pump # rolled over.	The totalizer has reached maximum capable value and started over at zero.	n/a
B9S0	Advisory	Volume Rollover Solvent Current	Batch counter for solvent rolled over.	The totalizer has reached maximum capable value and started over at zero.	n/a
B9SX	Advisory	Volume Rollover Solvent Lifetime	Grand total counter for solvent rolled over.	The totalizer has reached maximum capable value and started over at zero.	n/a
WX00	Alarm	Software Errors	An unexpected software error has occurred.		Call Graco technical support.

Calibration Errors

NOTE: In some error codes listed below, a # symbol is shown as the last digit. This symbol represents the applicable component number, which can vary. The unit's display will show the applicable number as the last digit in the code. For example, the ENT# code listed in this table will be displayed as ENT1 if the affected component is pump 1, ENT2 for pump 2, and so on.

Code	Type	Name	Description
END#	Record	Calibration Pump #	A calibration test was run on the pump.
ENS0	Record	Calibration Solvent Meter	A calibration test was run on the solvent meter.
ENT#	Record	Calibration Stall Test Pump #	A stall test was completed successfully on pump #.

System Errors

Maintenance Errors

NOTE: In some error codes listed below, a # symbol is shown as the last digit. This symbol represents the applicable component number, which can vary. For example, the MAD# code listed in this table will be displayed as MAD1 if the affected component is pump 1, MAD2 for pump 2, and so on.

Because some components are assigned a 2-digit number, the last digit of the code is displayed as an alphanumeric character. The second table below correlates the alphanumeric digit to its component number. For example, code MEDZ represents outlet valve 30.

Code	Type	Name	Description
MAD#	Advisory	Maint. Outlet Pump #	Maintenance is due on pump.
MAT#	Advisory	Maint. Stall Test Pump #	Maintenance stall test is due on pump.
MEB#	Advisory	Maint. Valve Catalyst (B) #	Maintenance is due on catalyst valve.
MED#	Advisory	Maint. Valve Outlet #	Maintenance is due on outlet valve.
MEF#	Advisory	Maint. Valve Inlet #	Maintenance is due on inlet valve.
MEG#	Advisory	Maint. Valve Gun #	Maintenance is due on gun valve.
MEN#	Advisory	Main. Valve Auxiliary	Maintenance is due on auxiliary valve.
MES#	Advisory	Maint. Valve Solvent #	Maintenance is due on solvent valve.
MFF#	Advisory	Maint. Meter Flow #	Maintenance is due on flow meter.
MFS0	Advisory	Maint. Meter Solvent	Maintenance stall test is due on solvent meter.
MGH0	Advisory	Maint. Filter Fluid	Maintenance is due on fluid filter.
MGP0	Advisory	Maint. Filter Air	Maintenance is due on air filter.
MJP#	Advisory	Maint. Valve Air	Maintenance is due on air valve.

Alphanumeric Last Digits

Alphanumeric Digit	Component Number
1	1
2	2
3	3
4	4
5	5
6	6
7	7
8	8
9	9
A	10
B	11
C	12
D	13
E	14
F	15

Alphanumeric Digit	Component Number
G	16
H	17
J	18
K	19
L	20
M	21
N	22
P	23
R	24
T	25
U	26
V	27
W	28
Y	29
Z	30

Maintenance

Preventive Maintenance Schedule

The operating conditions of your particular system determine how often maintenance is required. Establish a preventive maintenance schedule by recording when and what kind of maintenance is needed, and then determine a regular schedule for checking your system.

Flushing

- Flush before changing fluids, before fluid can dry in the equipment, at the end of the day, before storing, and before repairing equipment.
- Flush at the lowest pressure possible. Check connectors for leaks and tighten as necessary.
- Flush with a fluid that is compatible with the fluid being dispensed and the equipment wetted parts.

Cleaning the ADM

Use any alcohol-based household cleaner, such as glass cleaner, to clean the ADM.

Technical Data

Positive Displacement Proportioner	U.S.	Metric
Maximum fluid working pressure:		
MC0500 Systems with Low-Pressure Pumps	300 psi	2.1 MPa, 21 bar
MC0500 Systems with High-Pressure Pumps	1500 psi	10.5 MPa, 105 bar
MC1000 and MC3000 Air Spray Systems	300 psi	2.1 MPa, 21 bar
MC2000 and MC4000 Air-Assisted Spray Systems	1500 psi	10.5 MPa, 105 bar
Maximum working air pressure:	100 psi	0.7 MPa, 7.0 bar
Air supply:	85–100 psi	0.6–0.7 MPa, 6.0–7.0 bar)
Air filter inlet size:	3/8 npt(f)	
Air filtration for air logic (user-supplied):	5 micron (minimum) filtration required; clean and dry air	
Air filtration for atomizing air (user-supplied):	30 micron (minimum) filtration required; clean and dry air	
Mixing ratio range:	0.1:1 — 50:1, ±1%	
Fluids handled:	one or two component: <ul style="list-style-type: none"> • solvent and waterborne paints • polyurethanes • epoxies • acid catalyzed varnishes • moisture sensitive isocyanates 	
Viscosity range of fluid:	20–5000 centipoise	
Fluid filtration (user-supplied):	100 mesh minimum	
Maximum fluid flow:	800 cc/minute (depending on material viscosity)	
Fluid outlet size:	1/4 npt(m)	
External power supply requirements:	90 - 250 Vac, 50/60 Hz, 7 amps maximum draw 15 amp maximum circuit breaker required 8 to 14 AWG power supply wire gauge	
Operating temperature range:	36 to 122°F	2 to 50°C
Storage temperature range:	–4 to 158°F	–20 to 70°C
Weight (approximate):	195 lb	88 kg
Sound data:	Less than 75 dB(A)	
Wetted parts:		
MC0500	Pumps sold separately; see selected pump manual for wetted parts information.	

Positive Displacement Proportioner	U.S.	Metric
MC1000 and MC2000	17-4PH, 303, 304 SST, Tungsten carbide (with nickel binder), perfluoroelastomer; PTFE, PPS, UHMWPE	
MC3000 and MC4000	316 SST, 17-4PH SST, PEEK, perfluoroelastomer; PTFE, PPS, UHMWPE	

Graco Standard Warranty

Graco warrants all equipment referenced in this document which is manufactured by Graco and bearing its name to be free from defects in material and workmanship on the date of sale to the original purchaser for use. With the exception of any special, extended, or limited warranty published by Graco, Graco will, for a period of twelve months from the date of sale, repair or replace any part of the equipment determined by Graco to be defective. This warranty applies only when the equipment is installed, operated and maintained in accordance with Graco's written recommendations.

This warranty does not cover, and Graco shall not be liable for general wear and tear, or any malfunction, damage or wear caused by faulty installation, misapplication, abrasion, corrosion, inadequate or improper maintenance, negligence, accident, tampering, or substitution of non-Graco component parts. Nor shall Graco be liable for malfunction, damage or wear caused by the incompatibility of Graco equipment with structures, accessories, equipment or materials not supplied by Graco, or the improper design, manufacture, installation, operation or maintenance of structures, accessories, equipment or materials not supplied by Graco.

This warranty is conditioned upon the prepaid return of the equipment claimed to be defective to an authorized Graco distributor for verification of the claimed defect. If the claimed defect is verified, Graco will repair or replace free of charge any defective parts. The equipment will be returned to the original purchaser transportation prepaid. If inspection of the equipment does not disclose any defect in material or workmanship, repairs will be made at a reasonable charge, which charges may include the costs of parts, labor, and transportation.

THIS WARRANTY IS EXCLUSIVE, AND IS IN LIEU OF ANY OTHER WARRANTIES, EXPRESS OR IMPLIED, INCLUDING BUT NOT LIMITED TO WARRANTY OF MERCHANTABILITY OR WARRANTY OF FITNESS FOR A PARTICULAR PURPOSE.

Graco's sole obligation and buyer's sole remedy for any breach of warranty shall be as set forth above. The buyer agrees that no other remedy (including, but not limited to, incidental or consequential damages for lost profits, lost sales, injury to person or property, or any other incidental or consequential loss) shall be available. Any action for breach of warranty must be brought within two (2) years of the date of sale.

GRACO MAKES NO WARRANTY, AND DISCLAIMS ALL IMPLIED WARRANTIES OF MERCHANTABILITY AND FITNESS FOR A PARTICULAR PURPOSE, IN CONNECTION WITH ACCESSORIES, EQUIPMENT, MATERIALS OR COMPONENTS SOLD BUT NOT MANUFACTURED BY GRACO. These items sold, but not manufactured by Graco (such as electric motors, switches, hose, etc.), are subject to the warranty, if any, of their manufacturer. Graco will provide purchaser with reasonable assistance in making any claim for breach of these warranties.

In no event will Graco be liable for indirect, incidental, special or consequential damages resulting from Graco supplying equipment hereunder, or the furnishing, performance, or use of any products or other goods sold hereto, whether due to a breach of contract, breach of warranty, the negligence of Graco, or otherwise.

FOR GRACO CANADA CUSTOMERS

The Parties acknowledge that they have required that the present document, as well as all documents, notices and legal proceedings entered into, given or instituted pursuant hereto or relating directly or indirectly hereto, be drawn up in English. Les parties reconnaissent avoir convenu que la rédaction du présente document sera en Anglais, ainsi que tous documents, avis et procédures judiciaires exécutés, donnés ou intentés, à la suite de ou en rapport, directement ou indirectement, avec les procédures concernées.

Graco Information

For the latest information about Graco products, visit www.graco.com.

To place an order, contact your Graco Distributor or call to identify the nearest distributor.

Phone: 612-623-6921 **or Toll Free:** 1-800-328-0211 **Fax:** 612-378-3505

All written and visual data contained in this document reflects the latest product information available at the time of publication.

Graco reserves the right to make changes at any time without notice.

For patent information, see www.graco.com/patents.

Original Instructions. This manual contains English. MM 332562

Graco Headquarters: Minneapolis

International Offices: Belgium, China, Japan, Korea

GRACO INC. AND SUBSIDIARIES • P.O. BOX 1441 • MINNEAPOLIS MN 55440-1441 • USA

Copyright 2014, Graco Inc. All Graco manufacturing locations are registered to ISO 9001.

www.graco.com
Revision F, January 2018