

# 622-1A Meter-Mix Unit and Control Panel

332077D

EN

**For metering, mixing, and dispensing of silicone material.  
For professional use only.**

**Not approved for use in explosive atmospheres or hazardous locations.**



### **Important Safety Instructions**

Read all warnings and instructions in this manual. Save these instructions.

See page 2 for model information, including maximum working pressure and approvals.

If the visuals in the printed copy are unclear, refer to the electronic version available on [www.graco.com](http://www.graco.com).

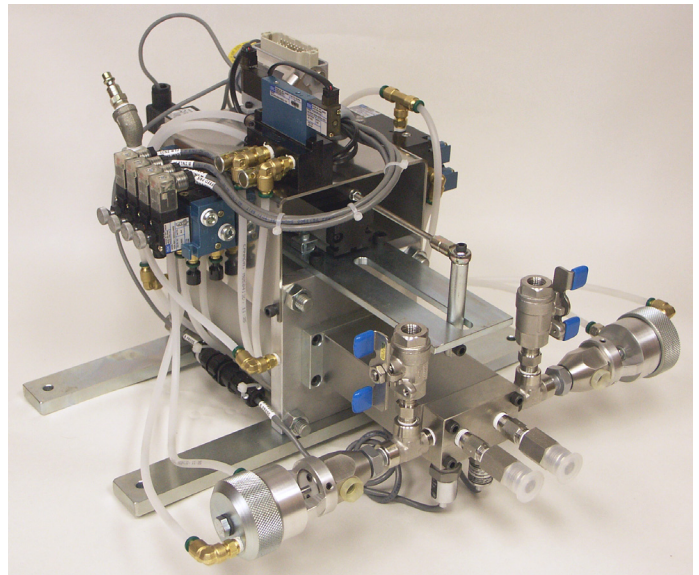

# Contents

<b>Contents</b> .....	<b>2</b>	<b>Shutdown</b> .....	<b>37</b>
<b>Related Manuals</b> .....	<b>2</b>	<b>Pressure Relief Procedure</b> .....	<b>38</b>
<b>Models</b> .....	<b>2</b>	Manual Mode .....	38
<b>Warnings</b> .....	<b>3</b>	<b>Operation</b> .....	<b>39</b>
<b>Component Identification</b> .....	<b>6</b>	<b>Testing Procedures</b> .....	<b>40</b>
Model 622-1A .....	6	Pump Testing .....	40
<b>General Information</b> .....	<b>8</b>	<b>Troubleshooting</b> .....	<b>41</b>
Pressure Settings .....	8	Calibrate Pressure Transducers .....	41
Solvents .....	8	<b>Schematics</b> .....	<b>42</b>
<b>Screen Navigation</b> .....	<b>9</b>	<b>Dimensions</b> .....	<b>45</b>
<b>Screen Identification</b> .....	<b>16</b>	Model 622-1A .....	45
<b>Installation</b> .....	<b>32</b>	<b>Technical Data</b> .....	<b>47</b>
<b>Setup</b> .....	<b>34</b>	<b>Graco Standard Warranty</b> .....	<b>48</b>
<b>Startup</b> .....	<b>36</b>	<b>Graco Information</b> .....	<b>48</b>

## Related Manuals









Manual	Description
332338	622-1A Meter-Mix Unit and Control Panel, Instructions-Parts

## Models

Part No.	Maximum Working Pressures psi (MPa, bar)	Description
622-1A	3000 (21, 207)	PLC, Linear Potentiometer Controlled, Fixed Ratio, Meter Mix Dispense Machine. Machine has proportional pneumatic control to provide automatic adjustment during material dispense. Material supply to the machine can be from 2.5-32 oz (74-946 ml) cartridges or a feed pump.

# Warnings

The following warnings are for the setup, use, grounding, maintenance, and repair of this equipment. The exclamation point symbol alerts you to a general warning and the hazard symbols refer to procedure-specific risks. When these symbols appear in the body of this manual or on warning labels, refer back to these Warnings. Product-specific hazard symbols and warnings not covered in this section may appear throughout the body of this manual where applicable.

 <b>WARNING</b>	
  	<p><b>ELECTRIC SHOCK HAZARD</b></p> <p>This equipment must be grounded. Improper grounding, setup, or usage of the system can cause electric shock.</p> <ul style="list-style-type: none"> <li>• Turn off and disconnect power cord before servicing equipment.</li> <li>• Connect only to grounded electrical outlets.</li> <li>• Use only 3-wire extension cords.</li> <li>• Ensure ground prongs are intact on power and extension cords.</li> <li>• Do not expose to rain. Store indoors</li> </ul>
	<p><b>TOXIC FLUID OR FUMES HAZARD</b></p> <p>Toxic fluids or fumes can cause serious injury or death if splashed in the eyes or on skin, inhaled, or swallowed.</p> <ul style="list-style-type: none"> <li>• Read MSDSs to know the specific hazards of the fluids you are using.</li> <li>• Store hazardous fluid in approved containers, and dispose of it according to applicable guidelines.</li> <li>• Always wear chemically impermeable gloves when spraying, dispensing, or cleaning equipment.</li> </ul>
	<p><b>PERSONAL PROTECTIVE EQUIPMENT</b></p> <p>Wear appropriate protective equipment when in the work area to help prevent serious injury, including eye injury, hearing loss, inhalation of toxic fumes, and burns. This protective equipment includes but is not limited to:</p> <ul style="list-style-type: none"> <li>• Protective eyewear, and hearing protection.</li> <li>• Respirators, protective clothing, and gloves as recommended by the fluid and solvent manufacturer</li> </ul>
  	<p><b>SKIN INJECTION HAZARD</b></p> <p>High-pressure fluid from dispensing device, hose leaks, or ruptured components will pierce skin. This may look like just a cut, but it is a serious injury that can result in amputation. <b>Get immediate surgical treatment.</b></p> <ul style="list-style-type: none"> <li>• Engage trigger lock when not dispensing.</li> <li>• Do not point dispensing device at anyone or at any part of the body.</li> <li>• Do not put your hand over the fluid outlet.</li> <li>• Do not stop or deflect leaks with your hand, body, glove, or rag.</li> <li>• Follow the <b>Pressure Relief Procedure</b> when you stop dispensing and before cleaning, checking, or servicing equipment.</li> <li>• Tighten all fluid connections before operating the equipment.</li> <li>• Check hoses and couplings daily. Replace worn or damaged parts immediately</li> </ul>

**WARNING**

**FIRE AND EXPLOSION HAZARD**

Flammable fumes, such as solvent and paint fumes, in **work area** can ignite or explode. To help prevent fire and explosion:



- Use equipment only in well ventilated area.
- Eliminate all ignition sources; such as pilot lights, cigarettes, portable electric lamps, and plastic drop cloths (potential static arc).
- Keep work area free of debris, including solvent, rags and gasoline.
- Do not plug or unplug power cords, or turn power or light switches on or off when flammable fumes are present.
- Ground all equipment in the work area. See **Grounding** instructions.
- Use only grounded hoses.
- Hold gun firmly to side of grounded pail when triggering into pail. Do not use pail liners unless they are antistatic or conductive.
- **Stop operation immediately** if static sparking occurs or you feel a shock. Do not use equipment until you identify and correct the problem.
- Keep a working fire extinguisher in the work area.

**EQUIPMENT MISUSE HAZARD**

Misuse can cause death or serious injury.

- Do not operate the unit when fatigued or under the influence of drugs or alcohol.
- Do not exceed the maximum working pressure or temperature rating of the lowest rated system component. See **Technical Data** in all equipment manuals.
- Use fluids and solvents that are compatible with equipment wetted parts. See **Technical Data** in all equipment manuals. Read fluid and solvent manufacturer's warnings. For complete information about your material, request MSDS from distributor or retailer.
- Turn off all equipment and follow the **Pressure Relief Procedure** when equipment is not in use.
- Check equipment daily. Repair or replace worn or damaged parts immediately with genuine manufacturer's replacement parts only.
- Do not alter or modify equipment. Alterations or modifications may void agency approvals and create safety hazards.
- Make sure all equipment is rated and approved for the environment in which you are using it.
- Use equipment only for its intended purpose. Call your distributor for information.
- Route hoses and cables away from traffic areas, sharp edges, moving parts, and hot surfaces.
- Do not kink or over bend hoses or use hoses to pull equipment.
- Keep children and animals away from work area.
- Comply with all applicable safety regulations.

 **WARNING**

 	<p><b>MOVING PARTS HAZARD</b></p> <p>Moving parts can pinch, cut or amputate fingers and other body parts.</p> <ul style="list-style-type: none"><li>• Keep clear of moving parts.</li><li>• Do not operate equipment with protective guards or covers removed.</li><li>• Pressurized equipment can start without warning. Before checking, moving, or servicing equipment, follow the <b>Pressure Relief Procedure</b> and disconnect all power sources.</li></ul>
	<p><b>SPLATTER HAZARD</b></p> <p>Hot or toxic fluid can cause serious injury if splashed in the eyes or on skin. During blow off of platen, splatter may occur.</p> <ul style="list-style-type: none"><li>• Use minimum air pressure when removing platen from drum.</li></ul>

# Component Identification

## Model 622-1A

- |   |  |    |                                     |
|---|--|----|-------------------------------------|
| A | Intensifier Override Button              | S  | Colorant Injector Valve             |
| B | "A" Inlet Valve Override Button          | T  | Double Pass Mixer with Water Jacket |
| C | "B" Inlet Valve Override Button          | U  | Optional Material Filter            |
| D | Color Injector Override Button           | V  | Optional Outlet Valve               |
| E | Intensifier Pressure Regulator and Gauge | W  | Emergency Stop                      |
| F | Intensifier Ram Retract Button           | X  | Power On                            |
| G | Cartridge Retaining Ring                 | Y  | Operator Interface Panel            |
| J | Bleed Valve                              | Z  | Air Motor Solenoid                  |
| K | Colorant Cartridge Regulator and Gauge   | AA | Linear Sensor Plug                  |
| L | Colorant Cartridge Pressure Cap          | AB | Refill Valve                        |
| M | Colorant Cartridge Retainer              | AC | Main Air Connection                 |
| N | Material Hose Connection                 | AD | Ratio Sample Valve                  |
| P | Material Pressure Gauge                  |    |                                     |
| R | Colorant Injector Bleed Valve            |    |                                     |

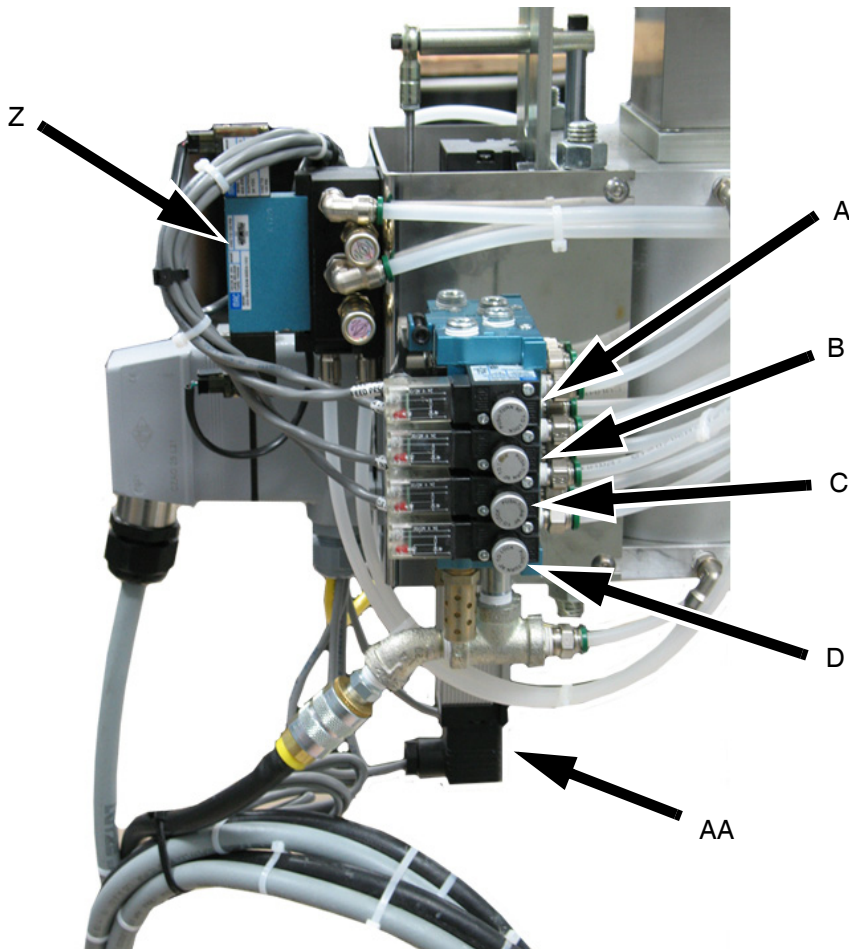

FIG. 1: 622-1A

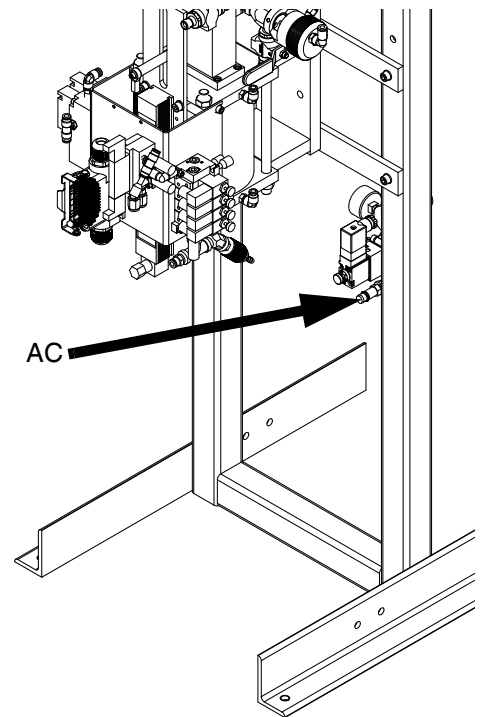
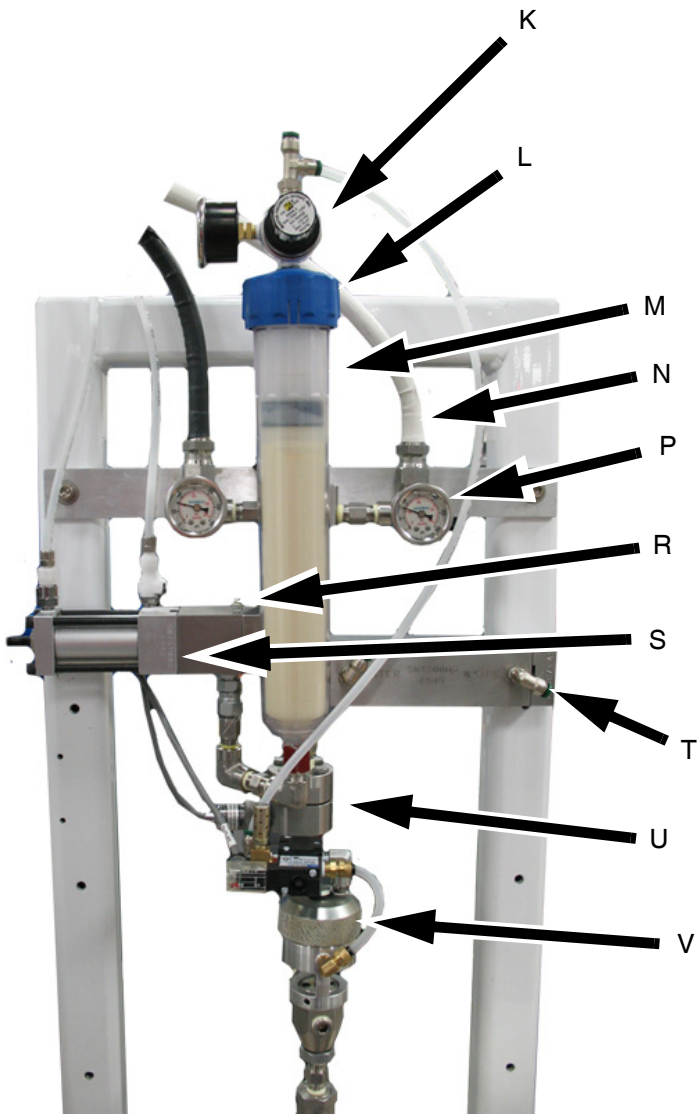
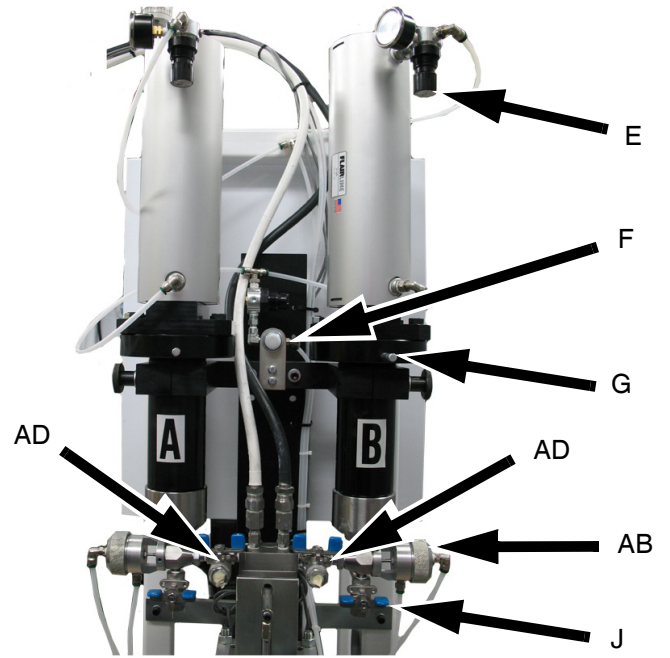
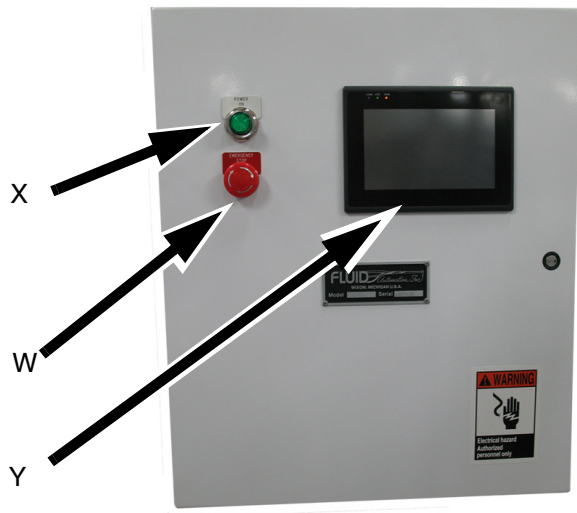

FIG. 2: 622-1A

# General Information

## Pressure Settings

All pressure settings are controlled through the Operator Interface Panel. Refer to **Screen 2**, page 24, to set the feed station pressure.

### NOTICE

To avoid machine damage, do not exceed 120 psi (0.8 MPa, 8.3 bar) air pressure at the machine inlet.

## Fluid Pressure Gauges

All A and B material pressure gauges should read the same as each other during normal operation of the machine.

## Solvents

These are rarely used with modern 1:1 silicones. For cleaning, methylene chloride or white spirits solvent are used. Methylene chloride is recommended because it is non-flammable.



To avoid serious injury, do not use flammable solvents for cleaning.



# Screen Navigation

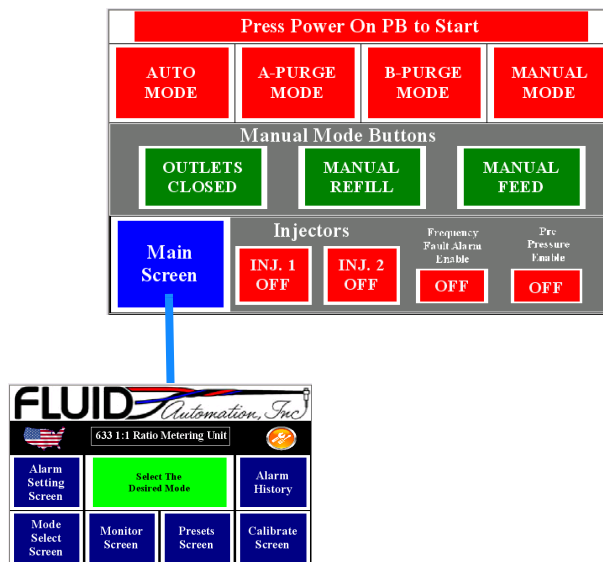
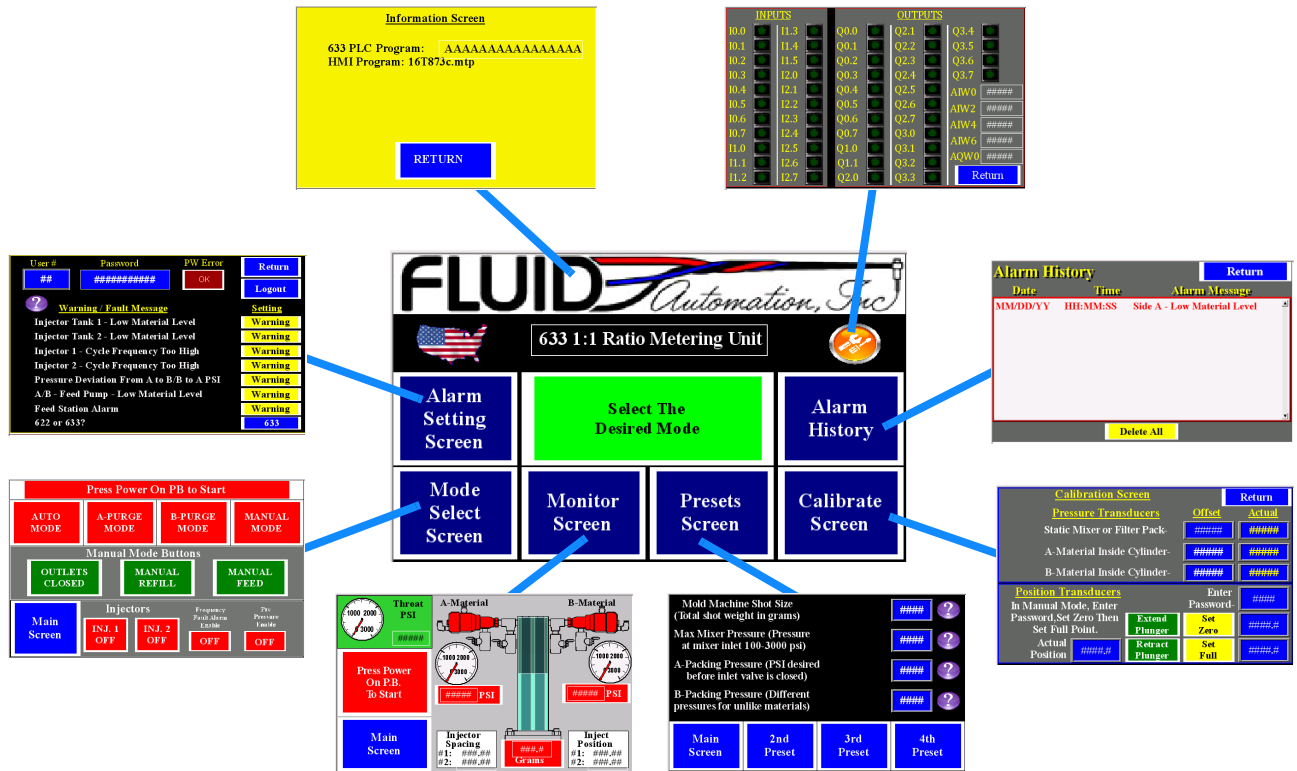

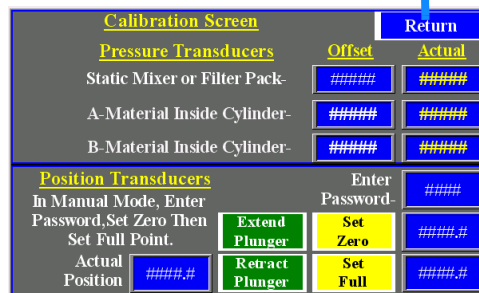
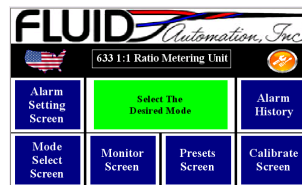
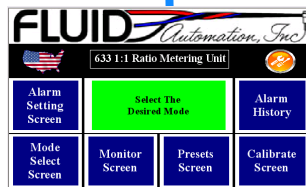
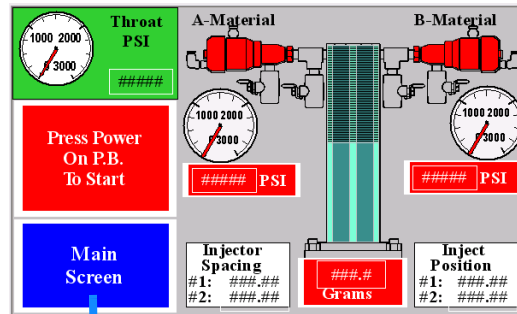

Refer to **Screen 1**, page 22, for more details.

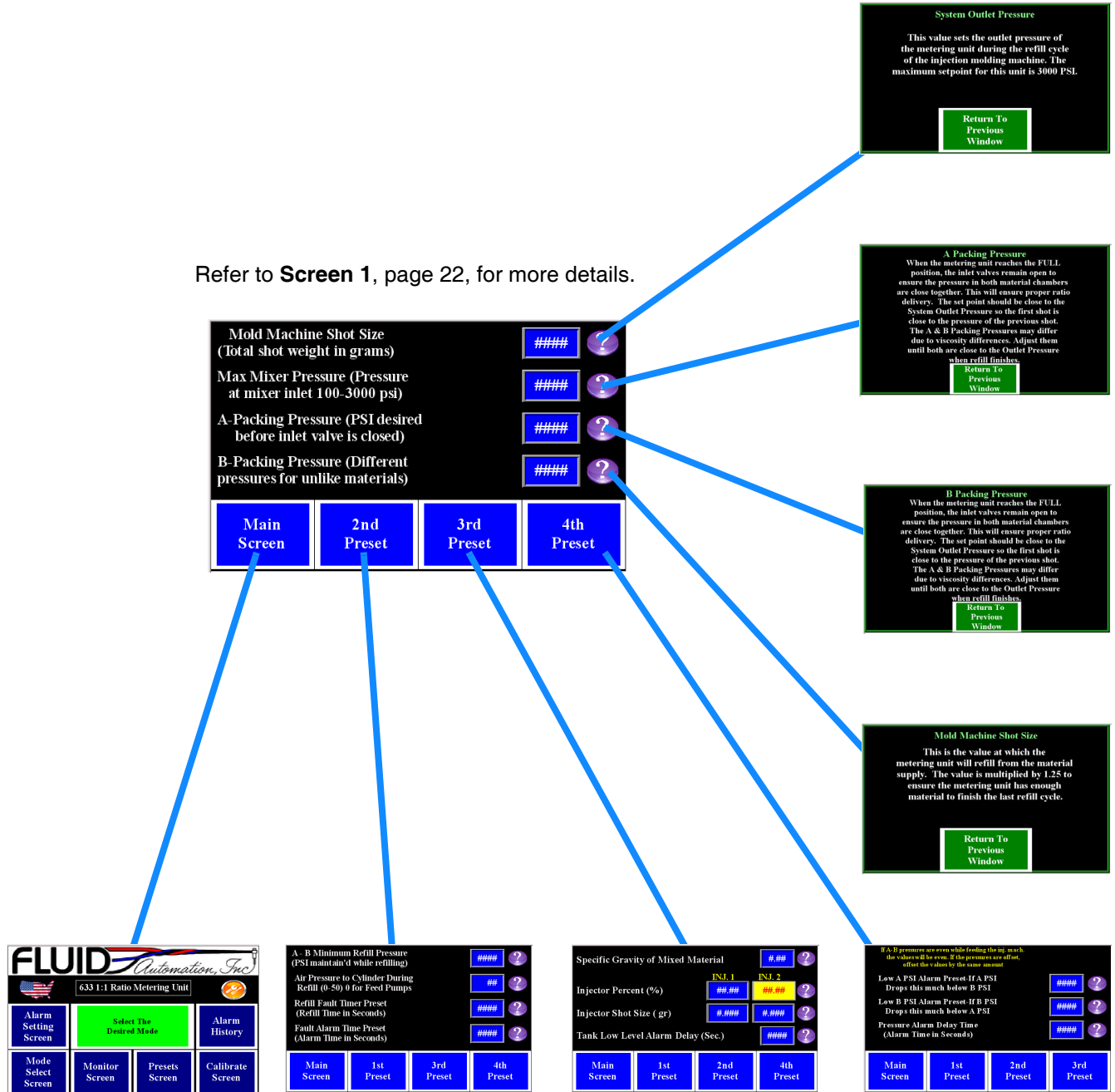

Refer to **Screen 2**, page 23, for more details.

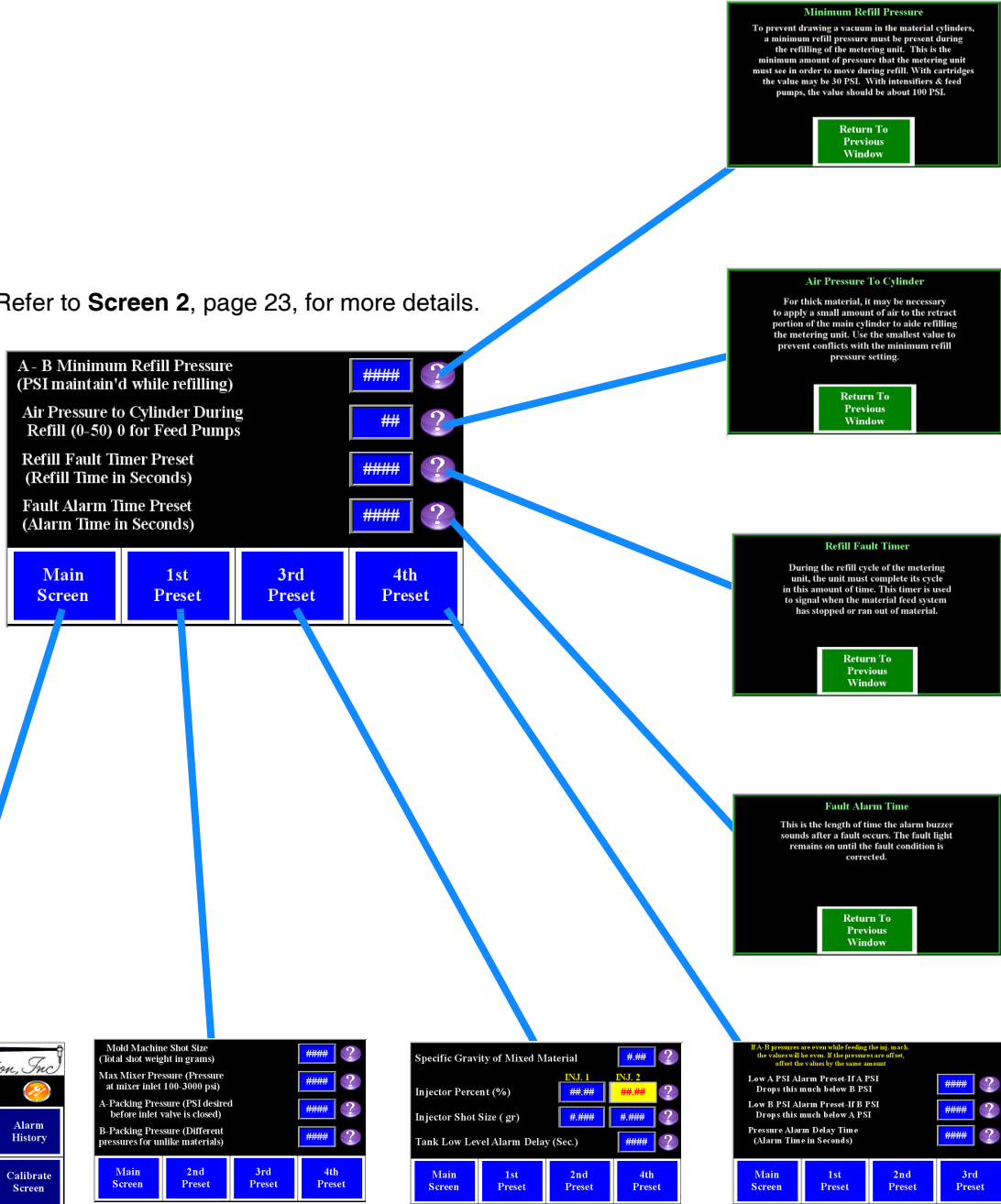

Refer to **Screen 3**, page 23, for more details.

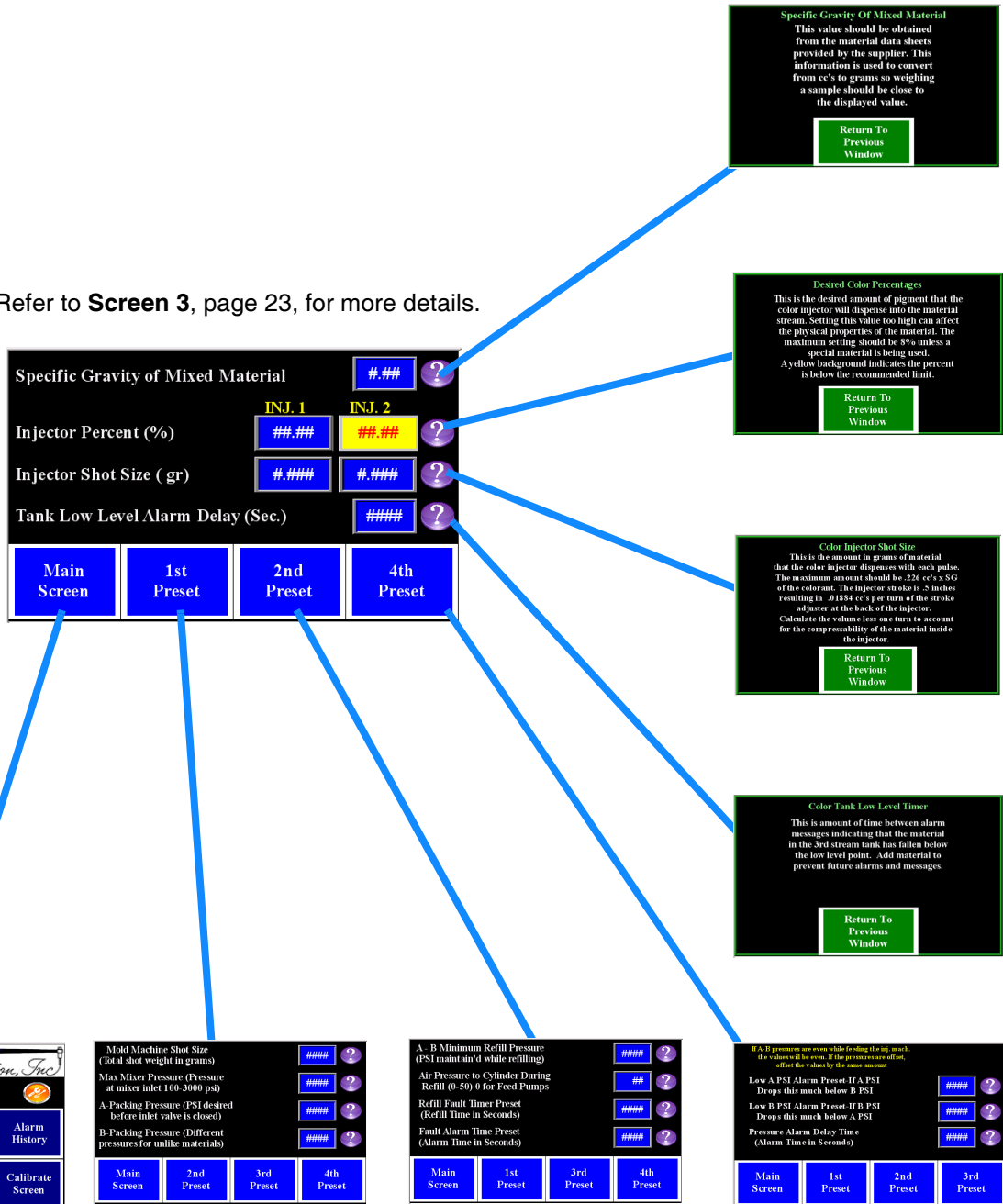

Refer to **Screen 4**, page 24, for more details.

If A-B pressures are even while feeding the inj. mach. the values will be even. If the pressures are off set, offset the values by the same amount

Low A PSI Alarm Preset-If A PSI Drops this much below B PSI  ?

Low B PSI Alarm Preset-If B PSI Drops this much below A PSI  ?

Pressure Alarm Delay Time (Alarm Time in Seconds)  ?

Main Screen 1st Preset 2nd Preset 3rd Preset

Low A-Pressure Alarm Preset

At the end of the refill cycle, the system compares the PSI in A to the B cylinder to ensure it has refilled correctly. If the pressure deviates outside this limit, a fault will occur. This can indicate a failure of the outlet check valve which would allow the pressure inside the hose to drop.

Return To Previous Window

Low B-Pressure Alarm Preset

At the end of the refill cycle, the system compares the PSI in B to the A cylinder to ensure it has refilled correctly. If the pressure deviates outside this limit, a fault will occur. This can indicate a failure of the outlet check valve which would allow the pressure inside the hose to drop.

Return To Previous Window

Pressure Alarm Delay Time

This is amount of time between the end of refill and the point at which to check the pressure in both the A and B cylinders. A long delay may cause the system to miss an off-ratio condition since the cylinder may have had time to return to pressure during the next dispense cycle.

Return To Previous Window

**FLUID Automation, Inc.**

633 1:1 Ratio Metering Unit

Alarm Setting Screen **Select The Desired Mode** Alarm History

Mode Select Screen Monitor Screen Presets Screen Calibrate Screen

Mold Machine Shot Size (Total shot weight in grams)  ?

Max Mixer Pressure (Pressure at mixer inlet 100-3000 psi)  ?

A-Packing Pressure (PSI desired before inlet valve is closed)  ?

B-Packing Pressure (Different pressures for unlike materials)  ?

Main Screen 2nd Preset 3rd Preset 4th Preset

A-B Minimum Refill Pressure (PSI maintained while refilling)  ?

Air Pressure to Cylinder During Refill (0-50.9 for Feed Pumps)  ?

Refill Fault Timer Preset (Refill Time in Seconds)  ?

Fault Alarm Time Preset (Alarm Time in Seconds)  ?

Main Screen 1st Preset 3rd Preset 4th Preset

Specific Gravity of Mixed Material  ?

Injector Percent (%) INJ 1  INJ 2  ?

Injector Shot Size (gr)   ?

Tank Low Level Alarm Delay (Sec.)  ?

Main Screen 1st Preset 2nd Preset 4th Preset

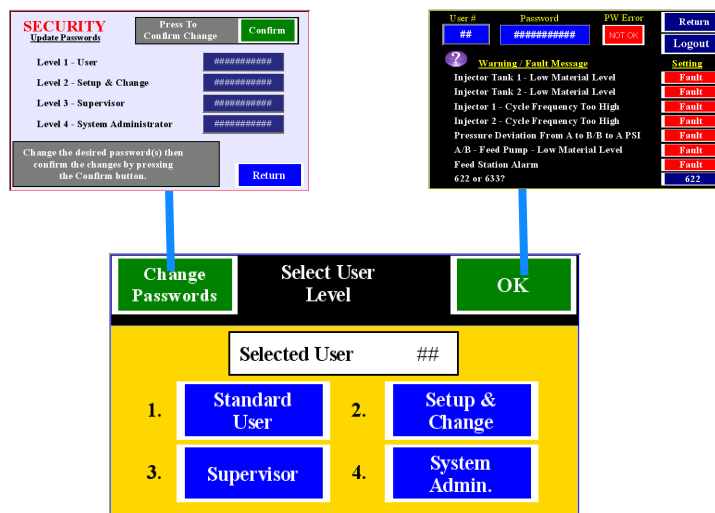
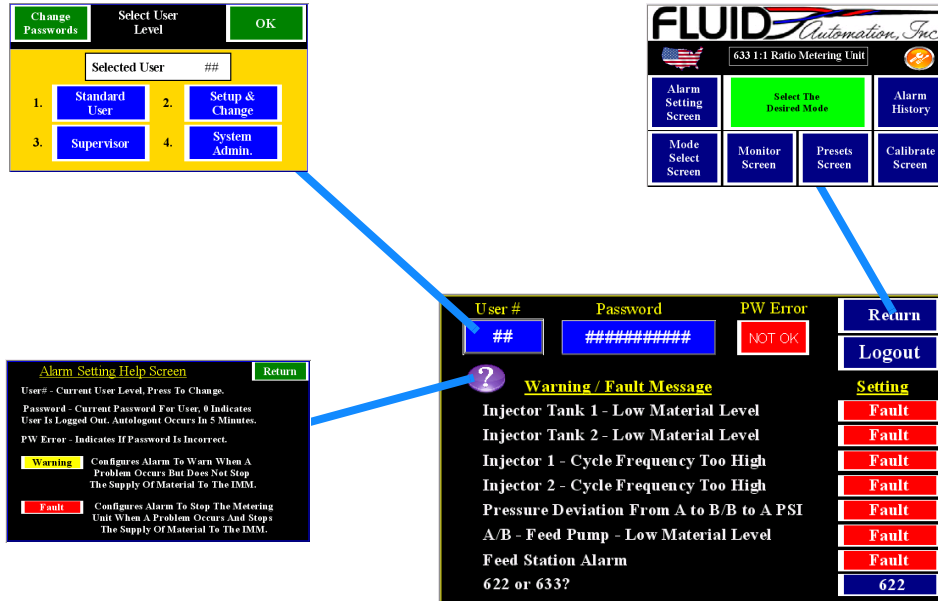



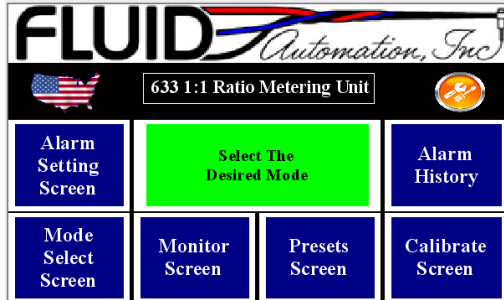

# Screen Identification





## Main Screen



This is the default screen that shows up when the machine is powered on. It shows the current state of the machine and navigates to all screens related to setup and running.

Icon	Description
	Shows the current mode of the machine.
	Navigates to the screen where the user can select the mode to run the machine.
	Navigates to a screen showing: <ul style="list-style-type: none"> <li>• All pressures being monitored on the machine</li> <li>• Grams remaining in the Cylinder</li> <li>• The color injector spacing</li> <li>• The next color injection point</li> </ul>
	Navigates to screens that allow configuration of the machine. <ul style="list-style-type: none"> <li>• Pressure Setpoints</li> <li>• Refill Setpoints</li> <li>• Pressure Thresholds for Alarms</li> <li>• Color Injection Parameters</li> </ul>



Icon	Description
	Navigates to a screen allowing calibration of: <ul style="list-style-type: none"> <li>• Pressure Transducers</li> <li>• Cylinder Linear Position Sensor</li> </ul>
	Navigates to a screen allowing the user to select if a condition is either a Warning (keeps the machine running) or a Fault (stops dispensing).
	Navigates to a screen showing the history of alarms that have occurred.
	Navigates to a screen showing what IO is currently active.
	Navigates to a screen showing the software part number and version installed on the machine.

## Mode Select Screen

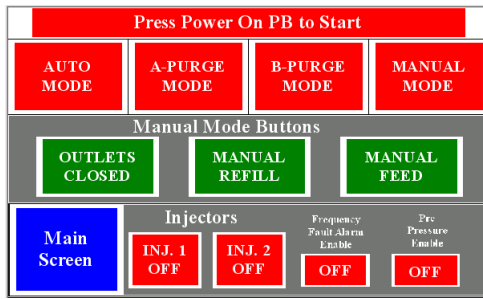

The Mode Select Screen is used for the following:

- Select the mode to operate the machine in.
- Turn color injectors on or off.
- Enable/Disable Frequency Fault Alarms.

Icon	Description
	Allows the machine to operate in a fully automatic mode. It waits for a signal from the press to begin dispensing material. It will dispense as long as the “Screw Rotate Signal” is present and there is material left in the cylinders. Once the cylinder reaches a pre-determined refill point, it will begin refilling. The screw rotate signal must turn off first before the machine will check if it requires refilling.
	This Purges A-Material through the system by reloading only the “A” material. The purge process continues as long as the “Screw Rotate Signal” is active.  <b>NOTE:</b> Before resuming normal operation using a mold, be sure to run enough material through the unit in Auto Mode that it begins to cure.
	This purges B-Material through the system by reloading only the “B” material. The purge process continues as long as the “Screw Rotate Signal” is active.  <b>NOTE:</b> Before resuming normal operation using a mold, be sure to run enough material through the unit in Auto Mode that it begins to cure.
	Allows the operator to fully control the unit through the use of buttons on the operator interface.
	“Outlets Closed” is the default state. It allows the valve to open during a “Manual Feed”. Toggling the button to “Outlets Open” keeps the outlet valve open at all times - even during a refill.
	The unit will refill the pump cylinders while this button is pressed. Letting go of the button mid-refill will cause the machine to stop refilling.
	Begins a Manual Feed cycle. This will continue until either the cylinder reaches the end, or a “Manual Refill” is initiated.
	Turns each injector On or Off.
	Enables or disables frequency faults for the color injectors. It can also occur if the injector is activating faster than it could reload.
	Enables or disables the cartridges to maintain the packing pressure before dispensing.

## Monitor Screen

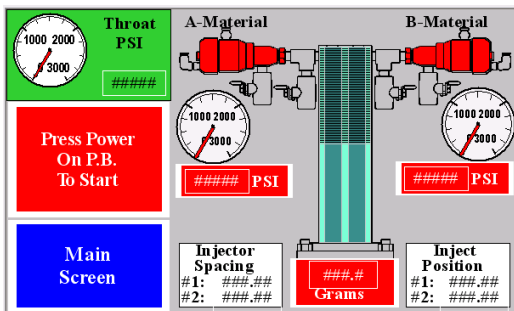

The Monitor Screen shows the vitals of the system at a glance. It indicates how much material remains in the pump and what pressures are in the system. If color injection is enabled, it shows the injection interval and when the next injection will occur.

Icon	Description
	Amount of pressure in the Throat or Mix portion of the unit.
	Shows the current mode of the machine.
	Animation of the refill valve. The default color is red - indicating that it is closed. It turns green when the valve is opened.
	Indicates the pressure in each cylinder of the unit.
	Indicates how much material is remaining in the cylinder
	Indicates how many grams the unit will dispense between color injections.
	Indicates the next time a color injection will be made. It corresponds with the readout indicating how many grams remain in the cylinder.

## Alarm History Screen

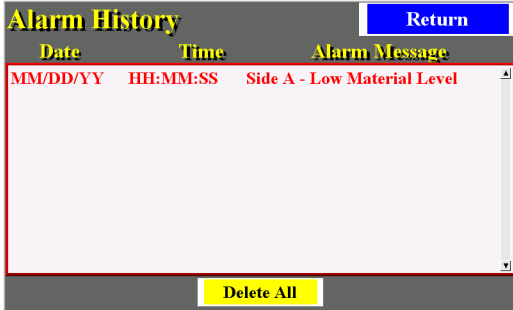

Shows a history of the alarms generated by the unit.

## System IO Screen

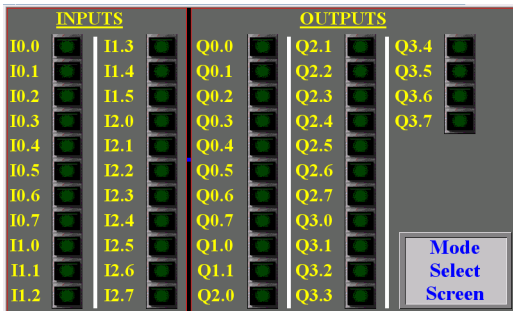

Shows what inputs and outputs are active on the unit.

## Calibration Screen

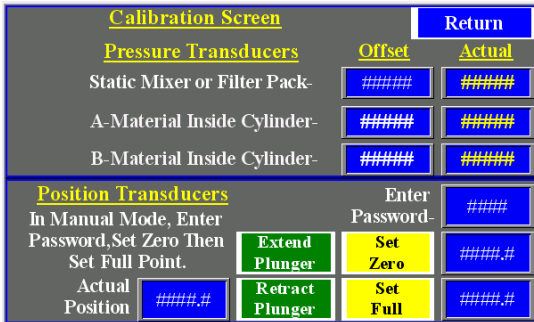





The calibration screen allows the user to adjust any sensor on the system that appears to be out of calibration. The top half of the screen is for pressure transducers and the bottom half is for the position sensor of the pump.

Icon	Description
	Configuring pressure transducers on the unit. The “Actual” is a read only field and the “Offset” is user editable. Refer to <b>Calibrate Pressure Transducers</b> , page 41.
	Indicates the actual position of the pump.
	Calibration of the plunger position is password protected. Enter the password here. After 5 minutes of inactivity, the unit will automatically log out. The default password is 3717.
	Buttons are to be used in “Manual Mode” and are password protected. “Extend Plunger” will open the dispense valve and extend the plunger all the way. Once this is extended, press the “Set Zero” button.
	Buttons are to be used in “Manual Mode” and are password protected. “Retract Plunger” will refill the pump. Once the plunger has stopped moving, press the “Set Full” button.

## Presets Screen

### Screen 1

Mold Machine Shot Size (Total shot weight in grams)	####	?				
Max Mixer Pressure (Pressure at mixer inlet 100-3000 psi)	####	?				
A-Packing Pressure (PSI desired before inlet valve is closed)	####	?				
B-Packing Pressure (Different pressures for unlike materials)	####	?				
<table border="1"> <tr> <td>Main Screen</td> <td>2nd Preset</td> <td>3rd Preset</td> <td>4th Preset</td> </tr> </table>			Main Screen	2nd Preset	3rd Preset	4th Preset
Main Screen	2nd Preset	3rd Preset	4th Preset			

Icon	Description
	<p>The total shot volume of the 622-1A machine is 40 cc's. The value in this field indicates how much material is required to fill the mold in the press. If there is not enough material left in the cylinders to fill the mold, the machine will trigger a refill.</p> <p><b>NOTE:</b> The unit will not perform a refill during mid-dispense if a user enters a value greater than the capacity of the metering unit. If the metering unit runs out of material during a dispense, it will not refill until the "screw rotate signal" turns off.</p>
	<p>The unit monitors the pressure before the material enters the hoses and makes adjustments to maintain this pressure.</p> <p><b>NOTE:</b> There may be a pressure drop at the outlet of the mixer.</p>
 	<p>The unit will leave the inlet valves open until the specified pressure has been reached because the material is compressible. This insures that the unit has been refilled and it has reached the fill point, which is 2 cc's less than the maximum position point. If this pressure is not reached, a refill alarm will sound.</p> <p>The higher viscosity material will require a higher packing pressure. Monitor cylinder pressures during the dispense process and adjust this and the feed station pressures accordingly.</p>

Screen 2

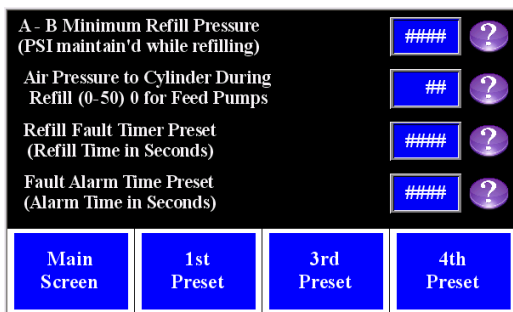

Icon	Description
<b>A - B Minimum Refill Pressure (PSI maintain'd while refilling)</b>	Minimum pressure must be present on both the A and B cylinders during refill. The cylinders will stop refilling until the pressure rises above this set point.
<b>Air Pressure to Cylinder During Refill (0-50) 0 for Feed Pumps</b>	Amount of pressure that is supplied to the pump to assist in refill. It may cause the material to dip below the “A - B Min Refill Pressure” if the pressure is too high. If the metering is being fed with feed pumps, set this value to “0”.
<b>Refill Fault Timer Preset (Refill Time in Seconds)</b>	Amount of time the unit is allotted to refill the cylinders. An alarm will sound and the machine will stop refilling if the unit takes longer to refill.
<b>Fault Alarm Time Preset (Alarm Time in Seconds)</b>	Amount of time the buzzer is on during a fault.

Screen 3

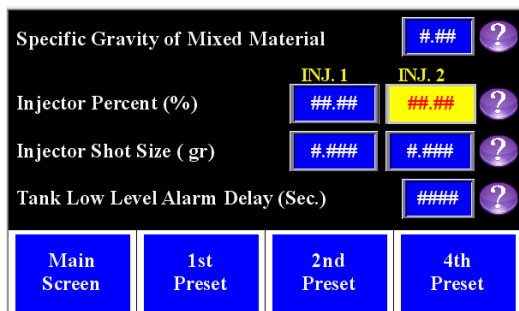

Icon	Description
<b>Specific Gravity of Mixed Material</b>	Specific gravity of the mixed material can be obtained from the material supplier. If the specific gravity of the material is not known, 1.0 is a default value.
<b>Injector Percent (%)</b>	Percent of color to be injected with the amount of material being dispensed. There are separate editable boxes for colors 1 and 2. The field will turn yellow if the entered value is too small.
<b>Injector Shot Size (gr)</b>	Size of the shot being dispensed by each color injector. The shot size is adjustable mechanically and each shot size should be testes individually. Refer to <b>Adjust the Colorant Injector Shot Size</b> , page 34.
<b>Tank Low Level Alarm Delay (Sec.)</b>	Amount of time the unit must detect a low level condition in the colorant tank before it sounds an alarm. (Optional)

Screen 4

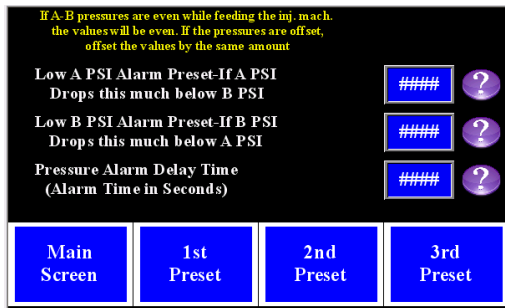





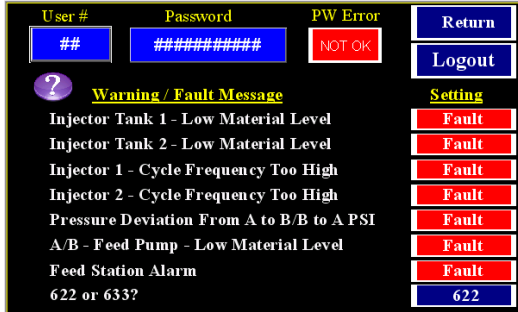

Icon	Description
<p><b>Low A PSI Alarm Preset-If A PSI</b> Drops this much below B PSI</p> <p><b>Low B PSI Alarm Preset-If B PSI</b> Drops this much below A PSI</p>	Both material pressures are being monitored during the refill and dispense cycles of the machine. If the one component material pressure drops below the other component material pressure by X amount, the machine will alert the user.
<p><b>Pressure Alarm Delay Time</b> (Alarm Time in Seconds)</p>	This is the amount of time before the alarm is checked after the refill done bit activates. It allows the data in the analog unit to stabilize prior to checking for a fault.



## Alarm Setting Screen

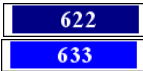

Icon	Description
 	<p>Conditions listed above can be configured as a “Warning” or a “Fault” condition by User #4 (Refer to <b>Select User Level Screen</b>, page 26). Touching the “Warning”/“Fault” text will toggle the condition.</p> <p>A “Warning” will generate a screen describing a condition and sound an alarm - the machine will continue to dispense.</p> <p>A “Fault” will generate the same screen for the condition, but will stop any dispense that is in progress. No further dispenses will be allowed until the condition is corrected.</p>
	<p>Unit can have 4 levels of users that can log into it. Touching this field will navigate to another screen where one can choose the level they want to operate at.</p>
	<p>The login process is completed by entering the password into this field.</p>
	<p>Logs the user out of the system. The user will also be logged out after 5 minutes of inactivity on the operator interface.</p>
	<p>If the correct password is entered, this field will say “OK”. If the wrong password is entered, it will say “NOT OK”.</p>
	<p>Toggles between the 622-1A and 622-1A series machines. Make sure this is displaying the right model number for the machine it is installed on. The machine model number can be located on a tag riveted to the front of the control panel.</p>

## Select User Level Screen

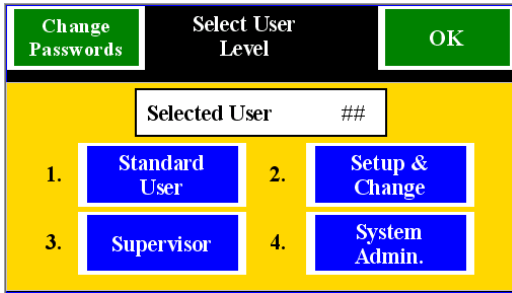

This screen is accessible through the “Alarm Setting Screen”. It selects user levels and allows the “System Admin.” to change passwords.

User Level	Description	Default Password
Level 1 - User	Not Currently Used.	1970
Level 2 - Setup & Change	Not Currently Used.	1971
Level 3 - Supervisor	Not Currently Used.	1972
Level 4 - System Administrator	Changes Passwords & Warning/Fault Levels.	1973

## Security - Update Passwords Screen

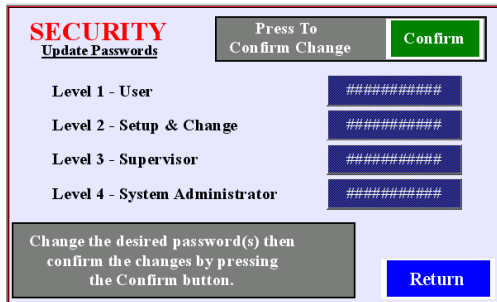

This screen is only accessible by User Level 4 when they are logged in.

Icon	Description
	The current password is displayed here. To change the password, touch the field. When finished, press the “Confirm” button.
	New passwords are not official until the “Confirm” button is pressed. Pressing the return button before “Confirm” will cancel the changes.
Level 1 - User	Not Currently Used.
Level 2 - Setup & Change	Not Currently Used.
Level 3 - Supervisor	Not Currently Used.
Level 4 - System Administrator	Changes Passwords & Warning/Fault Levels.

## Warning and Alarms Screens

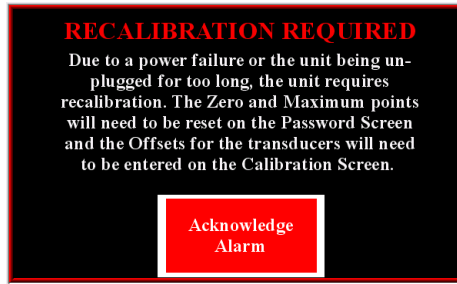

Refer to the Calibration section of the manual for details on calibrating the pressure transducers and the position sensor of the pump.

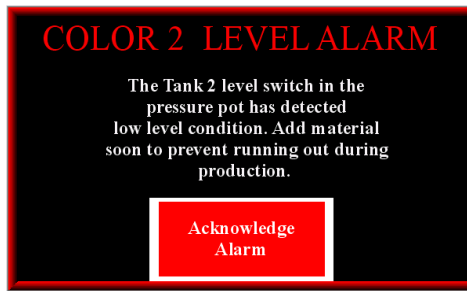
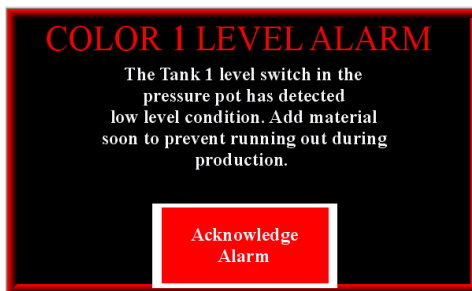

If equipped with a material level sensor on the color reservoir, the warning will indicate that the material level is low. If the warning has never been generated before the machine runs out of colorant, the low level sensor may need to be recalibrated.

This event may be configured as an Alert or a Warning on the Alarm Setting Screen. A warning will allow the machine to keep dispensing; an alert will stop and prevent dispensing until the tank is filled.

**Recalibration:** With the material empty, press the “Empty” switch on the low level sensor. Refer to the low level sensor manual that was provided with the machine to ensure the correct switch is pressed.

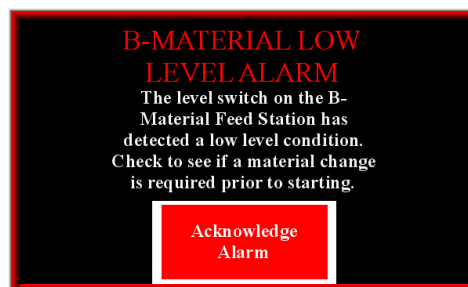
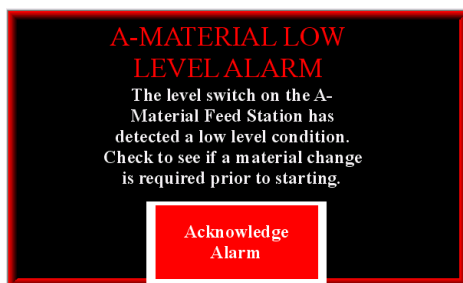

These screens indicate that the machine was not able to refill its plungers properly. The likely cause for this is the feed system was not able to provide material. It is detected by monitoring the pressure in each cylinder during a refill. If installed, refer to the SR657-1M-LR Meter-Mix Dispense Systems-Operation manual for additional details.

This event may be configured as an Alert or a Warning on the Alarm Setting Screen. A warning will allow the machine to keep dispensing; an alert will stop and prevent dispensing until the tank is filled.

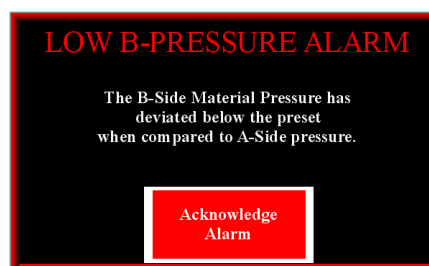
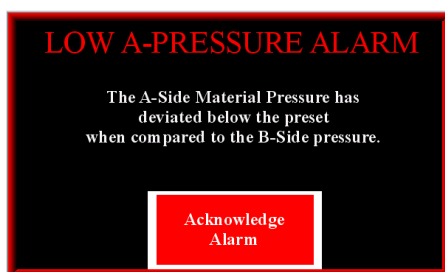

The pressure in the metering unit cylinder is below the expected value. May be caused by the following:

- Be out of material.
- Have an open valve.
- Have a bad plunger seal.
- Have a bad cylinder check valve.

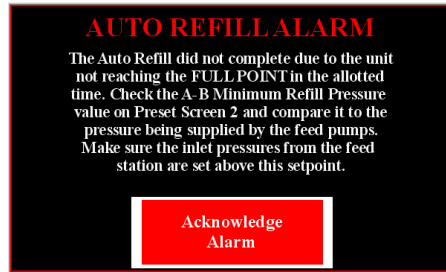

This indicates that the unit could not fill its plungers completely. Verify the following:

- Verify the feed system is functioning and providing enough pressure. If installed, refer to the SR657-1M-LR Meter-Mix Dispense Systems-Operation manual for additional details.
- The A-B Minimum Refill Pressure on Preset Screen 2 is reasonable.
- Air Pressure To Cylinder on Preset Screen 2 may need to be increased.
- The Refill Fault Timer on Preset Screen 2 may need to be increased.

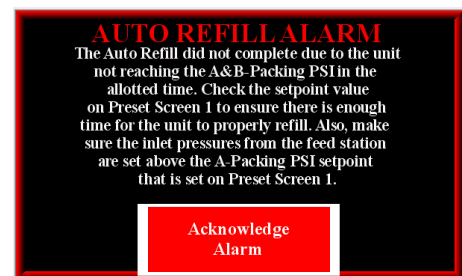
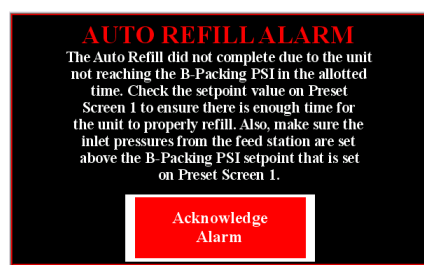

This indicates that the feed unit could not provide enough pressure during refill.

- Verify that it is functioning properly and is providing enough pressure to the unit. If installed, refer to the SR657-1M-LR Meter-Mix Dispense Systems-Operation manual for additional details.
- Verify that a reasonable Packing Pressure has been selected on Preset Screen 1.
- Verify the Refill Fault Timer on Preset Screen 2 provides enough time for refill. Refer to **Calibrate Pressure Transducers**, page 41.

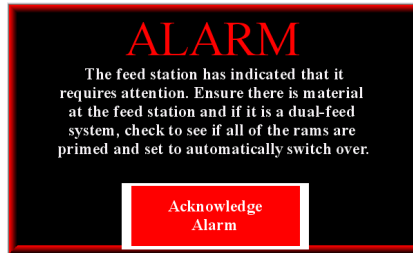

The feed station has indicated that it requires attention. This indicates that it may no longer be able to supply material to the metering unit. Refer to the feed station manual and check if there is sufficient material in it.

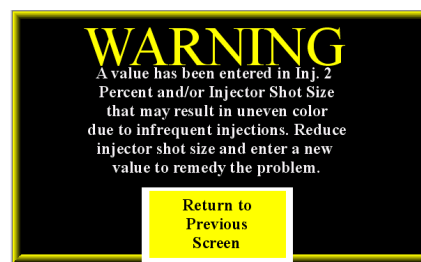
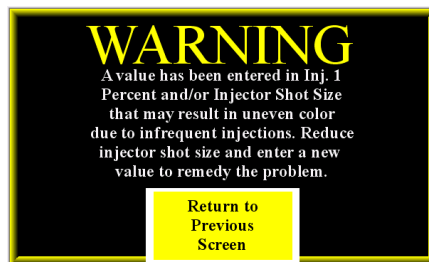

These warnings indicate that the combination of the shot size and the injection percent will result in inconsistent mixture in the material. This can be fixed by decreasing the shot size of the injector. This will cause it to inject material more often.

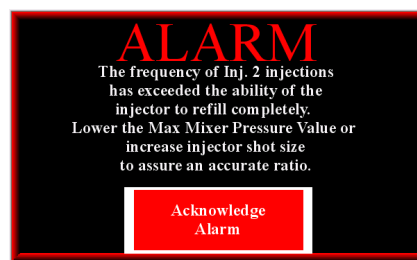
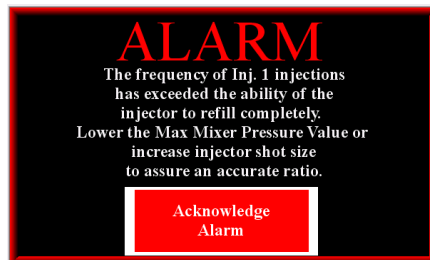

The color injector is designed to dispense the entire contents in about 0.2 seconds. This depends on the air pressure supplied to the color injector. The refill time is approximately the same as the dispense time. It also relies upon the air pressure supplied to the unit. The message will be generated when a shot size is too small. Refer to **Adjust the Colorant Injector Shot Size**, page 34.

# Installation



## 1. Locate and Secure the Machine

- a. Move the machine to a desired location.
- b. Install the feet onto the base.

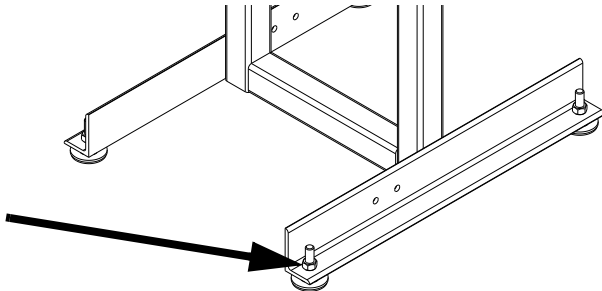

- c. Level the machine by adjusting the height of the feet.

## 2. Connect the Air Source

- a. Connect 100 psi (0.7 MPa, 7 bar) air supply to the air assembly.

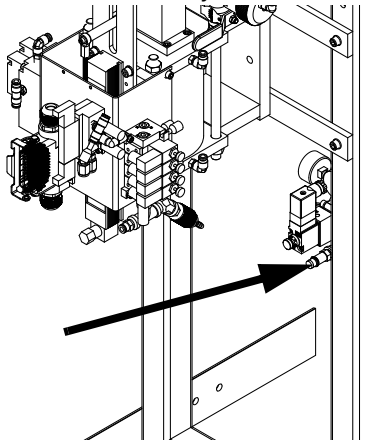

## 3. Ground the System.



The equipment must be grounded to reduce the risk of static sparking. Static sparking can cause fumes to ignite or explode. Grounding provides an escape wire for the electric current.

- a. *622-1A*: grounded through power cord. The machine is shipped with a North American style, 3 prong, 120 VAC plug. For additional electrical power requirements, see **Technical Data**, page 47.
- b. *Dispense Valve*: follow your local code.
- c. *Fluid Supply Containers*: follow your local code.
- d. *Dispensing target/container*: follow your local code.
- e. *To maintain grounding continuity when flushing or relieving pressure*, hold a grounded metal pail firmly to a metal part of the dispense valve, then initiate dispense.

## 4. Connect the Screw Rotate Signal.

- a. Refer to **Schematics**, page 42, for screw rotate signal connections.

**NOTE:** The screw rotate signal tells the machine when to dispense material.



## 5. Fill and Prime the Color Injector (Optional)

- a. Turn "OFF" the main power by pressing the stop button to vent the air from the color feed cartridge.
- b. Unscrew the cap assembly on the color cartridge unit and remove the blank cartridge installed for shipping.
- c. Load the full color cartridge into the housing. If the colorant is thin, install a check valve at the outlet with a 1 pound spring rating to prevent colorant from pouring out the bottom while loading.
- d. Screw the cap assembly back into place.
- e. Reset the stop button.
- f. Press the start button.
- g. Locate the manual override button on the valve stack for the "Color Injector". Press and turn to lock in position. This will move the piston of the Color Injector forward, forcing any air bubbles closer to the bleed port.
- h. Place a 1/4 x 12in. tube over the bleed valve to allow a visual of the purging process.
- i. Open the bleed valve and purge any air from the injector. Positioning the color injector bleed valve upwards or sideways will aid in removing the trapped air.
- j. Close the bleed valve and release the manual over-ride on the Color Injector.

## 6. Load the A and B Materials

- a. Press the Intensifier ram retract button until both ram pistons have fully retracted from the feed cartridges.
- b. Rotate the retaining ring assembly on each cartridge unit
- c. Raise the Intensifier ram and remove the empty cartridges installed for shipping.
- d. Load the full material cartridges into the corresponding A and B sides.

### NOTICE

Pay close attention to prevent loading the material onto the wrong side. Failure to do this may cause the feed passageways to cure.

- e. Align the Intensifier ram with the cartridge.
- f. Lower the ram until seated and rotate the retaining ring back to the locked position.
- g. Locate the manual override button on the valve stack for the "Cartridge Feed Pressure".
- h. Press and turn to lock it into position.
- i. Set the Intensifier pressure to 50 psi (345 kPa, 3.4 bar).
- j. Slowly open the bleed valve and allow enough material to flow out to ensure that all of the air has been purged from the feed cartridge.
- k. Increase the Intensifier pressure if material doesn't flow from the bleed valves.
- l. Close the bleed valve and repeat this procedure for the other material feed.
- m. Release the manual override button for the "Cartridge Feed Pressure".

# Setup

## 1. Set the Material Specific Gravity

- a. Navigate to the “Calibration Screen” from the “Main Screen”.
- b. Using the specific gravity data from the material manufacturer, enter the data in the column labeled “S.G.”.

## 2. Prime Pumps and Material Line Connections

- a. Perform **Pressure Relief Procedure**, page 38.
- b. Remove the material hoses from the mixing block.
- c. Place a waste container under each hose to collect the material.
- d. Press the Cartridge Feed override and set the Intensifier pressure to 50 psi (345 kPa, 3.4 bar).
- e. Release the Cartridge Feed override.
- f. Navigate to the “Mode Select Screen”.
- g. Select “Manual Mode” and press and hold the “Material Refill” button
- h. Observe if the pump drive cylinder is moving downward while holding the Material Refill button. This indicates that the Intensifier pressure is adequate. If there is no movement of the pump drive, increase the Intensifier pressure.

**NOTE:** Air pressure is only applied to the Intensifiers when the Material Refill button is pressed.

- i. Release the Material Refill button once the drive has stopped moving.
- j. Press the “Material Feed” button to dispense material from the metering pumps through the material hoses.

- k. Repeat steps h through j until material flows from both material hoses.
- l. Reconnect them to the mix block once air free material has been dispensed from both material hoses.
- m. Repeat steps h through j until air free material exits the mixer and a sample cures properly.

**NOTE:** During the manual material feed process the colorant pump is not active.

## 3. Adjust the Colorant Injector Shot Size

To properly deliver the correct percentage of colorant to the “A” and “B” material streams, the color injector must be set correctly. Use these procedures to correctly set the “Color Injector Shot Size” on the “Preset Screen”.

- a. Perform **Pressure Relief Procedure**, page 38.
- b. Disconnect the color injector from the manifold assembly.

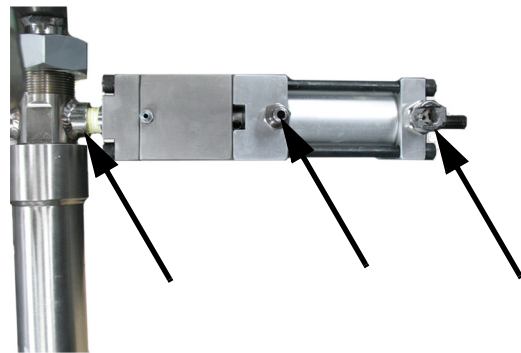

- c. Set the desired stroke length on the injector using the following information:

- Color Injector Maximum Shot Size - 0.226 cc's
- Volume per turn of the adj. Screw - 0.01884 cc's

- Number of turns maximum - 12

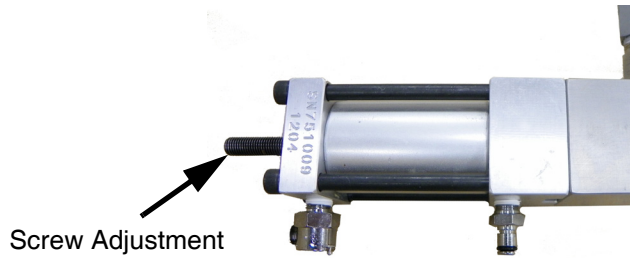

- d. Set the shot as large as possible to prevent air from interfering with the injectors performance.

**NOTE:** No material will flow until about 3/4 to 1 turn of the screw because of the check mechanism inside the injector.

- e. Prime the injector.
- f. Collect a sample of 20 cycles into a tare weighed cup using the manual actuator on the color injector solenoid valve.

- i. Enter the actual value of the shot volume into the “Color Injector Shot Size” variable on the “Preset Screen 3”.
- j. Connect the color injector to the manifold assembly.

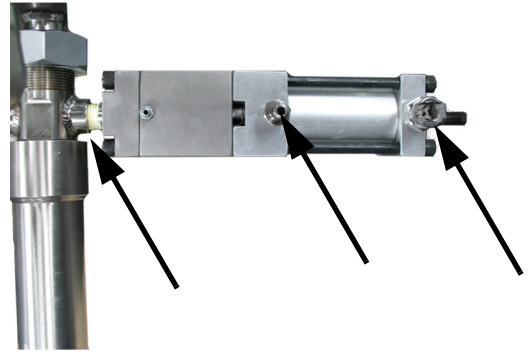

- k. Prime the injector.

<p>To avoid serious injury and machine damage, the color injector control valve should not be set beyond 100 psi (0.7 MPA, 7 bar).</p>						

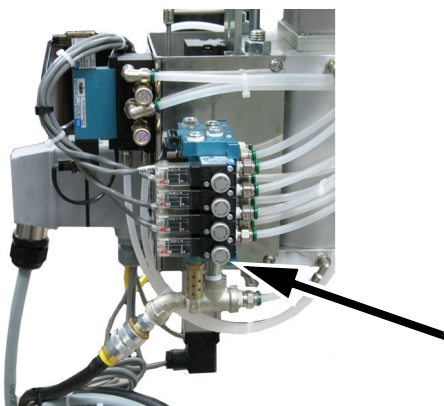

- g. Weigh the cup and subtract the tare weight.
- h. Divide the sample by the number of times the actuator was pressed.

# Startup



Moving parts can pinch or amputate fingers. When the pump is operating and when raising or lowering the pail shelf, keep fingers and hands away from the pump intake, platen, pail shelf, and lip of the pail.

Once the **Setup** procedures have been accomplished, the machine is ready to run. Make certain that all material lines are connected, fittings are tight to prevent leaking, and all manual overrides are in the unlocked position.

To start the machine:

1. Reset the Stop Button if it had been pressed.
2. Press the control power button.
3. Select the desired mode.

**NOTE:** Typical operation is “Auto Mode”.

# Shutdown



## Short Term

Perform the procedure if the machine will be left idle less than the pot life of the material.

1. Perform **Pressure Relief Procedure**, page 38.
2. Press the stop button on the front of the machine.
3. Leave the water cooling circuit running during machine idle times.

### NOTICE

Machine damage may occur from the mixed material if left idle more than the pot life of the material. Refer to **Long Term Shutdown** if machine will be left idle more than the pot life of the material.

## Long Term

Perform the procedure if the machine will be left idle more than the pot life of the material.

1. Perform **Short Term Shutdown** procedure.
2. Remove all assemblies that contain mixed material and clean those components.

# Pressure Relief Procedure



This equipment stays pressurized until pressure is manually relieved. To help prevent serious injury from pressurized fluid, such as skin injection, splashing fluid and moving parts, follow the Pressure Relief Procedure when you stop dispensing and before cleaning, checking, or servicing the equipment.

There are three ways to relieve pressure of the system.

## Manual Mode

Perform the procedure through the Operator Interface Panel.

1. Enter into “Manual” mode from the “Mode Select” screen.
2. Toggle the “Outlets Closed” button so that “Outlets Open” is displayed. This will open the material valves and allow the machine to relieve pressure.
3. Press the Stop button once the pressure has been relieved.
4. Verify the pressure gauge reads 0 psi.

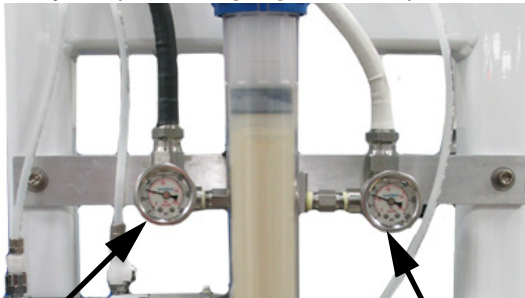

“A” Material Pressure Gauge

“B” Material Pressure Gauge

# Operation

Normal operation of the machine will take place in “Auto Mode.” The metering unit will wait for a “screw rotate signal” from the press or factory automation to start dispensing material.

# Testing Procedures



## Pump Testing

If the machine is suspected of pumping inaccurately, follow these procedures to check each pump.

At normal operating pressure, test if the pump is leaking inside, which will cause one pump side to run at a higher pressure than the other. Follow these steps.

1. Enter into “Auto Mode” and verify the machine performs a refill.
2. Navigate to the “Monitor” screen and observe the material pressures after the fill valves close.

**NOTE:** If the pressure on either side drops by 100 psi (0.7 MPa, 7 bar) or more, the pump may be leaking internally. Refer to **Troubleshooting**, page 41, for possible solutions to pump leakage.



# Troubleshooting



Before performing any troubleshooting procedure:

1. Perform **Pressure Relief Procedure** on page 38.
2. Press the Stop Button.
3. Remove air supply.
4. Allow the press equipment to cool.

## Calibrate Pressure Transducers

Perform this procedure when the “Actual” Value shown on the “Calibration” screen has a difference of 100 psi (7 MPa, 0.7 bar) from the value shown on the analog pressure gauge.

1. Perform **Pressure Relief Procedure** on page 38.
2. Navigate to the “Calibration” screen.
3. Set the offset to “0” on the transducer being calibrated.
4. Type the number displayed in the “Actual” field into the “Offset” field.

# Schematics

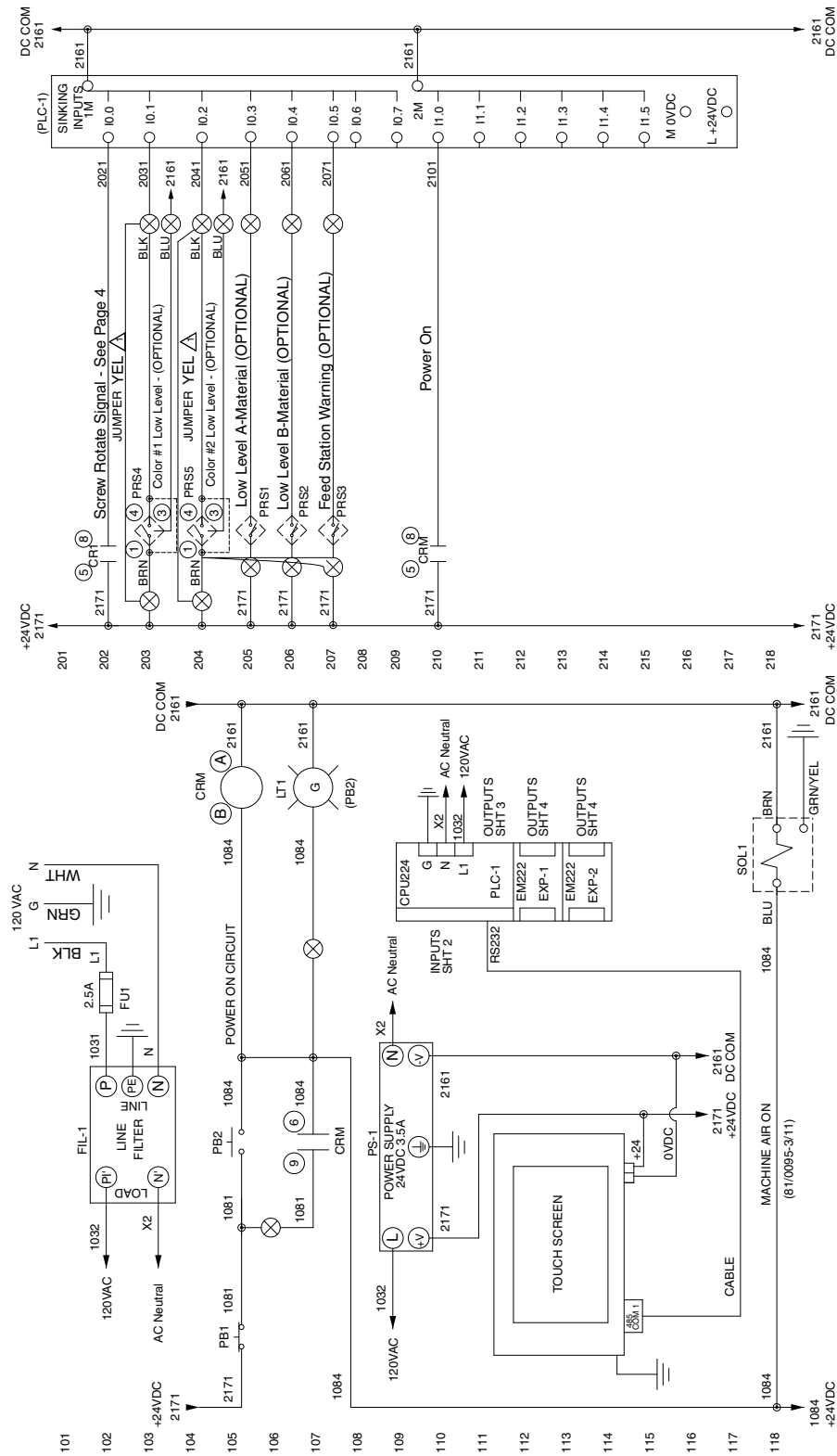

FIG. 3: Electrical - 1

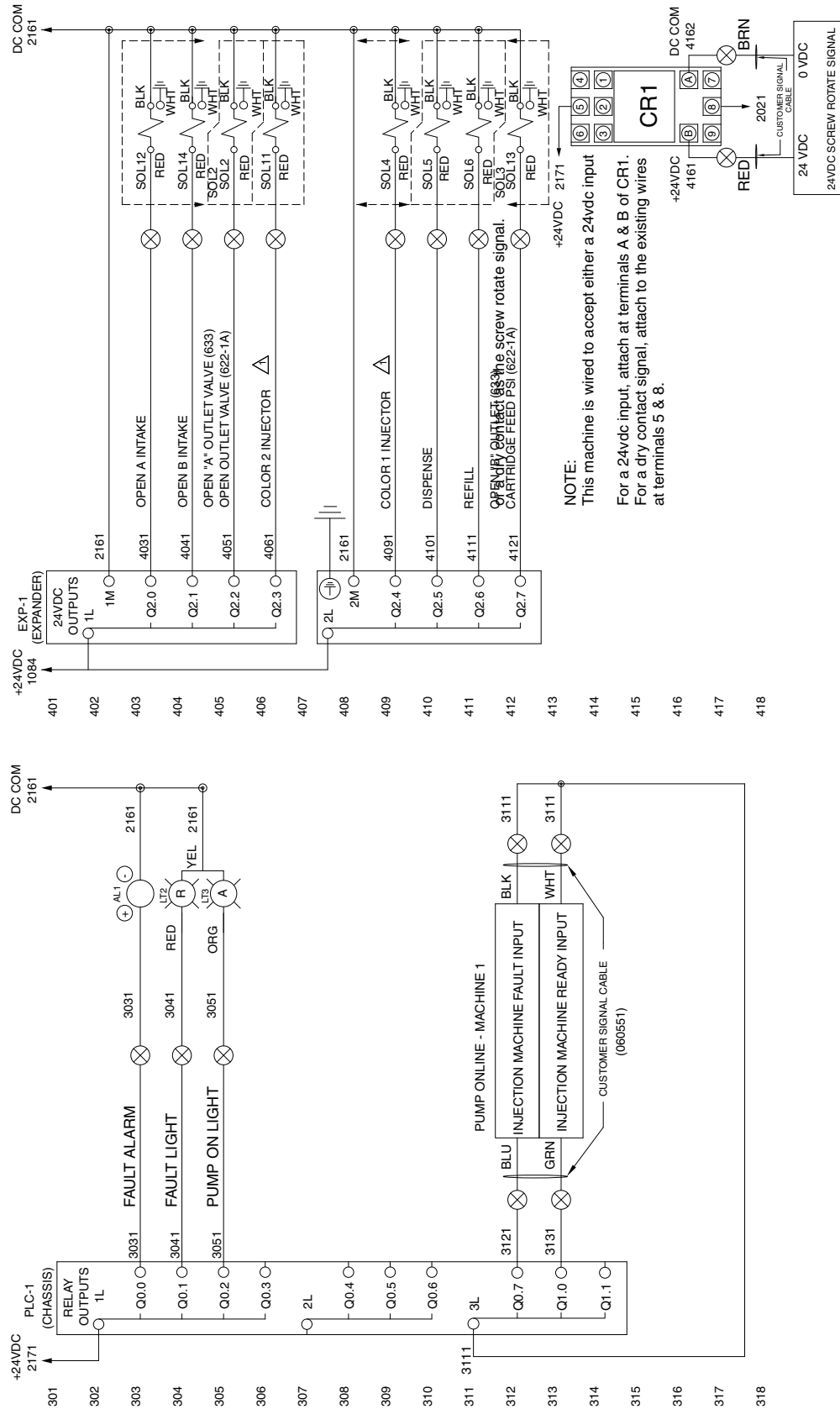

Fig. 4: Electrical - 2

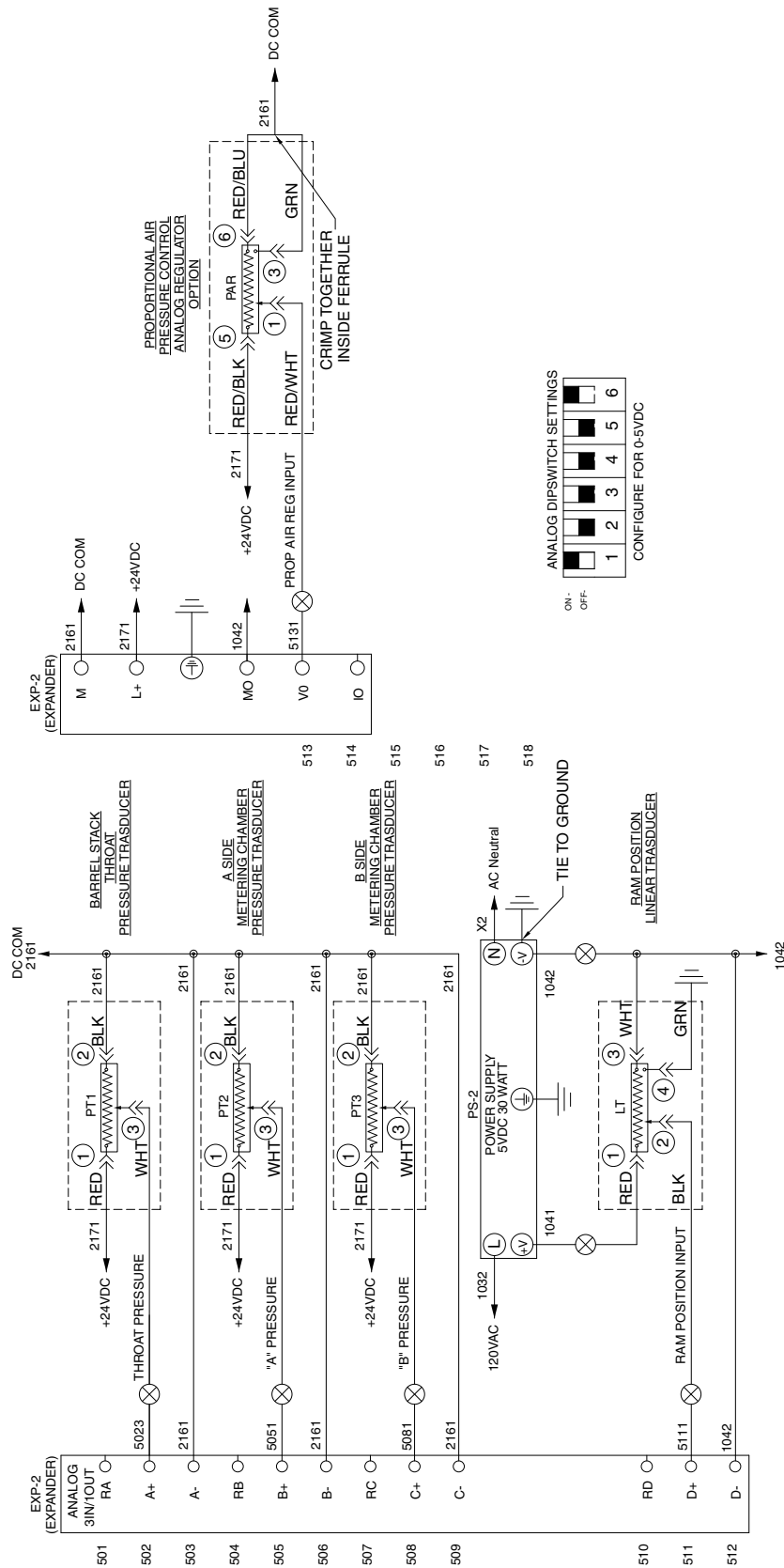
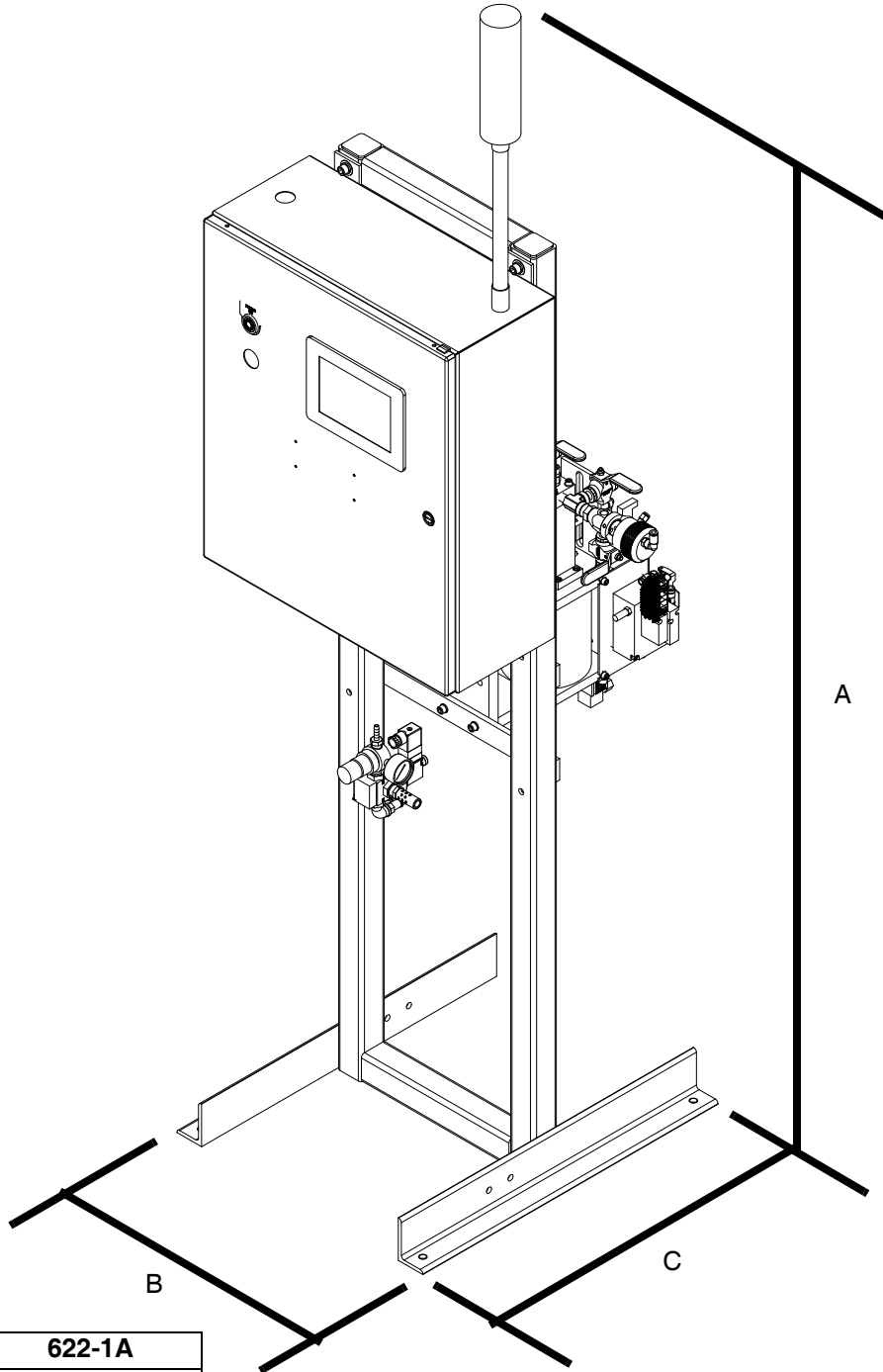

Fig. 5: Electrical - 3

# Dimensions

## Model 622-1A



Dimensions	622-1A
A - Height	72 in. (183 cm)
B - Width	36 in. (91 cm)
C - Depth	48 in. (122 cm)



# Technical Data

<b>622-1A Meter-Mix Dispense Systems</b>		
	<b>US</b>	<b>Metric</b>
Maximum Fluid Working Pressure	3000 psi	21 MPa, 207 bar
Ratio	1:1	
Viscosity Range	50,000 to 3,000,000 centipoise	
Pigment Ratio Range	0.2% to 6%	
Power Requirements	100-120 VAC, 1PH, 50/60 Hz	
AMPS	2.5	
Operating Temperature	Ambient to 120°F	Ambient to 48°C
Maximum Feed Pressure	3000 psi	21 MPa, 207 bar
Maximum Shot Size	1.36 oz (40 cc) total; 0.68 oz (20 cc) per side	
<b>Colorant Tank</b>		
Maximum Air Pressure	100 psi	0.7 MPa, 7 bar
<b>Intensifiers</b>		
Maximum Inlet Air Pressure	100 psi	0.7 MPa, 7 bar
Maximum Outlet Air Pressure	200 psi	1.4 MPa, 14 bar
<b>Air Requirements</b>		
622-1A	32 ft <sup>3</sup> /min @ 100 psi	0.9 m <sup>3</sup> /min @ 0.7 MPa (7 bar)
<b>Materials of Construction</b>		
Wetted materials on all models	303, 304, 316 Stainless Steel, Hard Chrome Carbon Steel, Carbide	
<b>Weight</b>		
622-1A	520 lb	236 kg
<b>Notes</b>		
* Flow rates and viscosities are general estimates. Flow rates drop as viscosity increases. Fluids are expected to shear under pressure. New applications or fluids should always be tested to determine proper line sizes and equipment selections. See your Graco authorized distributor for other capabilities.		

# Graco Standard Warranty

Graco warrants all equipment referenced in this document which is manufactured by Graco and bearing its name to be free from defects in material and workmanship on the date of sale to the original purchaser for use. With the exception of any special, extended, or limited warranty published by Graco, Graco will, for a period of twelve months from the date of sale, repair or replace any part of the equipment determined by Graco to be defective. This warranty applies only when the equipment is installed, operated and maintained in accordance with Graco's written recommendations.

This warranty does not cover, and Graco shall not be liable for general wear and tear, or any malfunction, damage or wear caused by faulty installation, misapplication, abrasion, corrosion, inadequate or improper maintenance, negligence, accident, tampering, or substitution of non-Graco component parts. Nor shall Graco be liable for malfunction, damage or wear caused by the incompatibility of Graco equipment with structures, accessories, equipment or materials not supplied by Graco, or the improper design, manufacture, installation, operation or maintenance of structures, accessories, equipment or materials not supplied by Graco.

This warranty is conditioned upon the prepaid return of the equipment claimed to be defective to an authorized Graco distributor for verification of the claimed defect. If the claimed defect is verified, Graco will repair or replace free of charge any defective parts. The equipment will be returned to the original purchaser transportation prepaid. If inspection of the equipment does not disclose any defect in material or workmanship, repairs will be made at a reasonable charge, which charges may include the costs of parts, labor, and transportation.

**THIS WARRANTY IS EXCLUSIVE, AND IS IN LIEU OF ANY OTHER WARRANTIES, EXPRESS OR IMPLIED, INCLUDING BUT NOT LIMITED TO WARRANTY OF MERCHANTABILITY OR WARRANTY OF FITNESS FOR A PARTICULAR PURPOSE.**

Graco's sole obligation and buyer's sole remedy for any breach of warranty shall be as set forth above. The buyer agrees that no other remedy (including, but not limited to, incidental or consequential damages for lost profits, lost sales, injury to person or property, or any other incidental or consequential loss) shall be available. Any action for breach of warranty must be brought within two (2) years of the date of sale.

**GRACO MAKES NO WARRANTY, AND DISCLAIMS ALL IMPLIED WARRANTIES OF MERCHANTABILITY AND FITNESS FOR A PARTICULAR PURPOSE, IN CONNECTION WITH ACCESSORIES, EQUIPMENT, MATERIALS OR COMPONENTS SOLD BUT NOT MANUFACTURED BY GRACO.** These items sold, but not manufactured by Graco (such as electric motors, switches, hose, etc.), are subject to the warranty, if any, of their manufacturer. Graco will provide purchaser with reasonable assistance in making any claim for breach of these warranties.

In no event will Graco be liable for indirect, incidental, special or consequential damages resulting from Graco supplying equipment hereunder, or the furnishing, performance, or use of any products or other goods sold hereto, whether due to a breach of contract, breach of warranty, the negligence of Graco, or otherwise.

## **FOR GRACO CANADA CUSTOMERS**

The Parties acknowledge that they have required that the present document, as well as all documents, notices and legal proceedings entered into, given or instituted pursuant hereto or relating directly or indirectly hereto, be drawn up in English. Les parties reconnaissent avoir convenu que la rédaction du présente document sera en Anglais, ainsi que tous documents, avis et procédures judiciaires exécutés, donnés ou intentés, à la suite de ou en rapport, directement ou indirectement, avec les procédures concernées.

# Graco Information

## Sealant and Adhesive Dispensing Equipment

For the latest information about Graco products, visit [www.graco.com](http://www.graco.com).

For patent information, see [www.graco.com/patents](http://www.graco.com/patents).

**TO PLACE AN ORDER**, contact your Graco distributor, go to [www.graco.com](http://www.graco.com) and select "Where to Buy" in the top blue bar, or call to find the nearest distributor.

***If calling from the US: 800-746-1334***

***If calling from outside the US: 0-1-330-966-3000***

*All written and visual data contained in this document reflects the latest product information available at the time of publication. Graco reserves the right to make changes at any time without notice.*

Original instructions. This manual contains English. MM 332077

**Graco Headquarters:** Minneapolis

**International Offices:** Belgium, China, Japan, Korea

**GRACO INC. AND SUBSIDIARIES • P.O. BOX 1441 • MINNEAPOLIS MN 55440-1441 • USA**

**Copyright 2013, Graco Inc. All Graco manufacturing locations are registered to ISO 9001.**

[www.graco.com](http://www.graco.com)

Revision D, January 2017