

## LineLazer™ 130HS Airless Line Stripers

3A3392B  
EN

***For the application of line striping materials.  
For professional use only.  
For outdoor use only.  
Not for use in explosive atmospheres or hazardous locations.***

*Maximum Operating Pressure: 3300 psi (22.8 MPa, 228 bar)*



### Important Safety Instructions

Read all warnings and instructions in this manual and in related manuals.  
Be familiar with the controls and the proper usage of the equipment.  
Save these instructions.

LineLazer 130HS		
Model:	Standard 1 Manual Gun	Standard 2 Manual Guns
17H447	✓	
17H448		✓

Related Manuals:	
3A3391	Parts
311254	Gun
311845	Pump

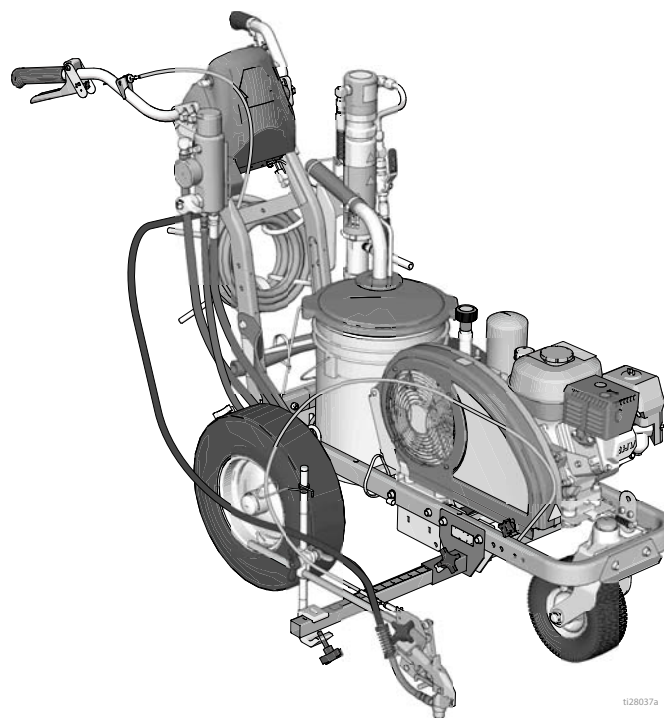

t128037a

*Use only genuine Graco replacement parts.  
The use of non-Graco replacement parts may void warranty.*













# Table of Contents

<b>Warnings</b> .....	<b>3</b>	<b>Cleanup</b> .....	<b>17</b>
<b>Tip Selection</b> .....	<b>6</b>	<b>Maintenance</b> .....	<b>18</b>
<b>Component Identification (LL 130HS)</b> .....	<b>7</b>	LineLazer 130HS .....	18
<b>Grounding Procedure</b>		<b>Troubleshooting</b> .....	<b>19</b>
<b>(For Flammable Flushing Fluids Only)</b> .....	<b>8</b>	<b>Hydraulic Oil/Filter Change</b> .....	<b>21</b>
<b>Pressure Relief Procedure</b> .....	<b>8</b>	Removal .....	21
<b>Setup/Startup</b> .....	<b>9</b>	Installation .....	21
SwitchTip and Guard Assembly .....	11	<b>Technical Data</b> .....	<b>22</b>
<b>Gun Placement</b> .....	<b>12</b>	<b>Notes</b> .....	<b>23</b>
Install Guns .....	12	<b>Graco Standard Warranty</b> .....	<b>24</b>
Position Gun .....	12		
Select Guns .....	12		
Gun Positions Chart .....	13		
Gun Arm Mounts .....	14		
Change Gun Position			
(Front and Back) .....	14		
Change Gun Position			
(Left and Right) .....	15		
Installation .....	15		
Gun Cable Adjustment .....	15		
Straight Line Adjustment .....	16		
Handle Bar Adjustment .....	16		







# Warnings

The following warnings are for the setup, use, grounding, maintenance, and repair of this equipment. The exclamation point symbol alerts you to a general warning and the hazard symbols refer to procedure-specific risks. When these symbols appear in the body of this manual or on warning labels, refer back to these Warnings. Product-specific hazard symbols and warnings not covered in this section may appear throughout the body of this manual where applicable.

 <h1 style="margin: 0;">WARNING</h1>	
   	<p><b>FIRE AND EXPLOSION HAZARD</b></p> <p>Flammable fumes, such as solvent and paint fumes, in <b>work area</b> can ignite or explode. Paint or solvent flowing through the equipment can cause static sparking. To help prevent fire and explosion:</p> <ul style="list-style-type: none"> <li>• Use equipment only in well ventilated area.</li> <li>• Do not fill fuel tank while engine is running or hot; shut off engine and let it cool. Fuel is flammable and can ignite or explode if spilled on hot surface.</li> <li>• Eliminate all ignition sources; such as pilot lights, cigarettes, portable electric lamps, and plastic drop cloths (potential static arc).</li> <li>• Ground all equipment in the work area. See <b>Grounding</b> instructions.</li> <li>• Never spray or flush solvent at high pressure.</li> <li>• Keep work area free of debris, including solvent, rags and gasoline.</li> <li>• Do not plug or unplug power cords, or turn power or light switches on or off when flammable fumes are present.</li> <li>• Use only grounded hoses.</li> <li>• Hold gun firmly to side of grounded pail when triggering into pail. Do not use pail liners unless they are anti-static or conductive.</li> <li>• <b>Stop operation immediately</b> if static sparking occurs or you feel a shock. Do not use equipment until you identify and correct the problem.</li> <li>• Keep a working fire extinguisher in the work area.</li> </ul>
    	<p><b>SKIN INJECTION HAZARD</b></p> <p>High-pressure spray is able to inject toxins into the body and cause serious bodily injury. In the event that injection occurs, <b>get immediate surgical treatment</b>.</p> <ul style="list-style-type: none"> <li>• Do not aim the gun at, or spray any person or animal.</li> <li>• Keep hands and other body parts away from the discharge. For example, do not try to stop leaks with any part of the body.</li> <li>• Always use the nozzle tip guard. Do not spray without nozzle tip guard in place.</li> <li>• Use Graco nozzle tips.</li> <li>• Use caution when cleaning and changing nozzle tips. In the case where the nozzle tip clogs while spraying, follow the <b>Pressure Relief Procedure</b> for turning off the unit and relieving the pressure before removing the nozzle tip to clean.</li> <li>• Equipment maintains pressure after power is shut off. Do not leave the equipment energized or under pressure while unattended. Follow the <b>Pressure Relief Procedure</b> when the equipment is unattended or not in use, and before servicing, cleaning, or removing parts.</li> <li>• Check hoses and parts for signs of damage. Replace any damaged hoses or parts.</li> <li>• This system is capable of producing 3300 psi. Use Graco replacement parts or accessories that are rated a minimum of 3300 psi.</li> <li>• Always engage the trigger lock when not spraying. Verify the trigger lock is functioning properly.</li> <li>• Verify that all connections are secure before operating the unit.</li> <li>• Know how to stop the unit and bleed pressure quickly. Be thoroughly familiar with the controls.</li> </ul>





# WARNING





	<p><b>CARBON MONOXIDE HAZARD</b></p> <p>Exhaust contains poisonous carbon monoxide, which is colorless and odorless. Breathing carbon monoxide can cause death.</p> <ul style="list-style-type: none"> <li>Do not operate in an enclosed area.</li> </ul>
 	<p><b>EQUIPMENT MISUSE HAZARD</b></p> <p>Misuse can cause death or serious injury.</p> <ul style="list-style-type: none"> <li>Do not operate the unit when fatigued or under the influence of drugs or alcohol.</li> <li>Do not exceed the maximum working pressure or temperature rating of the lowest rated system component. See <b>Technical Data</b> in all equipment manuals.</li> <li>Use fluids and solvents that are compatible with equipment wetted parts. See Technical Data in all equipment manuals. Read fluid and solvent manufacturer's warnings. For complete information about your material, request Safety Data Sheet (SDS) from distributor or retailer.</li> <li>Do not leave the work area while equipment is energized or under pressure.</li> <li>Turn off all equipment and follow the <b>Pressure Relief Procedure</b> when equipment is not in use.</li> <li>Check equipment daily. Repair or replace worn or damaged parts immediately with genuine manufacturer's replacement parts only.</li> <li>Do not alter or modify equipment. Alterations or modifications may void agency approvals and create safety hazards.</li> <li>Make sure all equipment is rated and approved for the environment in which you are using it.</li> <li>Use equipment only for its intended purpose. Call your distributor for information.</li> <li>Route hoses and cables away from traffic areas, sharp edges, moving parts, and hot surfaces.</li> <li>Do not kink or over bend hoses or use hoses to pull equipment.</li> <li>Keep children and animals away from work area.</li> <li>Comply with all applicable safety regulations.</li> </ul>
	<p><b>PRESSURIZED ALUMINUM PARTS HAZARD</b></p> <p>Use of fluids that are incompatible with aluminum in pressurized equipment can cause serious chemical reaction and equipment rupture. Failure to follow this warning can result in death, serious injury, or property damage.</p> <ul style="list-style-type: none"> <li>Do not use 1,1,1-trichloroethane, methylene chloride, other halogenated hydrocarbon solvents or fluids containing such solvents.</li> <li>Do not use chlorine bleach.</li> <li>Many other fluids may contain chemicals that can react with aluminum. Contact your material supplier for compatibility.</li> </ul>
 	<p><b>MOVING PARTS HAZARD</b></p> <p>Moving parts can pinch, cut or amputate fingers and other body parts.</p> <ul style="list-style-type: none"> <li>Keep clear of moving parts.</li> <li>Do not operate equipment with protective guards or covers removed.</li> <li>Pressurized equipment can start without warning. Before checking, moving, or servicing equipment, follow the <b>Pressure Relief Procedure</b> and disconnect all power sources.</li> </ul>
	<p><b>ENTANGLEMENT HAZARD</b></p> <p>Rotating parts can cause serious injury</p> <ul style="list-style-type: none"> <li>Keep clear of moving parts.</li> <li>Do not operate equipment with protective guards or covers removed.</li> <li>Do not wear loose clothing, jewelry or long hair while operating equipment.</li> <li>Equipment can start without warning. Before checking, moving, or servicing equipment, follow the <b>Pressure Relief Procedure</b> and disconnect all power sources.</li> </ul>



# WARNING

	<p><b>TOXIC FLUID OR FUMES HAZARD</b></p> <p>Toxic fluids or fumes can cause serious injury or death if splashed in the eyes or on skin, inhaled, or swallowed.</p> <ul style="list-style-type: none"> <li>• Read Safety Data Sheet (SDS) to know the specific hazards of the fluids you are using.</li> <li>• Store hazardous fluid in approved containers, and dispose of it according to applicable guidelines.</li> </ul>
	<p><b>BURN HAZARD</b></p> <p>Equipment surfaces and fluid that's heated can become very hot during operation. To avoid severe burns:</p> <ul style="list-style-type: none"> <li>• Do not touch hot fluid or equipment.</li> </ul>
	<p><b>PERSONAL PROTECTIVE EQUIPMENT</b></p> <p>Wear appropriate protective equipment when in the work area to help prevent serious injury, including eye injury, hearing loss, inhalation of toxic fumes, and burns. This protective equipment includes but is not limited to:</p> <ul style="list-style-type: none"> <li>• Protective eyewear, and hearing protection.</li> <li>• Respirators, protective clothing, and gloves as recommended by the fluid and solvent manufacturer.</li> </ul>
	<p><b>CALIFORNIA PROPOSITION 65</b></p> <p>The engine exhaust from this product contains a chemical known to the State of California to cause cancer, birth defects or other reproductive harm.</p> <p>This product contains a chemical known to the State of California to cause cancer, birth defects or other reproductive harm. Wash hands after handling.</p>

# Tip Selection

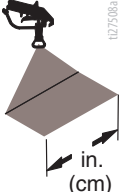
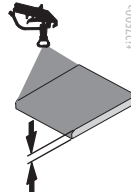
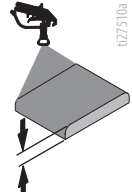
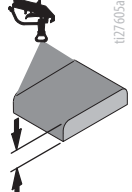
 127506a	 127505a in. (cm)	 127506a in. (cm)	 127507a in. (cm)	 127508a in. (cm)	 127509a	 127510a	 127605a
LL5213*	2 (5)				✓		
LL5215*	2 (5)					✓	
LL5217		4 (10)				✓	
LL5219		4 (10)					✓
LL5315		4 (10)			✓		
LL5317		4 (10)			✓		
LL5319		4 (10)				✓	
LL5321		4 (10)				✓	
LL5323		4 (10)				✓	
LL5325		4 (10)					✓
LL5327		4 (10)					✓
LL5329		4 (10)					✓
LL5331		4 (10)					✓
LL5333		4 (10)					✓
LL5335		4 (10)					✓
LL5355		4 (10)					✓
LL5417			6 (15)		✓		
LL5419			6 (15)		✓		
LL5421			6 (15)		✓		
LL5423			6 (15)			✓	
LL5425			6 (15)			✓	
LL5427			6 (15)			✓	
LL5429			6 (15)			✓	
LL5431			6 (15)				✓
LL5435			6 (15)				✓
LL5621				12 (30)	✓		
LL5623				12 (30)	✓		
LL5625				12 (30)	✓		
LL5627				12 (30)	✓		
LL5629				12 (30)	✓		
LL5631				12 (30)		✓	
LL5635				12 (30)		✓	
LL5639				12 (30)			✓

\*Use 100 mesh filter to reduce tip clogs.

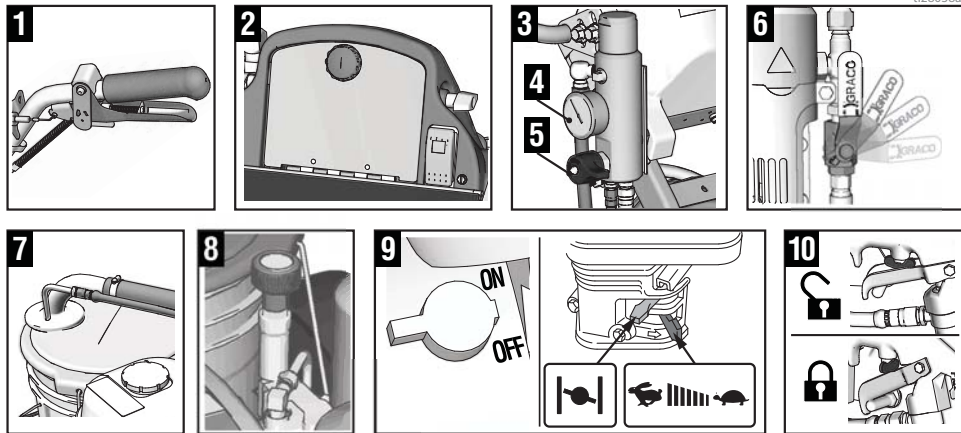
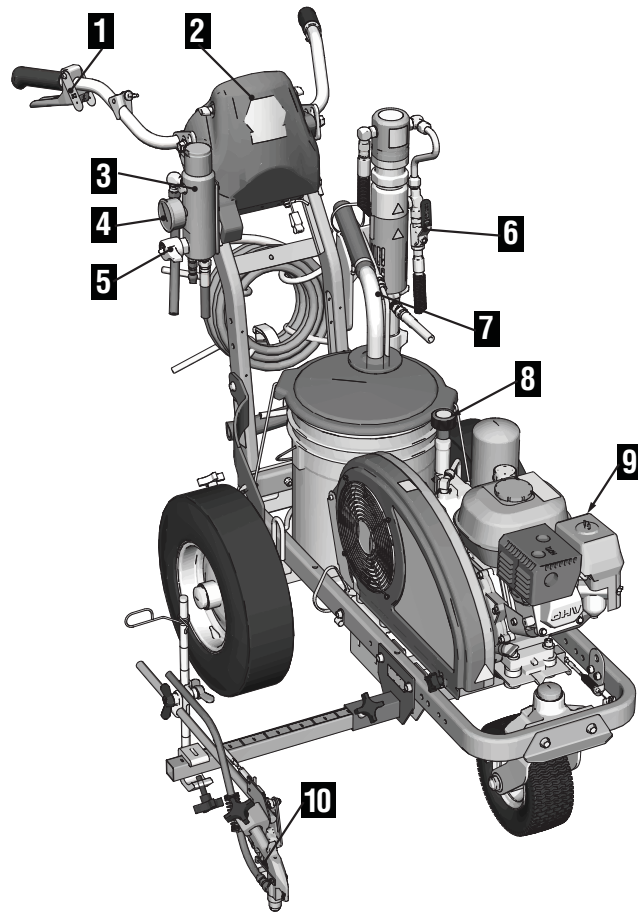

# Component Identification (LL 130HS)



1	Manual spray gun trigger
2	Storage box
3	Filter
4	Pressure gauge
5	Prime/Pressure relief valve

6	Pump ON/OFF lever
7	Drain and siphon tubes
8	Pressure control
9	Engine ON/OFF switch
10	Trigger safety

# Grounding Procedure (For Flammable Flushing Fluids Only)





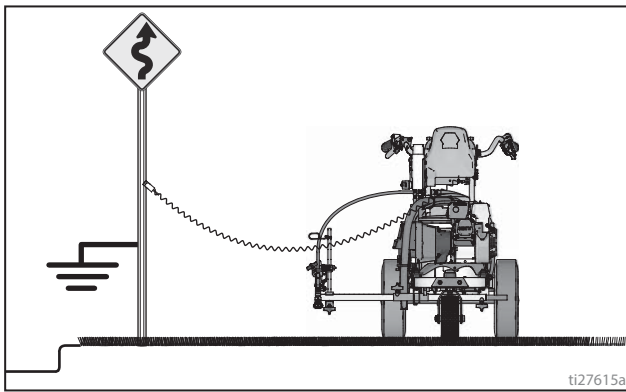

				
<p>This equipment must be grounded to reduce the risk of static sparking. Static sparking can cause fumes to ignite or explode. Grounding provides an escape wire for the electric current.</p>				

1. Position striper so that the tires are not on pavement.
2. Striper is shipped with a grounding clamp. Grounding clamp must attach to grounded object (e.g. metal sign post).



3. Disconnect grounding clamp after flushing is complete.

## Pressure Relief Procedure

				
				
<p>This equipment stays pressurized until pressure is manually relieved. To help prevent serious injury from pressurized fluid, such as skin injection, splashing fluid and moving parts, follow the Pressure Relief Procedure when you stop dispensing and before cleaning, checking, or servicing the equipment.</p>				

1. Perform **Grounding Procedure** if using flammable materials.
2. Set pump switch to **OFF**. Turn engine **OFF**.

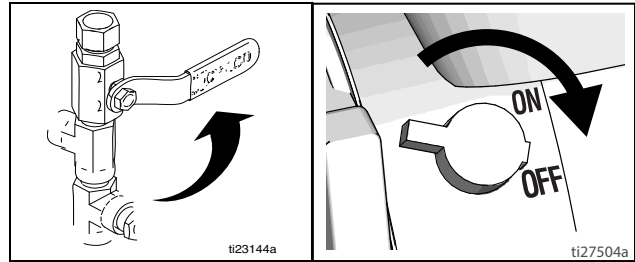

3. Turn pressure control to lowest setting. Trigger all guns to relieve pressure.

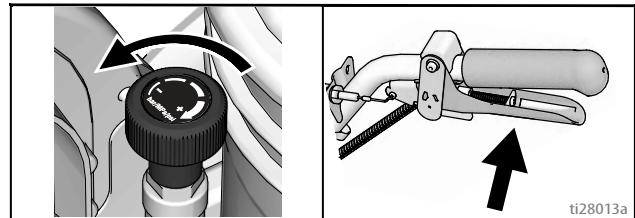

4. Engage all gun trigger locks. Turn prime valve down.

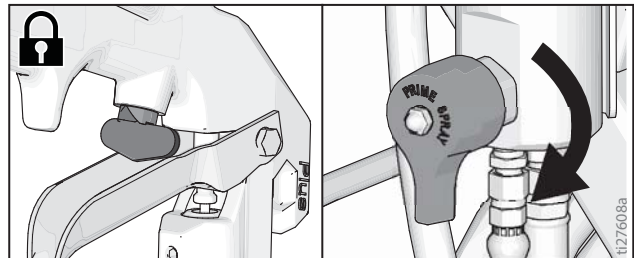

5. If you suspect the spray tip or hose is clogged or that pressure has not been fully relieved:
  - a. **VERY SLOWLY** loosen the tip guard retaining nut or the hose end coupling to relieve pressure gradually.
  - b. Loosen the nut or coupling completely.
  - c. Clear the obstruction in the hose or tip.



# Setup/Startup



This equipment stays pressurized until pressure is manually relieved. To help prevent serious injury from pressurized fluid, such as skin injection, splashing fluid and moving parts, follow the Pressure Relief Procedure when you stop spraying and before cleaning, checking, or servicing the equipment.

1. Perform **Pressure Relief Procedure**, page 8.
2. Perform **Grounding Procedure (For Flammable Flushing Fluids Only)**, page 8 if using flammable materials.
3. Fill throat packing nut with Throat Seal Liquid (TSL) to decrease packing wear.

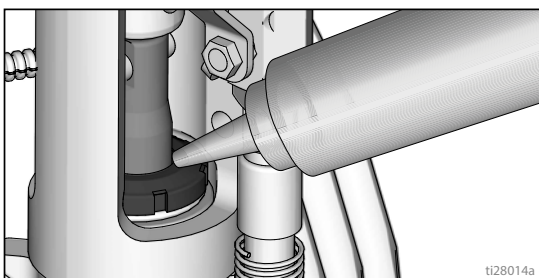

4. Check engine oil level. Add SAE 10W-30 (summer) or 5W-30 (winter). See engine manual.

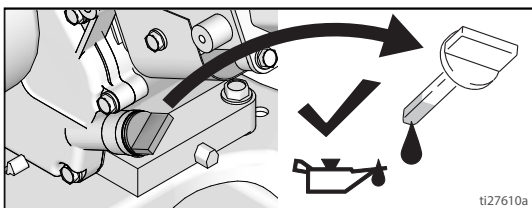

5. Fill fuel tank.

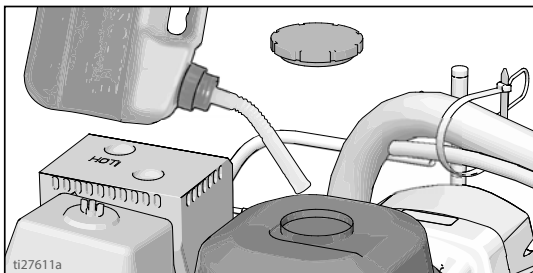

6. Set pump switch to **OFF**.

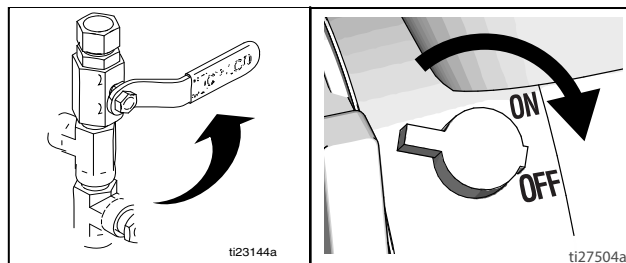

7. If removed, install strainer.

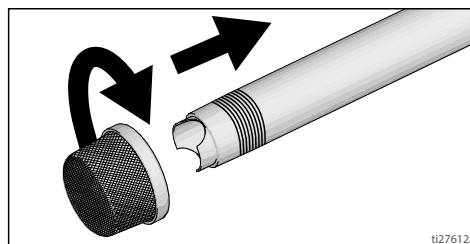

8. Turn prime valve down. Turn pressure control counterclockwise to lowest pressure.



**NOTE:** Minimum hose size allowable for proper sprayer operation is 3/8 in. x 22 ft for LL130HS.

9. Place siphon tube set in grounded metal pail partially filled with flushing fluid. Attach ground wire to true earth ground. Use water to flush water-base paint and mineral spirits to flush oil-base paint and storage oil.

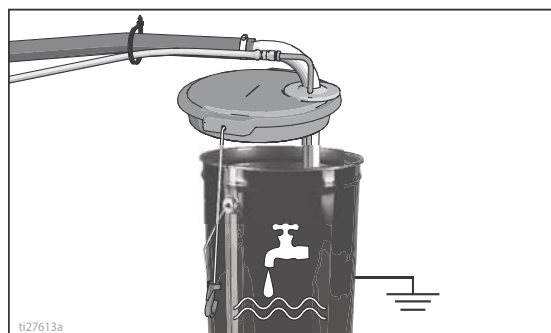

10. Start engine:

a. Move fuel valve to open.

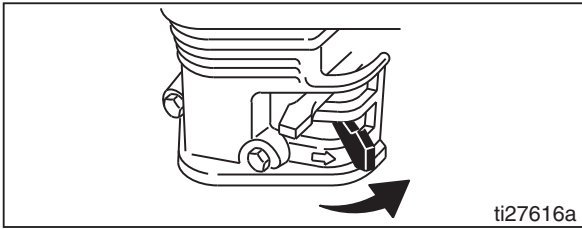

b. Move choke to closed.

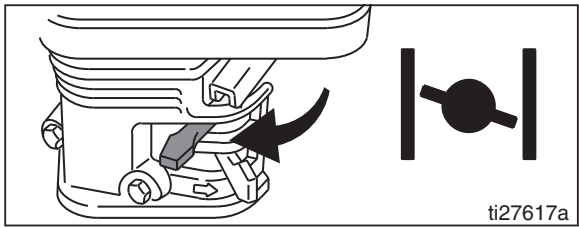

c. Set throttle to fast.

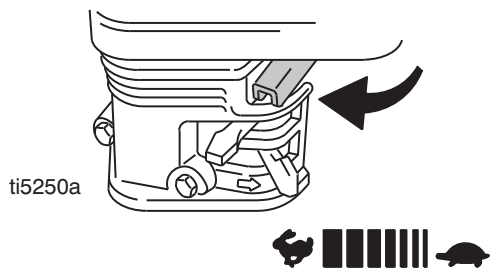

d. Set engine switch to ON.

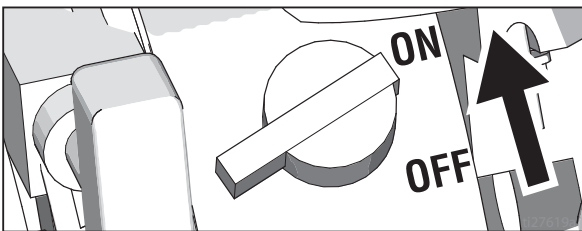

e. Pull starter cord.

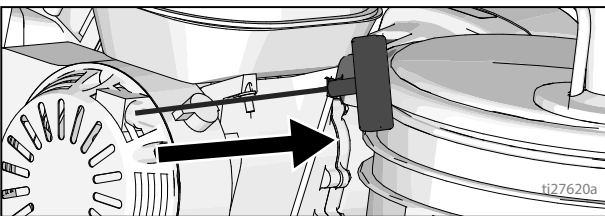

11. After engine starts, move choke to open.

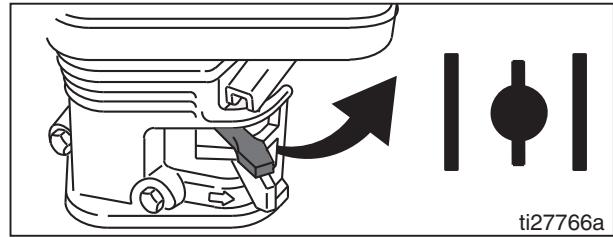

12. Set throttle to desired setting.

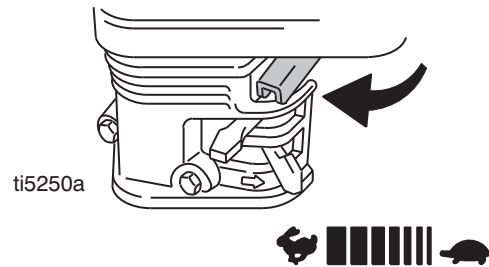

13. Set pump switch to **ON** (pump is now active).

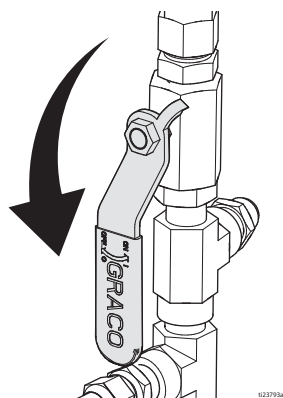

14. Increase pressure control enough to start pump. Allow fluid to circulate for 15 seconds.

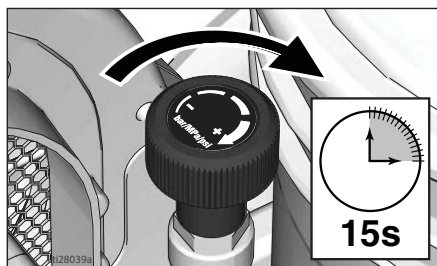

15. Turn pressure down, turn prime valve horizontal. Disengage gun trigger lock.

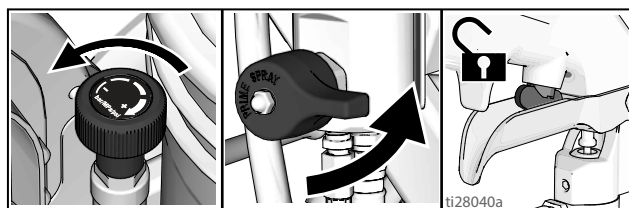

16. Hold all guns against a grounded metal flushing pail. Trigger guns and increase fluid pressure slowly until pumps run smoothly.

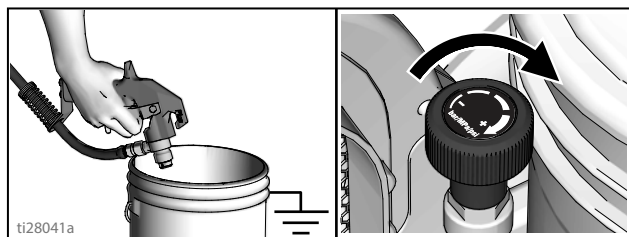

<p>High-pressure spray is able to inject toxins into the body and cause serious bodily injury. Do not stop leaks with hand or rag.</p>				

17. Inspect fittings for leaks. If leaks occur, turn sprayer **OFF** immediately. Perform **Pressure Relief Procedure**. Tighten leaky fittings. Repeat **Setup/Startup**, steps 1 - 17. If no leaks, continue to trigger gun until system is thoroughly flushed. Proceed to step 18.

18. Place siphon tube in paint pails.

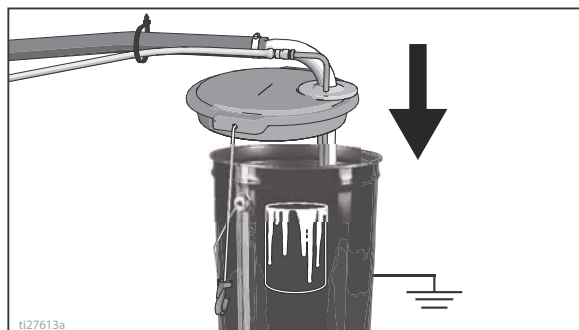

19. Trigger all guns again into a flushing fluid pail until paint appears. Assemble tips and guards.

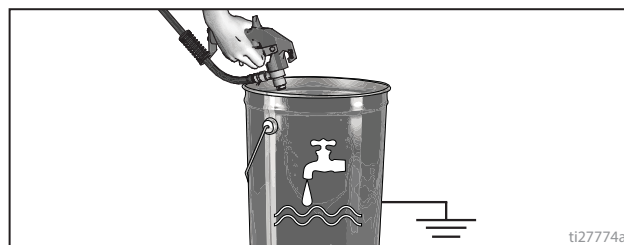

## SwitchTip and Guard Assembly

1. Engage trigger lock. Use end of SwitchTip to press OneSeal into tip guard, with curve matching tip bore.

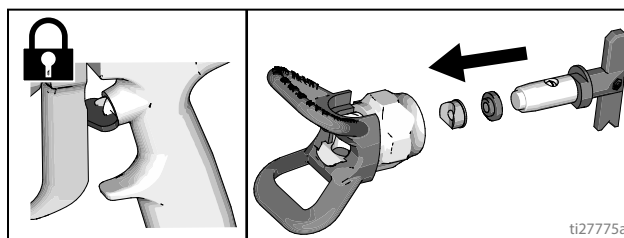

2. Insert SwitchTip in tip bore and firmly thread assembly onto gun.

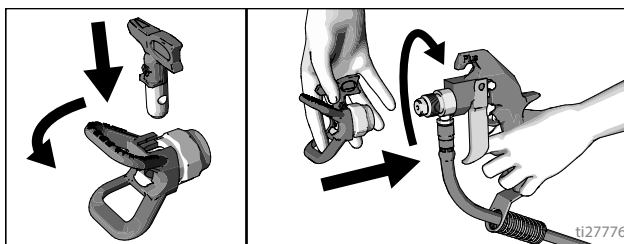

# Gun Placement

## Install Guns

1. Insert guns into gun holder. Tighten clamps.

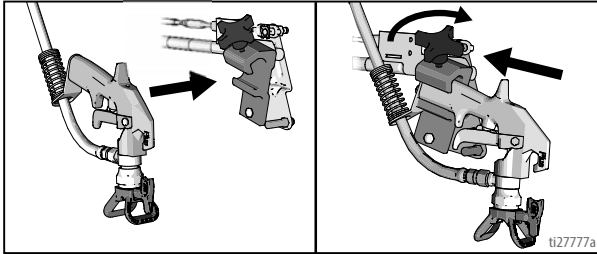

## Position Gun

2. Position gun: up/down, forward/reverse, left/right. See **Change Gun Position (Front and Back)**, page 14 and **Change Gun Position (Left and Right)**, page 15 for examples.

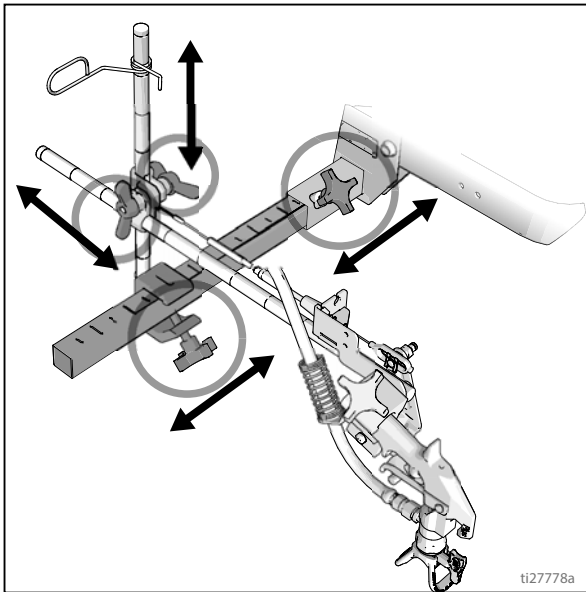

NOTE: When striping above a curb, the mounting clamp can be rotated for clearance.

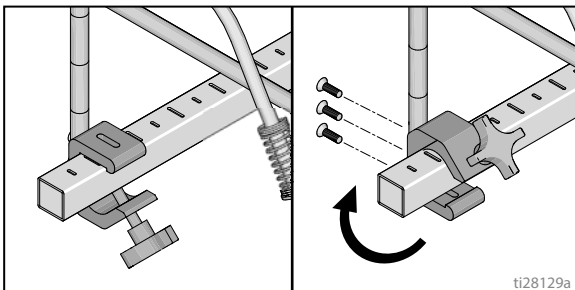

Another option can be to swing the gun out at an angle and rotate the tip guard. This results in better visibility for the user.

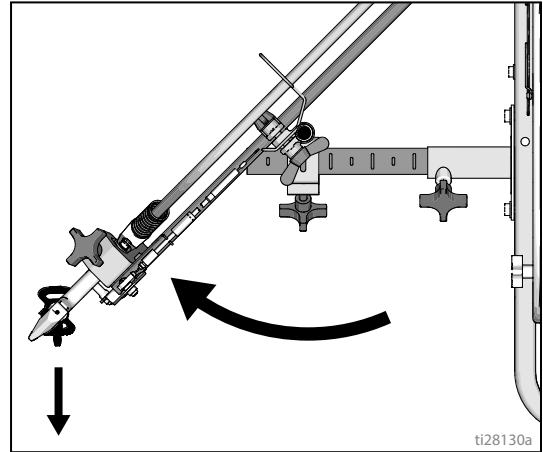

## Select Guns

3. Connect gun cables to left or right gun selector plates.

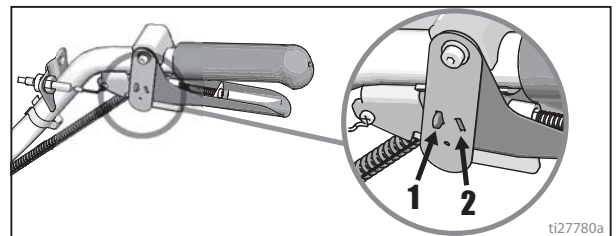

- a. One gun: Disconnect one gun selector plate from trigger.



- b. Both guns simultaneously: Adjust both gun selector plates to the same position.



- c. Solid-skip and skip-solid: Adjust solid-line gun to position 1 and skip-line to position 2.



# Gun Positions Chart

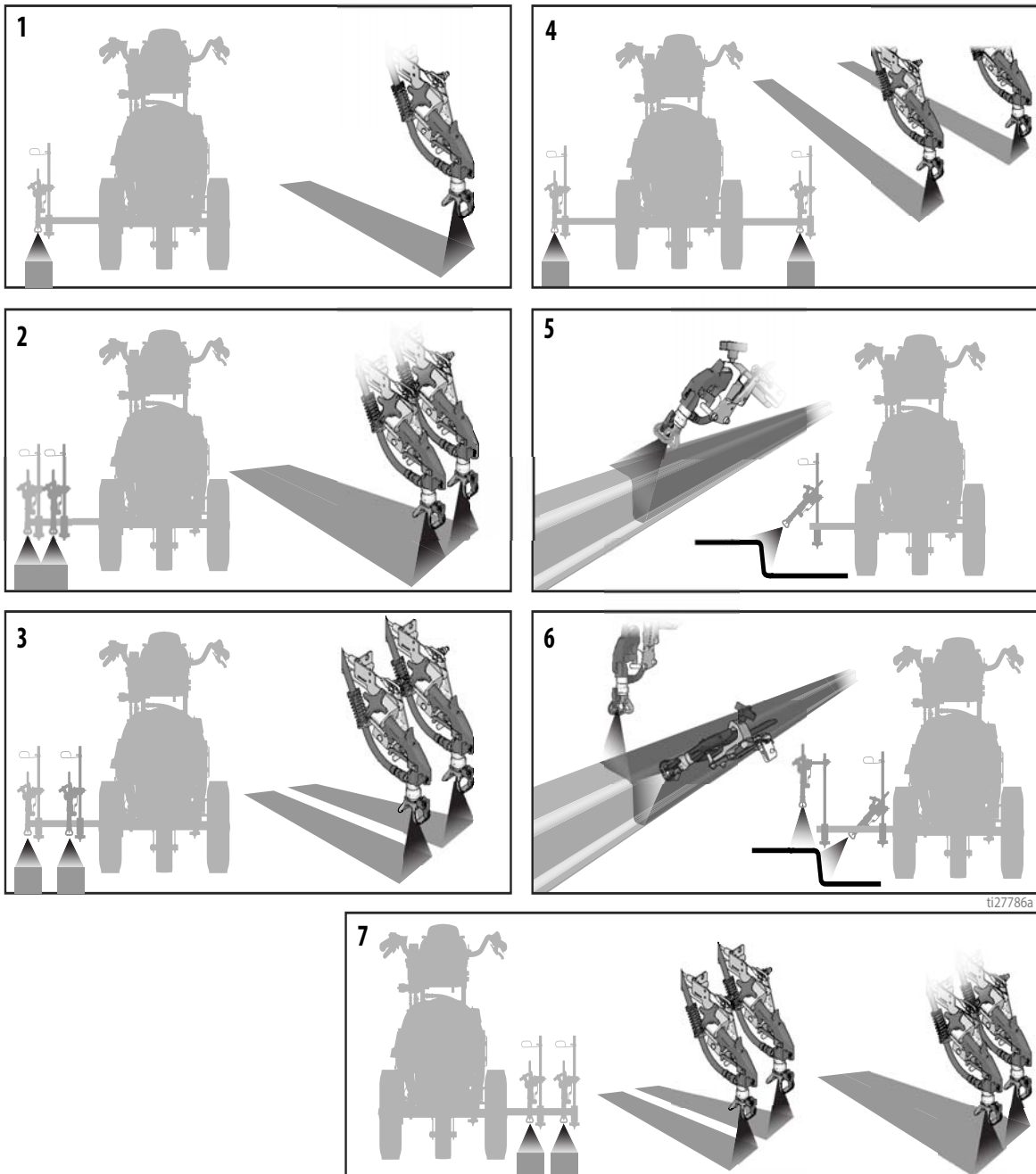

ti27786a

1	One line
2	One line up to 24 in. (61cm) wide
3	Two lines
4	One line or two lines to spray around obstacles
5	One gun curb
6	Two gun curb
7	Two lines or one line up to 24 in. (61 cm) wide

## Gun Arm Mounts

This unit is equipped with front and rear gun arm mounts.

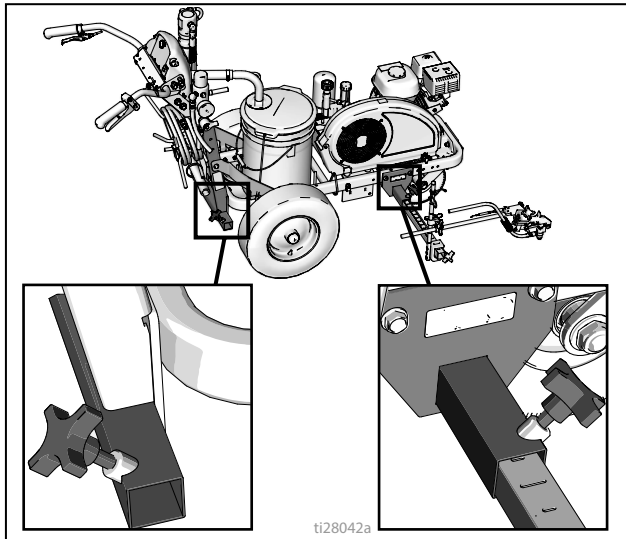

2. Slide gun arm assembly (including gun and hoses) out from gun arm mounting slot.

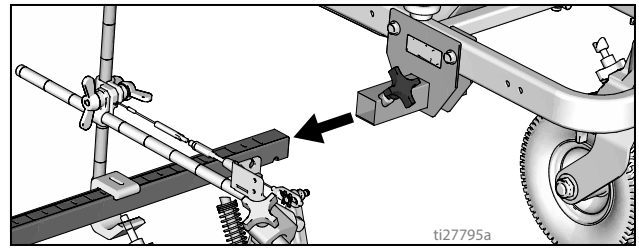

3. Slide gun arm assembly into desired gun arm mounting slot.

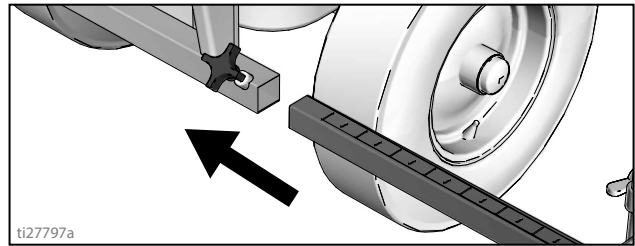

4. Tighten gun arm knob into gun arm mounting slot.

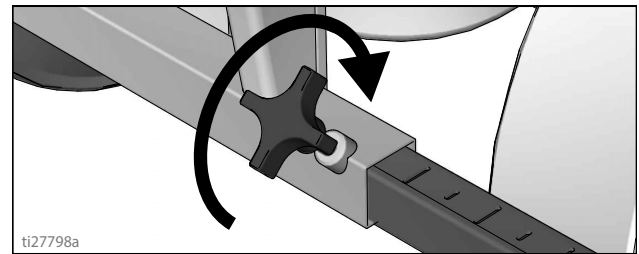

## Change Gun Position (Front and Back)

1. Loosen gun arm knob and remove from gun arm mounting slot.

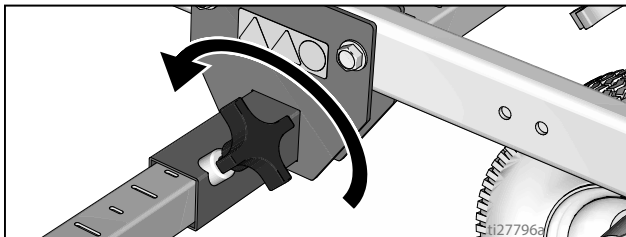

### NOTICE

Make sure all hoses, cables, and wires are properly routed through brackets and do NOT rub on tire. Contact with tire will result in damaged hoses, cables, and wires.

## Change Gun Position (Left and Right)

### Removal

1. Loosen vertical gun arm knob on gun arm mounting bar and remove.

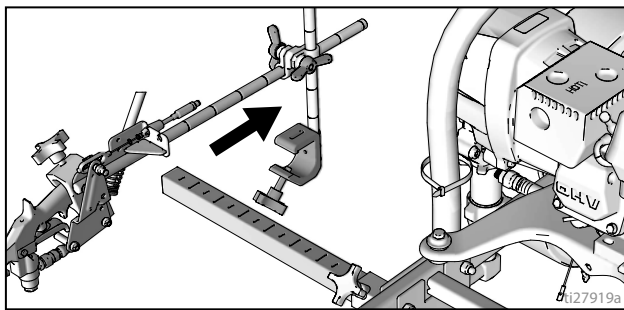
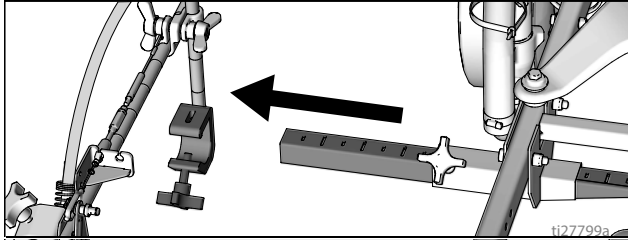

2. Extend mounting bar on opposite side of the machine.

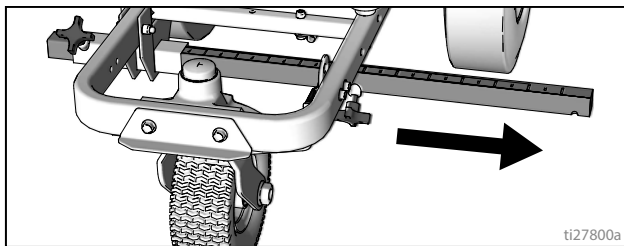

## Installation

1. Install vertical gun mount onto gun bar.

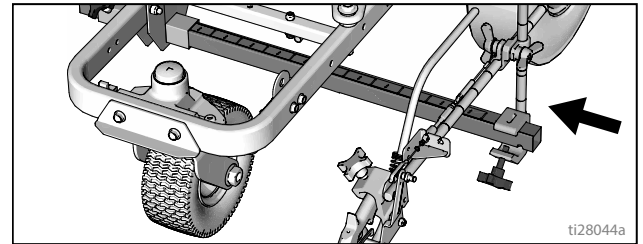

**NOTE:** Make sure all hoses, cables, and wires are properly routed through brackets.

## Gun Cable Adjustment

Adjusting the gun cable will increase or decrease the gap between the trigger plate and the gun trigger. To adjust trigger gap, perform the steps below.

1. Use wrench to loosen locking nut on cable adjuster.

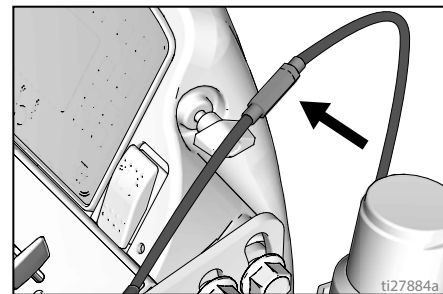

2. Loosen or tighten adjuster until desired result is achieved. **NOTE:** More thread exposed means less gap between gun trigger and trigger plate.
3. Use wrench to tighten locking nut on the adjuster.

## Straight Line Adjustment

The front wheel is set to center the unit and allow the operator to form straight lines. Over time, the wheel may become misaligned and will need to be readjusted. To re-center the front wheel, perform the following steps:

1. Loosen bolt on the front wheel bracket.

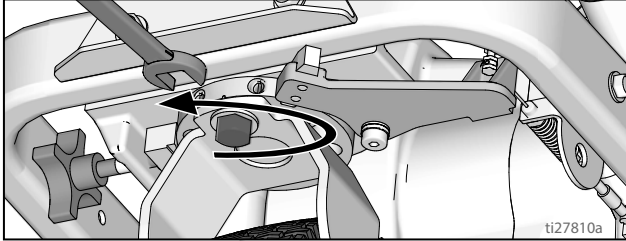

2. If striper arcs to the right, loosen left set screw and tighten right set screw for fine tune adjustment.

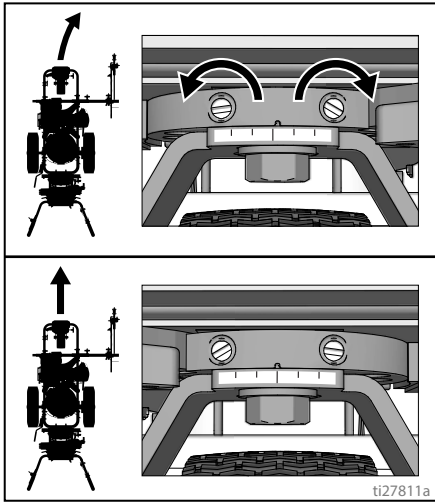

3. If striper arcs to the left, loosen right set screw and tighten left set screw.

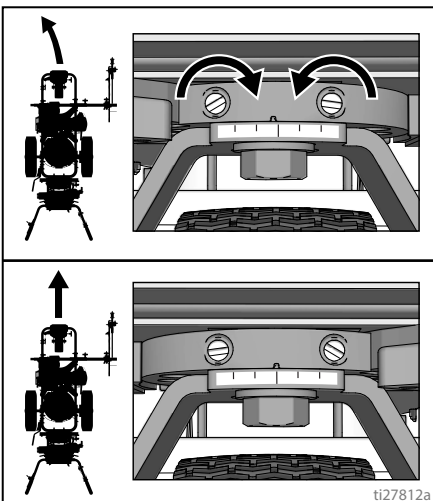

4. Roll the striper. Repeat steps 2 and 3 until striper rolls straight. Tighten bolt on wheel alignment plate to lock the new wheel setting.

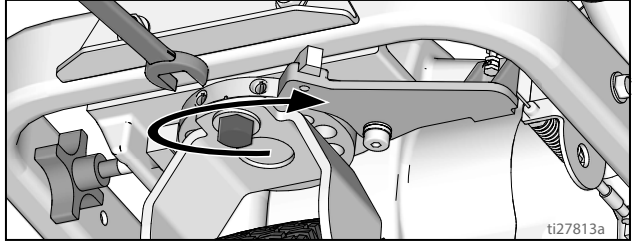

## Handle Bar Adjustment

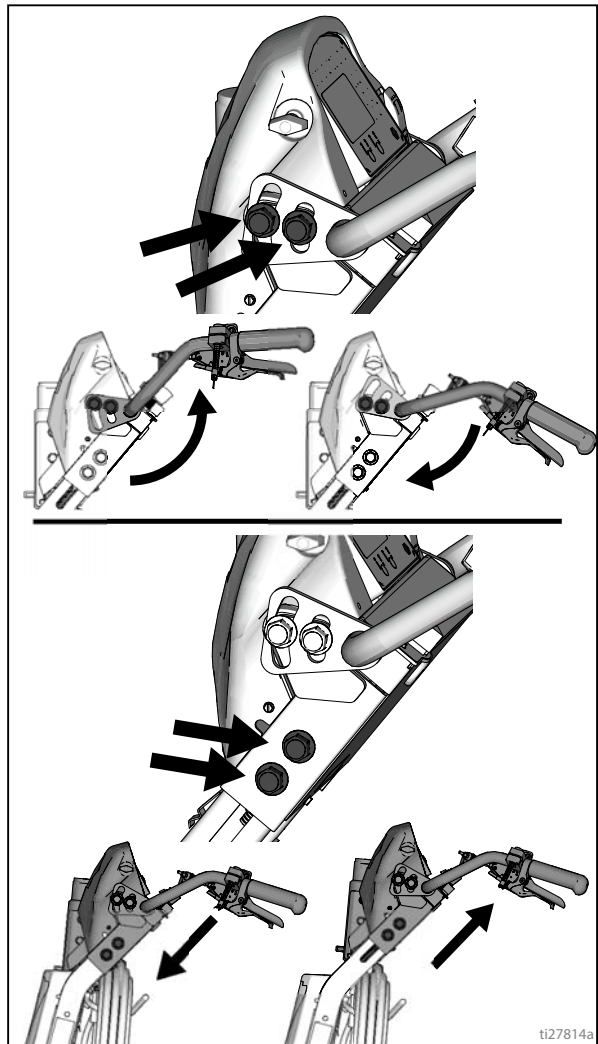



# Cleanup

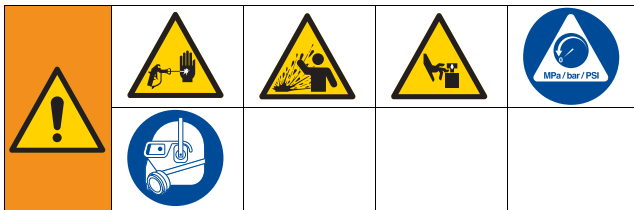

This equipment stays pressurized until pressure is manually relieved. To help prevent serious injury from pressurized fluid, such as skin injection, splashing fluid and moving parts, follow the Pressure Relief Procedure when you stop dispensing and before cleaning, checking, or servicing the equipment.

1. Perform **Pressure Relief Procedure**, page 8.
2. Remove guard and SwitchTip from all guns.

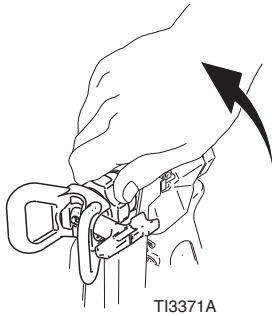

TI3371A

3. Unscrew cap, remove filter. Assemble without filter.

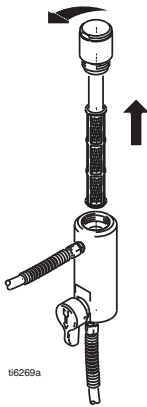

ti269a

4. Clean filter, guard and SwitchTip in flushing fluid.



TI3375A

FLUSH

5. Place siphon tube set in grounded metal pail partially filled with flushing fluid. Attach ground wire to true earth ground. Perform Startup steps 10 - 16 (see page 10) to flush out paint in sprayer. Use water to flush water-base paint and mineral spirits solvent (also called white spirit) to flush oil-base paint.
6. Hold gun against paint bucket and pull trigger until water or solvent appears.

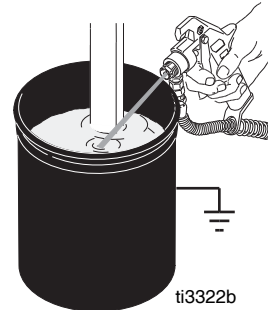

ti3322b

7. Move gun to solvent or water bucket. Hold gun against bucket and pull trigger until the system is thoroughly flushed.
8. Fill pump with Pump Armor and reassemble filter, guard and SwitchTip.
9. Each time you spray and store, fill throat packing nut with TSL to decrease packing wear.

# Maintenance

## LineLazer 130HS

### Periodic Maintenance

**DAILY:** Check engine oil level and fill as necessary.

**DAILY:** Check hydraulic oil level and fill as necessary.

**DAILY:** Check hose for wear and damage.

**DAILY:** Check gun safety for proper operation.

**DAILY:** Check prime/spray drain valve for proper operation.

**DAILY:** Check and fill gas tank

**DAILY:** Check that displacement pump is tight.

**DAILY:** Top off TSL level in displacement pump packing nut to help prevent material buildup on piston rod and early wear of packing.

**AFTER THE FIRST 20 HOURS OF OPERATION:** Drain engine oil and refill with clean oil. Reference Honda Engines Owner's Manual for correct oil viscosity.

**WEEKLY:** Remove engine air filter cover and clean element replace, if necessary. If operating in an unusually dusty environment, check filter daily.

**WEEKLY/DAILY:** Remove any debris from hydraulic rod.

**AFTER EACH 100 HOURS OF OPERATION:** Change engine oil. Reference Honda Engines Owner's Manual for correct oil viscosity.

**SEMI-ANNUALLY:** Check belt wear, replace if necessary.

**YEARLY OR 2000 HOURS:** Replace hydraulic oil and filter element with Graco hydraulic oil 169236 (5 gallon/18.9 liter) or 207428 (1 gallon/3.8 liter) and filter element 246173; page 21.

**SPARK PLUG:** Use only BPR6ES (NGK) or W20EPR--U (NIPPONDENSO) plug. Gap plug to 0.028 to 0.031 in (0.7 to 0.8 mm). Use spark plug wrench when installing and removing plug.

## Caster Wheel

1. Once each year, tighten nut under dust cap until spring washer bottoms out, then back off the nut 1/2 to 3/4 turn.
2. Once each month, grease the wheel bearing.
3. Check pin for wear. If pin is worn out, there will be play in the caster wheel. Reverse or replace the pin as needed.
4. Check caster wheel alignment as necessary. To align; page 16.

# Troubleshooting

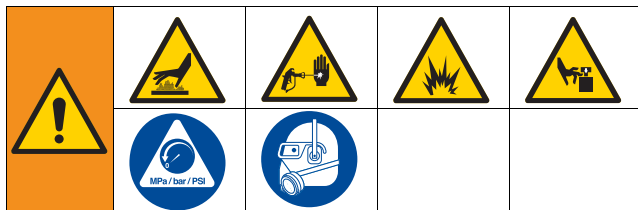

Problem	Cause	Solution
Gas engine pulls hard (won't start).	Hydraulic pressure is too high.	Turn hydraulic pressure knob counterclockwise to lowest setting.
Engine won't start.	Engine switch is OFF.	Turn engine switch ON.
	Engine is out of gas.	Refill gas tank. Honda Engines Owner's Manual.
	Engine oil level is low.	Try to start engine. Replenish oil, if necessary. Honda Engines Owner's Manual.
	Spark plug cable is disconnected or damaged.	Connect spark plug cable or replace spark plug.
	Cold engine.	Use choke.
	Fuel shutoff lever is OFF.	Move lever to ON position.
	Oil is seeping into combustion chamber.	Remove spark plug. Pull starter 3 to 4 times. Clean or replace spark plug. Start engine. Keep sprayer upright to avoid oil seepage.
Engine operates, but displacement pump does not operate.	Pump valve is OFF.	Turn pump valve ON.
	Pressure setting is too low.	Turn pressure adjusting knob clockwise to increase pressure.
	Fluid filter is dirty.	Clean filter.
	Tip or tip filter is clogged.	Clean tip or tip filter. Manual 311254.
	Displacement pump piston rod is stuck due to dried paint.	Repair pump. Manual 311845.
	Belt worn, broken or off pulley.	Replace.
	Hydraulic fluid too low.	Shut of sprayer. Add fluid*.
Displacement pump operates, but output is low on upstroke	Hydraulic motor not shifting.	Set pump valve OFF. Turn pressure down. Turn engine OFF. Pry rod up or down until hydraulic motor shifts.
	Piston ball is not seating.	Service piston ball. Manual 311845.
Displacement pump operates but output is low on downstroke and/or on both strokes.	Piston packings are worn or damaged.	Replace packings. Manual 311845.
	Strainer is clogged.	Clean strainer.
	O-ring in pump is worn or damaged.	Replace o-ring. Manual 311845.
	Intake valve ball is packed with material or is not seating properly.	Clean intake valve. Manual 311845.
	Engine speed is too low.	Increase throttle setting.
	Suction tube air leak.	Tighten suction tube.
	Pressure setting is too low.	Increase pressure.
	Fluid filter, tip filter or tip is clogged or dirty.	Clean filter.
Large pressure drop in hose with heavy materials.	Use larger diameter hose and/or reduce overall length of hose. Use of more than 100 ft of 1/4 in. hose significantly reduces performance of sprayer. Use 3/8 in. hose for optimum performance (22 ft minimum).	

\*Check hydraulic fluid level often. Do not allow it to become too low. Use only Graco approved hydraulic fluid.

<b>Problem</b>	<b>Cause</b>	<b>Solution</b>
Pump is difficult to prime.	Air in pump or hose.	Check and tighten all fluid connections.  Reduce engine speed and cycle pump as slowly as possible during priming.
	Intake valve is leaking.	Clean intake valve. Be sure ball seat is not nicked or worn and that ball seats well. Reassemble valve.
	Pump packings are worn.	Replace pump packings. Manual 311845.
	Paint is too thick.	Thin the paint according to the supplier's recommendations.
	Engine speed is too high.	Decrease throttle setting before priming pump.
High engine speed at no load.	Mis-adjusted throttle setting.	Reset throttle to 3700-3800 engine rpm at no load.
	Worn engine governor.	Replace or service engine governor.
Low stall or run pressure shown on display.	New pump or new packings.	Pump break-in period takes up to 100 gallons of material.
Excessive paint leakage into throat packing nut.	Throat packing nut is loose.	Remove throat packing nut spacer. Tighten throat packing nut just enough to stop leakage.
	Throat packings are worn or damaged.	Replace packings. Manual 311845.
	Displacement rod is worn or damaged.	Replace rod. Manual 311845.
Fluid is spitting from gun.	Air in pump or hose.	Check and tighten all fluid connections. Reprime pump.
	Tip is partially clogged.	Clear tip. Manual 311254.
	Fluid supply is low or empty.	Refill fluid supply. Prime pump. Check fluid supply often to prevent running pump dry.
Excessive leakage around hydraulic motor piston rod wiper.	Piston rod seal worn or damaged.	Replace these parts.
Fluid delivery is low.	Pressure setting too low.	Increase pressure.
	Displacement pump outlet filter (if used) is dirty or clogged.	Clean filter.
	Intake line to pump inlet is not tight.	Tighten.
	Hydraulic motor is worn or damaged.	Bring sprayer to Graco distributor for repair.
	Large pressure drop in fluid hose.	Use larger diameter or shorter hose.
The sprayer overheats.	Paint buildup on hydraulic components.	Clean.
	Oil level is low.	Fill with oil.
Excessive hydraulic pump noise.	Low hydraulic fluid level.	Shut off sprayer. Add fluid*

# Hydraulic Oil/Filter Change

## Removal

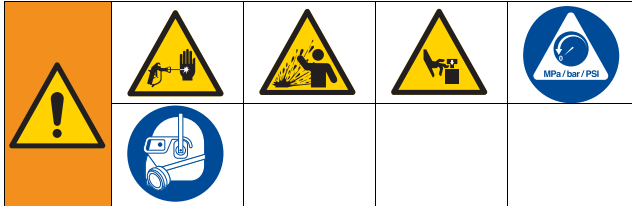

This equipment stays pressurized until pressure is manually relieved. To help prevent serious injury from pressurized fluid, such as skin injection, splashing fluid and moving parts, follow the Pressure Relief Procedure when you stop dispensing and before cleaning, checking, or servicing the equipment.

1. Perform **Pressure Relief Procedure**, page 8.
2. Place drip pan or rags under sprayer to catch hydraulic oil that drains out.
3. Remove drain plug. Allow hydraulic oil to drain.
4. Unscrew filter slowly - oil runs into groove and drains out rear.

## Installation

1. Apply a light film of oil on filter gasket. Install drain plug and oil filter. Tighten oil filter 3/4 turn after gasket contacts base.
2. Fill with five quarts of Graco hydraulic oil 169236 (5 gallon/20 liter) or 207428 (1 gallon/3.8 liter).
3. Check oil level.

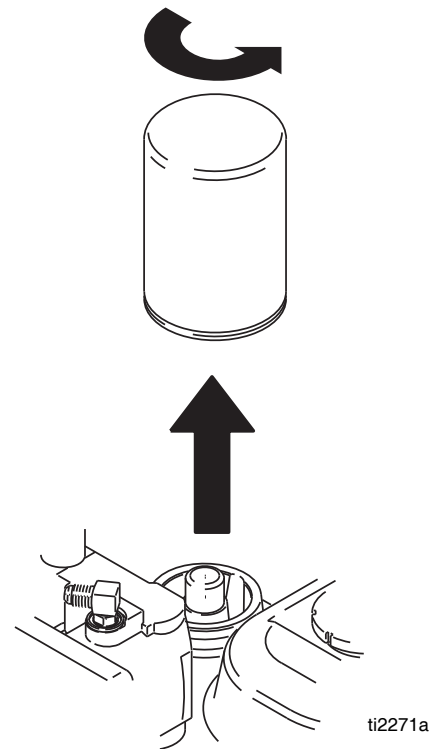

ti2271a

# Technical Data

<b>LineLazer 130HS</b>		
Engine	Honda GX120cc	
	<b>US</b>	<b>Metric</b>
Maximum fluid working pressure	3300 psi	(227 bar, 22.7 MPa)
Maximum free-flow delivery	1.3 gpm	4.9 lpm
Cycles per gallon/liter	85 cpg	22.5 cpl
Hydraulic reservoir capacity	1.25 gallons	(4.73 liters)
Hydraulic pressure	1825 psi	(124 bar)
<b>Maximum Tip Size</b>		
1 gun	0.037 in.	
2 guns	0.029 in.	
<b>Noise level (dBa)</b>		
Sound power	110 dBa per ISO 3744	
Sound pressure	96 dBa measured at 3.1 feet (1m)	
<b>Vibration level*</b>		
Left Hand	2.90 m/sec <sup>2</sup>	
Right Hand	2.83 m/sec <sup>2</sup>	
* Vibration measured per ISO 5349 based on 8 hr daily exposure		
<b>Inlet/Outlet Sizes</b>		
Inlet paint strainer	16 mesh (1190 micron) stainless steel screen, reusable	
Outlet paint filter	50 mesh (250 micron) stainless steel screen, reusable	
Pump inlet size	1 in. npsm(m)	
Fluid outlet size	3/8 npt(f)	
<b>Dimensions/Weight</b>		
Height	44.5 in.	113.03 cm
Length	68.25 in.	173.36 cm
Width	34.25 in.	87.0 cm
Weight (dry, without packaging)	263 lb	119 kg

Wetted parts...PTFE, Nylon, polyurethane, V-Max™  
 leather, tungsten carbide, stainless steel, chrome plating,  
 nickel-plated carbon steel, ceramic



# Graco Standard Warranty

Graco warrants all equipment referenced in this document which is manufactured by Graco and bearing its name to be free from defects in material and workmanship on the date of sale to the original purchaser for use. With the exception of any special, extended, or limited warranty published by Graco, Graco will, for a period of twelve months from the date of sale, repair or replace any part of the equipment determined by Graco to be defective. This warranty applies only when the equipment is installed, operated and maintained in accordance with Graco's written recommendations.

This warranty does not cover, and Graco shall not be liable for general wear and tear, or any malfunction, damage or wear caused by faulty installation, misapplication, abrasion, corrosion, inadequate or improper maintenance, negligence, accident, tampering, or substitution of non-Graco component parts. Nor shall Graco be liable for malfunction, damage or wear caused by the incompatibility of Graco equipment with structures, accessories, equipment or materials not supplied by Graco, or the improper design, manufacture, installation, operation or maintenance of structures, accessories, equipment or materials not supplied by Graco.

This warranty is conditioned upon the prepaid return of the equipment claimed to be defective to an authorized Graco distributor for verification of the claimed defect. If the claimed defect is verified, Graco will repair or replace free of charge any defective parts. The equipment will be returned to the original purchaser transportation prepaid. If inspection of the equipment does not disclose any defect in material or workmanship, repairs will be made at a reasonable charge, which charges may include the costs of parts, labor, and transportation.

**THIS WARRANTY IS EXCLUSIVE, AND IS IN LIEU OF ANY OTHER WARRANTIES, EXPRESS OR IMPLIED, INCLUDING BUT NOT LIMITED TO WARRANTY OF MERCHANTABILITY OR WARRANTY OF FITNESS FOR A PARTICULAR PURPOSE.**

Graco's sole obligation and buyer's sole remedy for any breach of warranty shall be as set forth above. The buyer agrees that no other remedy (including, but not limited to, incidental or consequential damages for lost profits, lost sales, injury to person or property, or any other incidental or consequential loss) shall be available. Any action for breach of warranty must be brought within two (2) years of the date of sale.

**GRACO MAKES NO WARRANTY, AND DISCLAIMS ALL IMPLIED WARRANTIES OF MERCHANTABILITY AND FITNESS FOR A PARTICULAR PURPOSE, IN CONNECTION WITH ACCESSORIES, EQUIPMENT, MATERIALS OR COMPONENTS SOLD BUT NOT MANUFACTURED BY GRACO.** These items sold, but not manufactured by Graco (such as electric motors, switches, hose, etc.), are subject to the warranty, if any, of their manufacturer. Graco will provide purchaser with reasonable assistance in making any claim for breach of these warranties.

In no event will Graco be liable for indirect, incidental, special or consequential damages resulting from Graco supplying equipment hereunder, or the furnishing, performance, or use of any products or other goods sold hereto, whether due to a breach of contract, breach of warranty, the negligence of Graco, or otherwise.

## Graco Information

For the latest information about Graco products, visit [www.graco.com](http://www.graco.com).

For patent information, see [www.graco.com/patents](http://www.graco.com/patents).

**TO PLACE AN ORDER**, contact your Graco distributor or call 1-800-690-2894 to identify the nearest distributor.

*All written and visual data contained in this document reflects the latest product information available at the time of publication. Graco reserves the right to make changes at any time without notice.*

Original instructions. This manual contains English. MM 3A3392

**Graco Headquarters:** Minneapolis

**International Offices:** Belgium, China, Japan, Korea

**GRACO INC. AND SUBSIDIARIES • P.O. BOX 1441 • MINNEAPOLIS MN 55440-1441 • USA**  
**Copyright 2016, Graco Inc. All Graco manufacturing locations are registered to ISO 9001.**

[www.graco.com](http://www.graco.com)

Revision B, April 2018