

Screening and Conveyor Solutions Trellex LS range



EN

Solutions
you can
count on



Trellex® is a registered trademark of Metso Corporation



Modular system

The Trellex® LS system is the result of more than 50 years of experience and development. This comprehensive modular system mounts lengthwise and is designed to fit virtually any screen, enabling higher volume processing with minimal interruptions.

The Trellex LS System is directly compatible with standard sub-frames used around the globe. The Trellex LS range is easily retrofitted to existing systems with no need to weld or cut steel rails. Several different profiled upgrade strips are included in the range to fit the majority of screens available on the market - simply fit them to the rail and then just add Trellex LS modules. In addition, several different side liner alternatives complement the side protection range.

The Trellex LS system has been designed for dependable operation, with lightweight rubber or polyurethane modules, easy snap-on connections and an emphasis on recyclability. A high open area for better performance was a key design issue during development.



Simplified module selection

The Trellex LS modular system consists of Trellex LS standard range and Trellex LS HiPer range designed to accommodate requirements in various areas of

use: availability, capacity and non-blinding.

A complete Trellex LS range:

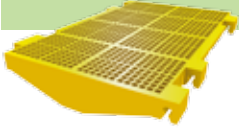
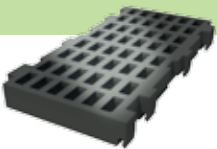
- Screen modules
- Sideliners/side wall protection
- Rails
- Upgrade strips
- Surface accessories

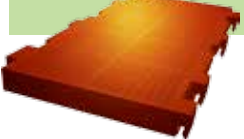
Trellex LS standard range	Trellex LS HiPer Flow	Trellex LS HiPer Life	Trellex LS HiPer Clean	Trellex LS HiPer Drain
Always available, quickly and conveniently wherever you are	At least 20% more active screening surface	Built tough for maximum load handling	Precision production without interruptions, guaranteed to stay clean	Precision and exceptional dewatering
Availability	Capacity	Lifetime, durability	Non-pegging, non-blinding	Precision, efficiency
				

Trellex LS Standard range

Trellex LS is our platform for modular screening. Its success is based on securing a complete range that meets all your needs in terms of cost, availability, module sizes, functions and more.

The width and depth of our Trellex LS range means we can meet all your production challenges. Our unique use of various materials coupled with modern and efficient production technologies creates solutions and opportunities that deliver on your high expectations.

Polyurethane modules are manufactured from open cast technology, predominantly with a dual hardness design for maximum life and performance. Injection-molded TPU for highest possible precision is also available.

Injection-molded wear-resistant rubber ensures consistent material performance properties in all rubber modules. Choose between punched or molded apertures. The Trellex LS system also includes a wide range of accessories for more effective throughput of fines.

Trellex LS modules help you max the volume while minimizing the downtime. Thanks to the industry's only true global sales and support network, Trellex LS modules are always available quickly and conveniently wherever you are. Make sure your screen is always producing at its cost-effective best. Match it with Trellex LS screening modules.

Trellex LS deck RU

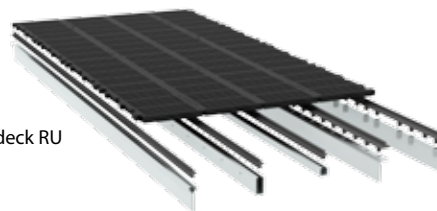

Trellex LS deck PU

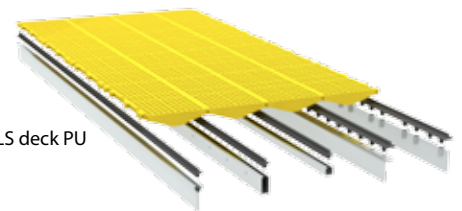



Trellex LS HiPer range

Give your screen the **highest performance** upgrade possible. HiPer is our most advanced product line, grouped into four top-performing series offering even more capacity, more efficient material screening and zero interruptions caused by pegging or blinding. And since they're designed, produced and delivered by Metso, you can plan your screening media system with a mix of Trellex LS standard and HiPer modules for maximum effectiveness and value.

Trellex LS HiPer Flow

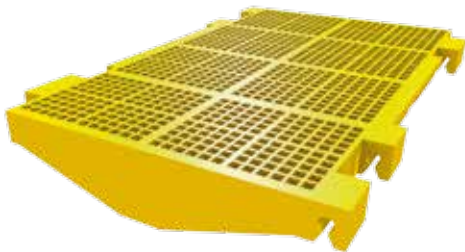

Trellex LS HiPer Flow modules have at least 20% more effective open area compared to corresponding LS standard modules. In performance terms, that means you get **at least 20% more active screening surface**. But LS HiPer Flow is much more than just an increased number of holes per module. It has been specially engineered using

dual hardness technology to ensure that the wider and more productive open area does not come at the expense of wear life. Combining LS HiPer Flow modules with LS Standard modules makes it possible to further optimize the flow, getting the most out of the screen application.

Trellex LS HiPer Life



Trellex LS HiPer Life is built tough for maximum load handling to offer exceptional wear resistance. The unique combination of injection-molded modules with molded apertures and rubber ensures high wear resistance and long wear life. Trellex LS HiPer Life modules last at least 30% longer

compared to standard LS. The LS HiPer Life modules are ideal for use in complete deck or in combination with LS standard modules for the highest possible cost effectiveness.



Trellex LS HiPer Clean



Trellex LS HiPer Clean modules deliver the precision you need when screening fine materials while limiting costly downtime. The unique combination of injection-molded modules with molded apertures and superior flexible rubber material ensures high efficiency with less pegging and blinding. LS HiPer Clean modules stay clean in the most challenging conditions, including during screening of high humidity materials.

Injection mold manufacturing technology ensures consistent material performance properties across the board. The ultra-flexible membrane material rotates effectively, increasing throughput of fines. The result is precision production without interruptions. Also available in 60° hardness for higher load capacity.

Trellex LS HiPer Drain

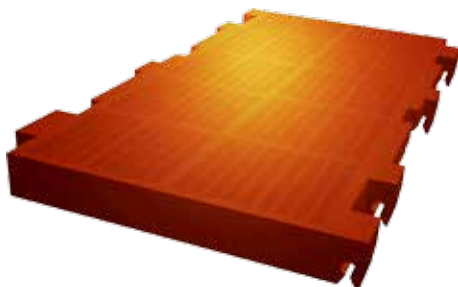

With Trellex LS HiPer Drain, you can count on precision performance and exceptional dewatering. All modules are made from injection-molded polyurethane with the highest possible accuracy in aperture size and module dimensions. That means higher screening precision and minimum risk of leakage. All openings are optimized

to give the highest possible dewatering efficiency. In order to cope with these tough applications, and with high bed depths, each module has a strong, reinforcing frame. Choose Trellex LS HiPer Drain when you want the highest possible precision in your dewatering application.

Selection guide

The selection guides allows you to compare and select products, bringing maximum value to your application.

	300/305LS Rubber	300/305LS Polyurethane	300/305LS HiPerClean	300/305LS HiPerFlow	305LS HiPerDrain	300/305LS HiPerLife
Max feed size range (mm)	20 - 200	20 - 75	2 - 50	2 - 40	2 - 30	20-250
Separation range (mm)	2 - 75	2 - 40	2 - 20	2 - 20	0,3 - 0,8	10-60
Max Drop Height (mm)	500	350	350	300	300	650
Applications	Allround wet/dry	Allround wet/dry	Construction - final screening	Construction - final screening	Aggregate dewatering	Secondary screens
			Fines removal / control screening	For high throughput requirements	Dense media circuits	Mill discharge screens
			High humidity feed - small separations			Screening abrasive material
Module Design	300x500 300x610 305x610	300x500 300x610 305x610	300x500 300x610 305x610	300x500 300x610 305x610	305x610	300x500 300x610 305x610
Aperture design	Molded or punched	Molded	Molded	Molded	Molded	Molded
Material	Wear-resistant rubber	Dual-hardness polyurethane	Flexible wear-resistant rubber	Dual-hardness polyurethane	Thermoplastic polyurethane	Extra wear-resistant rubber
Material hardness (Sh-A)	60	70, 80 or 90	40	70, 80 or 90	90	60
Total media build heights (mm)	30, 40 or 60	30	30 or 40	30	40	40 or 60
Attachment	snap-on	snap-on	snap-on	snap-on	snap-on	snap-on

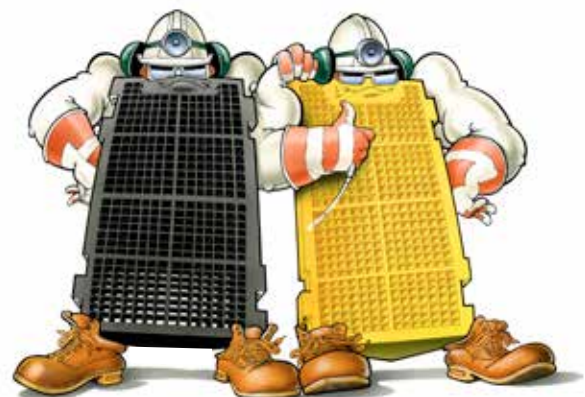

Side modules

Trellex LS-S side modules are available in a wide range of widths to complete installations on both metric and imperial screens. Available in widths between 100-400 mm.

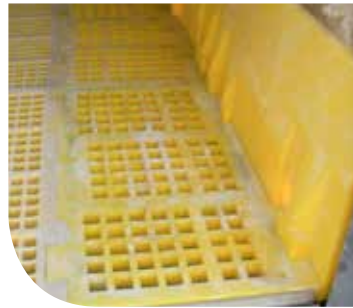

LS-S-290-500 wideside module, complete with ledge angle strip for correct mounting

Side wall protection

Side wall protection is required in all modular screen media installations. Depending on the type of screen and screen design, side wall protection is often a part of the attachment system.

There are several alternatives when it comes to height, thickness and material. The most common is wedge-down attachment, either with flat or chamfered top side. Wedge-down is standard on Metso screens.

Read more about the side wall protection in the following page.



PU sideliners with chamfer top for Metso MF, mining screens



PU sideliners for flat top for CVB or TS screens

Side wall protection

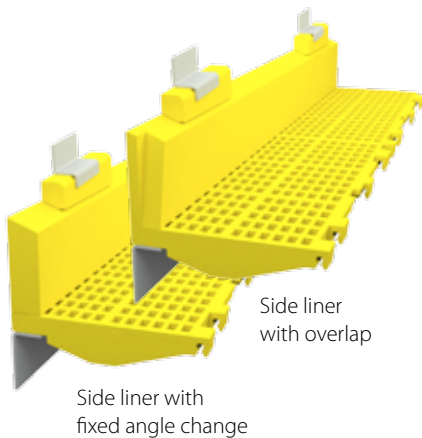

Side wall protection wedge-down side liners

- Standard design with overlap available in both rubber and polyurethane
- Suitable for multi-slope banana screens
- Can be used for feed box lining
- Side liners with fixed angle change available on request



Side wall protection grooved side liners

- Suitable for screens without ledge angle support
- Tailor made drilling of side liner to suit existing holes in screen box



Side wall protection snap-on side liners

- Snap-on side wall protection
- Installed direct on upgrade strip
- Independent of rail type



Longitudinal rails

Trellex SR rails

Metso screening media standard rails

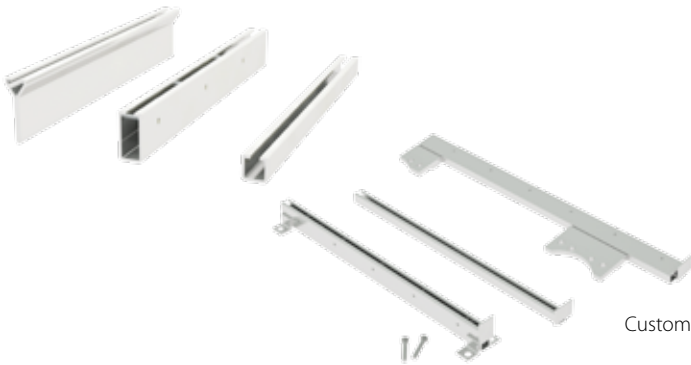

Screen modules are mounted on longitudinal rails with upgrade strips. There are various types and designs of rails available – some of the standard installations for Trellex LS are featured here.

All rails can be prepared and delivered as custom made parts to suit any screen machine or OEM specification. We can offer: Shot-blasting, anti-corrosive paint, galvanization, drilling and welding. Stop plate is essential and required.

Trellex PS rail

Metso screening media standard rail

PS rail standard full length or cutted to required length



PS rail customized with fixing holes



PS rail customized with fixing holes and end stop

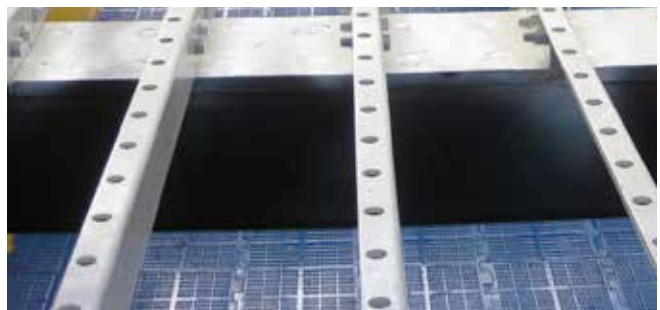

Upgrade strips

Trellex SR rails

- Injection-moulded
- Resistant to microbiological growth in environments with process water

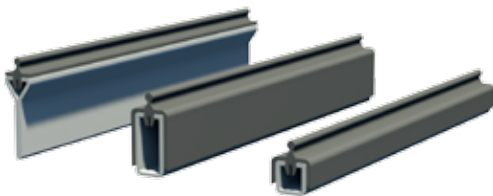

Upgrade strips are vital to the Trellex LS system. Using them means no drilling, cutting or welding is needed - which simplifies installation significantly.

Choosing the right upgrade strip is also easy, by identifying the existing supports and their design and simply matching up the appropriate version. The Trellex LS system range carries a complete setup of upgrade strips for common longitudinal supports.

The upgrade strips are principally manufactured of PU-quality, chosen for its resistance to the microbiological growths that can occur in some wet applications and cause deteriorating material properties.

Trellex PS rail

- Available in light duty, heavy duty and extra heavy duty strip



Other accessories

Ledge angle strips

- Available for all Metso screens and most of all other screens to optimize installation

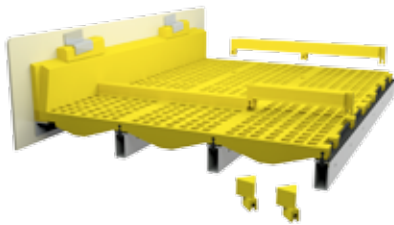

Surface features

- **Trellex LS Knock-In Dambar**
For dewatering and wet screening applications
- **Trellex LS Knock-In Deflector**
Directs the material into screening area
- **Trellex ABR (De Blinding Rods)**
Prevents your screendeck from blinding and pegging

Wire inserts

- Used when mixing synthetic and wire media





Metso Minerals (Sweden) AB
Screening and Conveyor Solutions
P.O. Box 132
SE-231 22 Trelleborg
Sweden
Phone: +46 410 525 00
Fax: +46 410 526 04
www.metsominerals.com

For contact or information about
your nearest sales office please visit:
www.metso.com

