

Instructions

Horizon™

FLUID MANAGEMENT SYSTEMS



308607J
EN

Used for bulk dispensing of petroleum and synthetic-based oils and antifreeze to multiple service bays.

NOTE: These instructions are for software version 1.05



Important Safety Instructions.

Read all warnings and instructions in this manual.
Save these instructions.

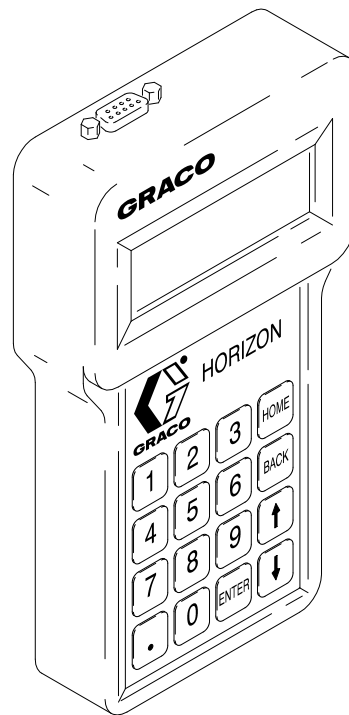

PROVEN QUALITY. LEADING TECHNOLOGY.



Table of Contents

Terms	3	- Diagnostics	26
Symbols	4	ABOUT Screen	26
Warning	4	POWER UP Screen	26
Symboles	5	SOLENOIDS Screen	26
Attention	5	METERS Screens	27
Pre-installation Checklist	6	Monitor Meters	27
Installation Checklist	8	Zero Meter Counters	27
Hardware Installation	8	KEYPAD Screen	27
Cable Routing and Connection	8	DIP SWITCHES Screen	27
System Startup	9	CLEAR PRINTER BUFFER Screen	28
Test the System	9	CAN Screens	28
Hardware Installation	10	MANUALLY TEST CAN	28
Flush System	10	CAN LEDs	28
Install Solenoids and Meters	10	TRANSACTION Screens	28
Set Control Module Addresses and Label Boxes	10	Setup - Modify or New Setup Options	
Change 110 VAC to 220 VAC	11	- Time and Date	29
Mount Control Module and Keypad Bracket	13	- Operator Access	29
Cable Routing and Connection	14	- Save Setup	29
Connect AC Electrical Power	14	- Important!	31
Route Solenoid and Meter Cables	15	- Control Modules	31
Connect Solenoid and Meter	15	Name Master Control Module	31
Connect Control Modules to CAN	16	Name Slave Control Modules	31
Connect Keypad Cable	17	- Fluids	32
Connect Printer or Computer	17	- Dispense Areas	33
Visually Check Wire Connections	17	- Connection Assignments	34
System Setup		- Meter Calibration	35
- Startup	19	- Inventory	36
Startup Screen	19	- Comm. on CM #1	37
Mode Selection (HOME)	19	- Run Options	38
Enter Password	19	- System Time-outs	39
Types of Setup	20	Printer and Computer Output	40
- Enable/Disable CAN Option	22	Computer: Receiving Horizon Data	43
- Modify or New Setup Options	22	Windows 3.1 Setup	43
NOTE: Setup instructions for individual options begins on page 29, with Time and Date Setup.		Windows 95 Setup	44
- Clear Setup Options	23	Run Mode	48
- Print Setup Options	24	- New Job	49
- Update Tables Options	25	Select New Job	49
		Enter Vehicle Data	49
		Dispense Request	50
		Preset Dispense	51
		Free Flow Dispense	51
		Dispense Confirmation	51
		Dispense	52
		- View Current Jobs	54
		- Report Jobs	55

Table of Contents

Inventory Mode	56	Steps For Configuring A System	83
- Tank Levels	57	System Design Suggestions	83
- History Totals	58	System Configuration Examples	84
- Report Inventory	59	Horizon Forms	85
- Save Inventory	60	Examples	86
Installation and		Blank Forms	97
Troubleshooting Tips	61	System Dynamics And Design Factors	104
- General Precautions	61	Pressure Relief Kit	104
- System Components and		Ability to Dispense Fluid During	
Installation Overview	61	System Failure	104
Control Module	61	Avoiding Pulsation When	
Programming Off-site	61	Simultaneous Dispensing Fluid	106
Keypad	62	Selecting a Supply Pump	106
Cabling	62	Technical Data	107
New Installation Startup	62	Graco Standard Warranty	108
Controller Area Network (CAN)	62	Graco Information	108
Control Module Address	62		
Installing and Troubleshooting a			
New Operating System Version	63		
Reboot After Setup or			
System Changes	63		
Printing Configuration	63		
- Troubleshooting System			
Components	64		
Controller Area Network (CAN)	64		
Solenoids	64		
Meters	65		
Printer	65		
- Possible Problems and Solutions	66		
Maintenance	69		
Shutdown Procedure	69		
Pulse Meter Service	70		
To Clean the Solenoid Valve	71		
Power Failure	71		
Control Module	71		
Clean The Keypad	71		
Install New Software	71		
Horizon System Components	72		
Control Modules	72		
Keypads	74		
Keypad Wall-mount Bracket	75		
Fluid Solenoid Valves	76		
Air Solenoid Valves	76		
Pulse Meters	77		
System Cables	77		
Pressure Relief Kit	80		
Fluid Check Valve	80		
40 Column Thermal Printer	80		
Appendix	81		
Horizon Software Features	82		
System Configuration	83		
Installation Considerations	83		

Terms

CAN: Controller Area Network; network that interconnects the control modules in the system.

Dispense Point: The combined designation of the dispense area and fluid number (usually specifies a hose reel with a dispense valve).

Fluid Zone: The groups of reels that share a pulse meter.

Keypad: Hand-held device with display screen and keys that communicates with the control module it is connected to.

Master Control Module: In addition to the functions of a *Slave Control Module*, it controls activity over the *CAN*, has additional memory, provides printer or computer interface, and continuously tracks the time and date.

Non-volatile Memory: Data is retained when the power is shut off.

Simultaneous Dispensing: The ability for more than one hose reel in the Horizon system to be dispensing fluid at the same time. The Horizon allows up to 12 dispenses to take place at a time.

Slave Control Module: Drives air and fluid solenoids and counts pulses of the meters that are connected to it.

Tables: Configuration information that is input during installation to customize the system.

Symbols

Warning Symbol



This symbol alerts you to the possibility of serious injury or death if you do not follow the instructions.

Caution Symbol



This symbol alerts you to the possibility of damage to or destruction of equipment if you do not follow the instructions.

! WARNING



FIRE, EXPLOSION, AND ELECTRIC SHOCK HAZARD

Improper grounding, poor air ventilation, open flames, or sparks can cause a hazardous condition and result in fire or explosion and serious injury.



- Ground the equipment. See **Connect AC Electrical Power to the Control Module**, page 14.
- Keep the dispense area free of debris, including solvent, rags, and gasoline.
- Do not smoke in the dispense area.
- If there is any static sparking while using the equipment, **stop dispensing immediately**. Identify and correct the problem.
- Keep liquids away from the electrical components.
- Disconnect electrical power at the main switch before servicing the equipment.



INSTRUCTIONS

EQUIPMENT MISUSE HAZARD

Equipment misuse can cause the equipment to rupture, malfunction, or start unexpectedly and result in serious injury.



- This equipment is for professional use only.
- Read all instruction manuals, tags, and labels before operating the equipment.
- Use the equipment only for its intended purpose. If you are uncertain about usage, call your Graco distributor.
- Do not alter or modify this equipment. Use only genuine Graco parts and accessories.
- Check the equipment daily. Repair or replace worn or damaged parts immediately.
- Do not exceed the maximum working pressure of the lowest rated system component. See the instruction manuals of the individual system components for their maximum working pressures.
- Do not stop or deflect fluid leaks with your hand, body, glove, or rag.
- Follow the **Shutdown Procedure** on page 69 whenever you stop dispensing; or clean, check, or service the equipment.
- Use fluids or solvents that are compatible with the equipment wetted parts. See the **Technical Data** section of all the equipment manuals. Read the fluid and solvent manufacturer's warnings.
- Comply with all applicable local, state and national fire, electrical and other safety regulations.

Symboles

Symbole de mise en garde



Ce symbole vous met en garde contre les risques de blessure grave ou de mort en cas de non-respect des consignes.

Symbole d'avertissement



Ce symbole avertit l'opérateur du risque de dégât ou de destruction du matériel en cas de non-respect des instructions.

ATTENTION



DANGER D'INCENDIE, D'EXPLOSION ET DE DÉCHARGE ÉLECTRIQUE

Si l'équipement n'est pas convenablement relié à la terre et si les locaux sont mal ventilés, des flammes ou des étincelles peuvent générer des situations dangereuses et provoquer un incendie ou une explosion avec risque de blessure grave.



- Relier l'équipement à la terre. Voir **Branchement de l'alimentation sur le module de commande CA**, page 14.
- Tenir la zone de distribution propre et exempte de tout résidu, p. ex: solvant, chiffons et essence.
- Ne pas fumer dans la zone de distribution.
- S'il se produit de l'électricité statique en utilisant le matériel, **arrêter la distribution immédiatement**. Identifier la cause et remédier à l'incident.
- Maintenir tout liquide à l'écart des composants électriques.
- Couper l'alimentation électrique à l'interrupteur principal avant de mettre l'équipement en marche.



INSTRUCTIONS



DANGER DE MAUVAISE UTILISATION DU MATÉRIEL

Toute mauvaise utilisation de l'équipement peut occasionner la rupture, un dysfonctionnement ou un démarrage inopiné et provoquer des blessures graves.

- Ce matériel est destiné à un usage uniquement professionnel.
- Lire tous les manuels d'instruction, panneaux et étiquettes avant de mettre le matériel en service.
- Utilisez ce matériel seulement pour l'usage auquel il est destiné. En cas de doute, appelez votre distributeur Graco.
- Ne pas altérer ou modifier ce matériel. N'utiliser que des pièces et accessoires Graco.
- Vérifier le matériel quotidiennement. Réparer ou remplacer les pièces usagées ou endommagées immédiatement.
- Ne pas dépasser la pression de service maximum de l'élément le plus faible du système. Voir les instructions figurant dans les manuels des éléments individuels du système pour connaître leurs pressions maximum de service.
- Ne pas arrêter ni dévier les fuites de produit avec la main, le corps, un gant ou un chiffon.
- Suivre la **procédure d'arrêt**, page 69 lors de chaque arrêt de pulvérisation, nettoyage, vérification ou entretien de l'équipement.
- S'assurer que les produits utilisés sont compatibles avec les pièces en contact avec le produit. Se reporter aux **Caractéristiques techniques** de tous les manuels du matériel. Lire les mises en garde du fabricant de produit.
- Toujours respecter les législations locales, fédérales, et nationales applicables en matière d'incendie, d'électricité, et de sécurité.

Pre-installation Checklist

CAUTION

Accurately and thoroughly document the Control Module port connections and dispense areas. If the Software Map does not exactly match the way the cables are connected, the system will not operate properly. Errors that could occur include: inability to turn on a fluid at a given dispense area; the wrong fluid or dispense point is activated; or a fluid dispense point is properly activated, but the wrong meter is monitored so the dispense job will not shut off properly.

This process is not difficult, but it is detailed and precise. Follow all steps and document them according to this manual to ensure a successful installation.

NOTE:

- Follow these steps before beginning to install the Horizon system.
- Refer also to **Installation and Troubleshooting Tips**, beginning on page 61, for information that will help you avoid installation problems and correct any problems that may occur.

✓	Pre-installation Steps	Reference
	1. Locate the Floor Plan, System Map (diagram of component locations), and all other documentation used to specify the system prior to ordering it. If this information cannot be located, recreate it from the packing slip that came with the system.	Packing slip and Appendix, pages 81–106
	2. Verify that all the parts on the Floor Plan match the parts shipped to you.	Floor Plan, purchase order, and packing slip
	3. Verify that all Horizon system components are marked in their proper locations on the Floor Plan.	Floor Plan
	4. Assign a name and number to all the control modules in the system. Record the control module numbers on the Floor Plan. <ul style="list-style-type: none"> • The Master Control Module (which the Administrative Keypad and printer or computer connect to) is always assigned number 1. • Additional Slave Control Modules are numbered in sequence as 2, 3, etc. • The control modules do not have to be in numerical order along the network cable. 	Floor Plan
	5. Assign a name and number to each dispense area. Record the names and numbers on the Floor Plan. <ul style="list-style-type: none"> • The dispense area usually consists of banks of hose reels, but may also consist of oil bars or individual hoses. • The names should make sense to the shop personnel who will use the system. For example: <i>Fast Lube</i>, <i>Service Bay 3</i>, etc. 	Floor Plan
	6. Within each dispense area, verify that the Floor Plan shows the fluid that each reel or hose should dispense.	Floor Plan

Pre-installation Checklist

✓	Pre-installation Steps	Reference
	<p>7. Repeat the following steps for each control module:</p> <p>a. For each solenoid attached to the control module, assign one port number, from 1 to 6. Record the port number and whether it is an air or fluid solenoid on the Floor Plan. NOTE: Air and fluid solenoids can be inter-mixed on the Horizon ports.</p> <p>b. For each meter attached to the control module, assign one port number, from 7 to 12. Record the port number on the Floor Plan. NOTE: More than one dispense point (reel, oil bar, hose, etc.) can share a meter.</p> <p>⚠ CAUTION: Record all the information carefully as it must be accurately entered during software setup.</p>	Floor Plan
	<p>8. Record the system data from the Floor Plan to the corresponding Pre-installation Forms. The completed forms will ease system setup by placing the information in the order the software will request the input. To ease software setup, keep the items in numerical order.</p> <p>Pre-installation Forms</p> <p>Form #1: User Name, PIN Number, and Access Level Form #2: Control Module and Fluid: Names and Numbers Form #3: Dispense Area Names and Numbers Form #4: Connection Assignments Form #5: Meter Calibration Chart Form #6: Warranty Registration and Checkout Form</p>	Floor Plan and Forms 1–6; see examples of forms on pages 86–96
	<p>9. Make sure the following tools are available for the system installation:</p> <ul style="list-style-type: none"> ● Drill, drill bit, and anchors to mount the control modules and keypad brackets on the walls or beams ● Wire cutter ● Wire stripper (wire gauge ranges between 18 and 22 AWG) ● Small, slotted screwdriver ● VOM (volt-ohmmeter) or multimeter to check cable continuity, input voltage, etc. 	
	<p>10. You are now ready to install the system. See the Installation Checklist on page 8.</p>	

Installation Checklist

NOTE:

- After completing the **Pre-installation Checklist** on page 6, use the following installation checklist to guide you through the steps of the system installation.
- Refer also to **Installation and Troubleshooting Tips**, beginning on page 61, for information that will help you avoid installation problems and correct any problems that may occur.

Hardware Installation

✓	Installation Steps	Reference
	1. Flush all fluid lines to remove the debris and avoid clogs in the meters.	
	2. Install the solenoids and meters in the fluid and air systems.	Floor plan, Appendix (pages 104–106), and solenoid and meter manuals
	3. Set the control module addresses with the DIP switches and label each control module.	Floor plan and page 10
	4. If the electrical input is 220 VAC, rewire the transformer.	Page 11
	5. Mount each control module and keypad bracket in its assigned location.	Floor plan and page 13

Cable Routing and Connection

✓	Installation Steps	Reference
	6. Route and connect the AC power to each control module. Do not turn on the power yet!	Floor plan and page 14
	7. Route the solenoid and meter cables to their assigned control module.	Floor plan
	8. Connect each solenoid and meter cable to the proper connector/port in the assigned control module.  CAUTION: Observe the proper polarity of meter connections or the meter will be damaged.	Floor plan and page 15
	9. Route the CAN network cable between the control modules. Connect the cable to the proper control module connectors. Remove the terminating resistor from the connectors of the control modules that are in the middle of the network chain.	Floor plan and page 16
	10. Route and connect the keypad cables between the keypads and the control modules.	Floor plan and page 17
	11. Route and connect the printer or computer cable between the Master Control Module and the printer or computer.	Page 18
	12. Visually check that all wiring is connected correctly. Compare the wiring to the diagrams in this manual.	Pages 14–17

Installation Checklist

System Startup

✓	Installation Steps	Reference
	13. Turn on the printer or computer.	
	14. Turn on the AC power to each control module. All the keypads should briefly display a revision screen and then the HOME screen. The printer should print "WELCOME TO HORIZON..." If the HOME screen is not displayed and/or there is no print-out, see Troubleshooting , page 68.	Page 19
	15. Using the Administrative Keypad, which is connected to the Master Control Module, access the Setup screens. The Password is 1111 for a new system installation.	Page 19
	16. <i>If your system has one control module only</i> , disable the CAN network.	Page 21
	17. Select CLEAR SETUP to initialize the system. Be sure to enter a new password for setup access before exiting Setup.	Page 23
	18. Using the administrative keypad, connected to the Master Control Module, complete the System Setup. Use the six forms that were filled out in the Pre-installation Procedure (refer to step 8, page 7) to enter the System Map information into the Setup screens.	Pre-installation Forms and Appendix, pages 86-95, or page 22, New Setup Options
	19. After entering all the setup data, reboot the system (turn the main power off then on) to initialize the software.	

Test the System

✓	Installation Steps	Reference
	20. Request a dispense job for each fluid to each location. If any problems occur, see Diagnostics , page 26, and troubleshooting information on page 61.	Pages 48 - 52
	21. Select SETUP→PRINT SETUP→ALL MEMORY to print a record of all the data entered during Setup. Send a copy of this record and all other required documents as instructed in Pre-installation Form 6, <i>Warranty Registration & Checkout Form</i> .	Pages 24 and 96

System Installation Complete

Hardware Installation

⚠ CAUTION

It is important to follow the floor plan or note any deviations as the software addresses will be setup according to what the floor plan shows. If addresses and physical connections do not match, the system will not operate properly.

1. Flush the System

Flush the fluid lines thoroughly to remove any particles that could clog the meters.

2. Install Solenoids and Meters

⚠ WARNING



A Pressure Relief Kit is required in the Horizon system to reduce the risk of serious injury, caused by splashing fluid in the eyes or on the skin resulting from component rupture from over-pressurization. See Fig. 20, page 104. See page 80 to order the kit.

Install the fluid system with the meters and solenoids in their designated locations. Install pressure relief kits, check valves, ball valves, fluid filters and other accessories that are shown in the floor plan. Refer to Appendix, pages 104 to 106.

3. Set Control Module Addresses and Label the Boxes

⚠ CAUTION

Each control module must have a unique binary number address, set by the DIP switches. Once the dip switch values are set, they must match the values entered for each control module during setup.

Each packet of information sent through the network contains the unique address of the control module the information is intended for. If the DIP switches are not set to the correct address, the control module will not receive its information. If two control modules have the same address, both of them will receive the information and try to act on it, resulting in system errors and incorrectly dispensed jobs.

NOTE:

- Refer to the Detail drawing of the DIP switches in Fig. 1.
 - See page 73 for the location of the DIP switches in the control module.
1. The Master Control Module is always number 1; do not change its address.
 2. All Slave Control Modules are shipped with their address set to 0. Set the DIP switches for each Slave Control Module to an address from 2 to 40.

DIP switches 1 to 6 are used to set the control module addresses; see the chart on page 11.
 3. Place a number label on the box that matches its address number.
 4. DIP switch 7 is used to tell the control module whether a basic keypad or enhanced or administrative keypad is connected to it. The OFF position indicates a basic keypad is connected. The ON position indicates an enhanced or administrative keypad is connected.
 5. DIP switch 8 should be in the ON position for normal system operation. The OFF position turns on all six solenoid drivers in the control module. This option can be used when there is a system failure and fluids need to be dispensed. The monitoring and controlling of dispensed fluids is disabled when the switch is in the OFF position.

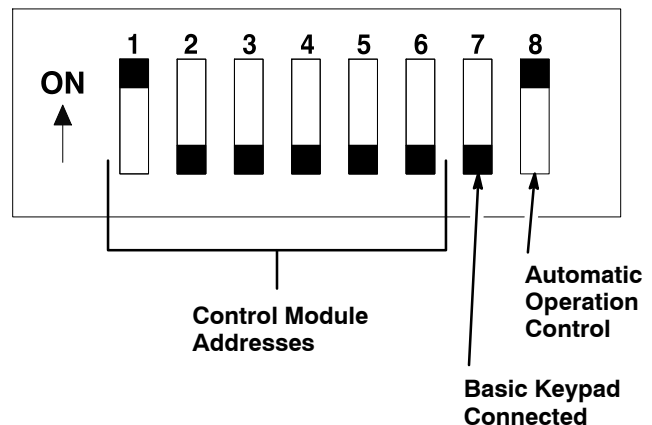

Fig. 1

06651

Hardware Installation

3. Set Control Module Addresses and Label the Boxes (continued)

DIP Switch No.	1	2	3	4	5	6	Address
Setting	OFF	OFF	OFF	OFF	OFF	OFF	0*
	ON	OFF	OFF	OFF	OFF	OFF	1
	OFF	ON	OFF	OFF	OFF	OFF	2
	ON	ON	OFF	OFF	OFF	OFF	3
	OFF	OFF	ON	OFF	OFF	OFF	4
	ON	OFF	ON	OFF	OFF	OFF	5
	OFF	ON	ON	OFF	OFF	OFF	6
	ON	ON	ON	OFF	OFF	OFF	7
	OFF	OFF	OFF	ON	OFF	OFF	8
	ON	OFF	OFF	ON	OFF	OFF	9
	OFF	ON	OFF	ON	OFF	OFF	10
	ON	ON	OFF	ON	OFF	OFF	11
	OFF	OFF	ON	ON	OFF	OFF	12
	ON	OFF	ON	ON	OFF	OFF	13
	OFF	ON	ON	ON	OFF	OFF	14
	ON	ON	ON	ON	OFF	OFF	15
	OFF	OFF	OFF	OFF	ON	OFF	16
	ON	OFF	OFF	OFF	ON	OFF	17
	OFF	ON	OFF	OFF	ON	OFF	18
	ON	ON	OFF	OFF	ON	OFF	19
	OFF	OFF	ON	OFF	ON	OFF	20
	ON	OFF	ON	OFF	ON	OFF	21
	OFF	ON	ON	OFF	ON	OFF	22
	ON	ON	ON	OFF	ON	OFF	23
	OFF	OFF	OFF	ON	ON	OFF	24
	ON	OFF	OFF	ON	ON	OFF	25
	OFF	ON	OFF	ON	ON	OFF	26
	ON	ON	OFF	ON	ON	OFF	27
	OFF	OFF	ON	ON	ON	OFF	28
	ON	OFF	ON	ON	ON	OFF	29
	OFF	ON	ON	ON	ON	OFF	30
	ON	ON	ON	ON	ON	OFF	31
	OFF	OFF	OFF	OFF	OFF	ON	32
	ON	OFF	OFF	OFF	OFF	ON	33
	OFF	ON	OFF	OFF	OFF	ON	34
	ON	ON	OFF	OFF	OFF	ON	35
	OFF	OFF	ON	OFF	OFF	ON	36
	ON	OFF	ON	OFF	OFF	ON	37
	OFF	ON	ON	OFF	OFF	ON	38
	ON	ON	ON	OFF	OFF	ON	39
OFF	OFF	OFF	ON	OFF	ON	40	

* Slave Control Modules are shipped with their address set to 0.

4. To Change from 110 VAC to 220 VAC

WARNING

FIRE, EXPLOSION, AND ELECTRIC SHOCK HAZARD

To reduce the risk of fire, explosion, and electric shock all wiring must be done by a qualified electrician.

- a. Power should not be connected at this point of installation if the procedure is being followed properly. Make sure there is no power to the control module(s).
- b. See Fig. 2 wire connections for 110 VAC. Cut the white wire connecting transformer terminals 2 to 6 at the terminal 2 connector.
- c. Cut the black wire connecting transformer terminals 1 to 5 at the terminal 1 connector.
- d. Switch the connectors on terminals 2 and 6. See Fig. 2 wire connections for 220 VAC.
- e. Strip 0.25 in. (6.4 mm) of insulation from the wires connected to terminals 2 and 5. Connect the wires together with a wire nut.

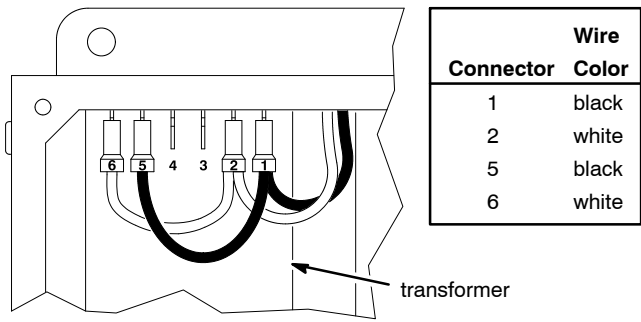

Connector	Wire Color
1	black
2	white
5	black
6	white

110 VAC Connection

06652

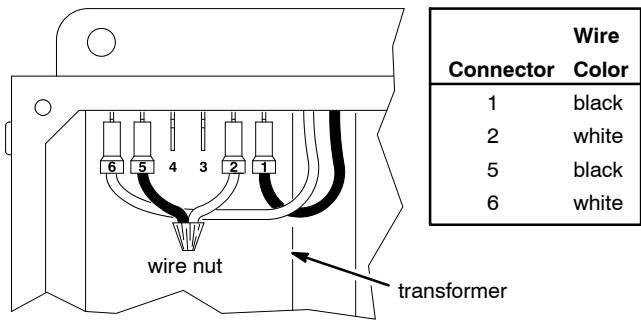

Connector	Wire Color
1	black
2	white
5	black
6	white

220 VAC Connection

06897

Fig. 2

Hardware Installation

5. Mount the Control Module and Keypad Bracket

Control Module

- The control module(s) should be mounted near the hose reels. Control modules can be mounted on the wall or at ceiling level.
- Locate the control module(s) as directed in the floor plan, being sure to follow the cable length and other configuration requirements.
- The mounting surface must be able to support the weight of the control module, 14 lbs. (6.3 kg). Use wall anchors if necessary.
- See Fig. 3 for the mounting hole layout.

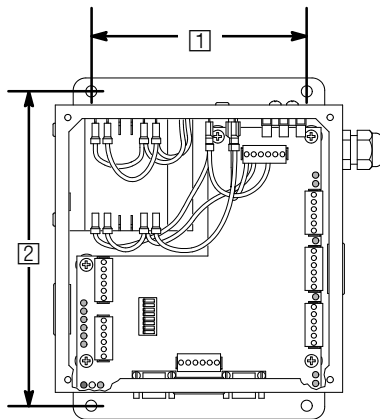

- 1 6 in. (152.4 mm)
- 2 8.75 in. (222.3 mm)

Fig. 3

06799

Keypad Bracket

See Fig. 4 for the mounting hole layout.

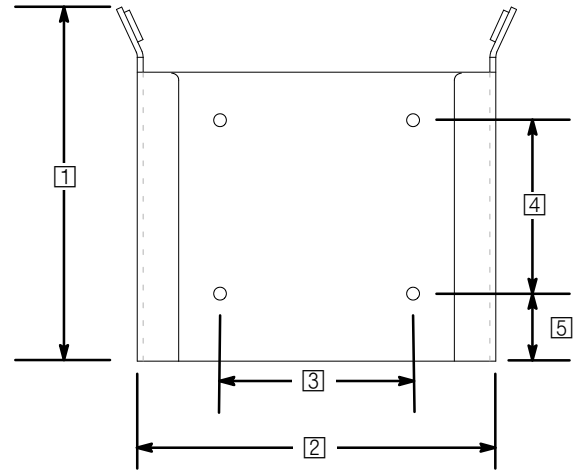

- 1 3.44 in. (87.4 mm)
- 2 3.66 in. (93.0 mm)
- 3 1.97 in. (50.0 mm)
- 4 1.77 in. (45.0 mm)
- 5 0.62 in. (15.7 mm)

Fig. 4

Cable Routing and Connection

6. Connect the AC Electrical Power to the Control Module

WARNING



FIRE, EXPLOSION, AND ELECTRIC SHOCK HAZARD

To reduce the risk of fire, explosion, and electric shock:

- All wiring must be done by a qualified electrician.
- Ground the Horizon system by connecting the electrical power cable to a true earth ground.

Wire the control module(s) into the facility's electrical system. It is recommended that the system be wired to a separate circuit breaker. This will help prevent accidental shutdown of the system and make it easier to power off the system when necessary. The system is designed to remain powered-up continuously during normal operation.

To ease system maintenance, install a switch for turning off the power at each control module. Locate the switches near each control module, but out of reach from the floor to prevent accidental shutoff of power to the control module.

Connect the power cable to the control module as shown in Fig. 5.

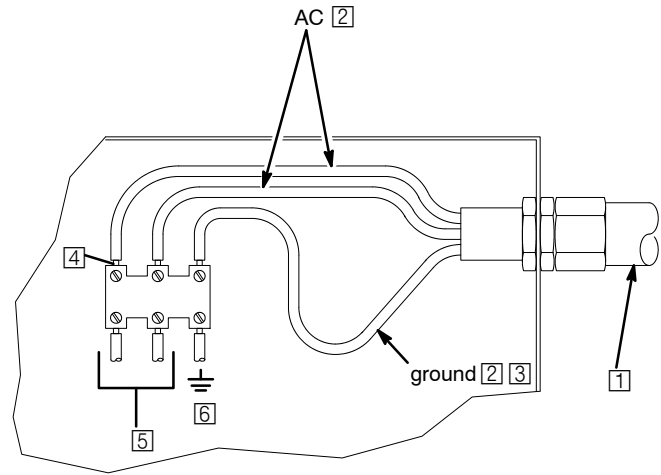

- 1 AC power supply, 110 VAC or 220 VAC
NOTE: 220 VAC operation requires modification of transformer connections inside control module. See page 11.
- 2 Power cable must be 12–22 AWG with a minimum of 6 in. (152 mm) of the wire jacket removed.
- 3 Leave ground wire 2 inches (50.8 mm) longer than the two AC wires. **NOTE:** Ground wire is green with yellow stripe.
- 4 Strip 0.25 in. (6.4 mm) of insulation from wires, insert wires into terminal block, and tighten screws to hold wire.
- 5 To transformer
- 6 To chassis ground

Fig. 5

06650

Cable Routing and Connection

7. Route the Solenoid and Meter Cables to their Assigned Control Module

8. Connect the Solenoid and Meter Cables

- f. Connect the solenoid cables as shown in Fig. 6. The cables connect at the solenoid end with wire nuts.
- g. Connect the Ready Light as shown in Fig. 6.
- h. Connect the pulse meter cables. The cables connect at the pulse meter end with wire nuts.
 - Connect an oil meter as shown in Fig. 7.
 - Connect an anti-freeze meter as shown in Fig. 8. Be sure to install the RC Filter.

Solenoid Connection

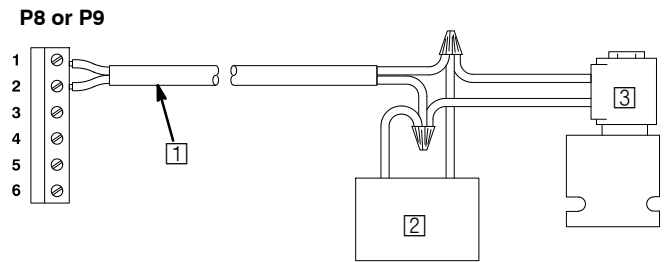

- 1 Use bulk Cable P/N 113557 (500 ft. [152.5 m]) or 113558 (1000 ft. [305 m]); 50 ft. (15.3 m) maximum length
- 2 Ready Light Kit 238996
NOTE: If existing Ready Light is used, the bulb and lens must be replaced with bulb P/N 113859 and lens 113857
- 3 Fluid Solenoid P/N 218588 (includes Ready Light), 215487 or 512927; Air Solenoid P/N 215407 or 512926

Fig. 6

06577

NOTE: See Fig. 9, page 16, for connector locations.

Pulse Meter P/N 238618 Connection

- 1 Connector J5 in this drawing; can be J5, J6, or J7
- 2 Use bulk Cable P/N 113555 (500 ft. [152.5 m]) or 113556 (1000 ft. [305 m]); 50 ft. (15.3 m) maximum length
- 3 Pulse Meter P/N 238618

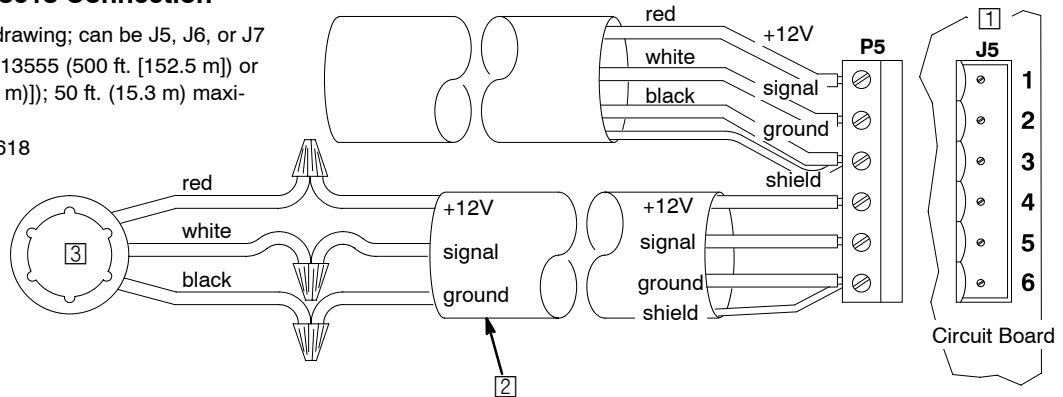

Fig. 7

06579

Pulse Meter P/N 215474 Connection

- 1 Connector J5 in this drawing; can be J5, J6, or J7
 - 2 RC Filter P/N 113837; included with meter
 - 3 Pulse Meter P/N 215474
- NC=No Connection

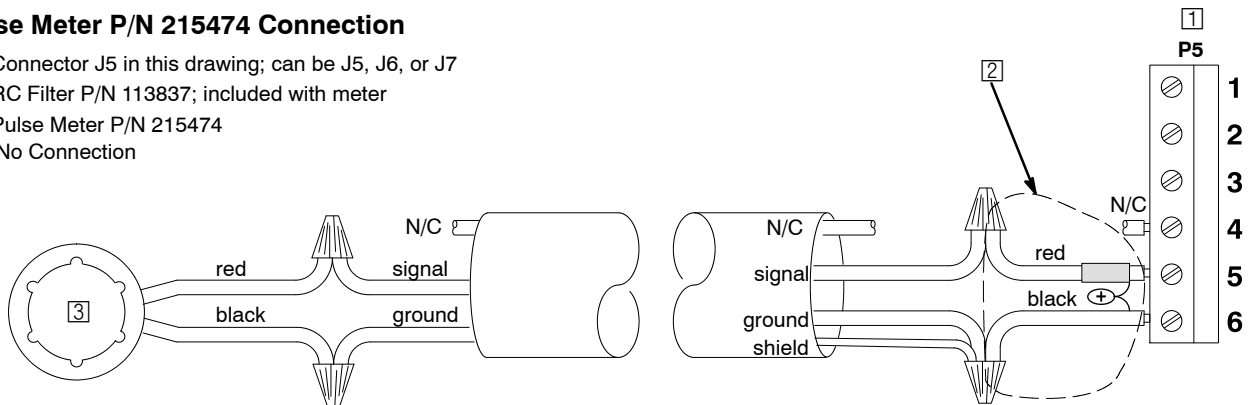

Fig. 8

06580

Cable Routing and Connection

9. Connect the Control Modules to the CAN (Controller Area Network)

WARNING

FIRE, EXPLOSION, AND ELECTRIC SHOCK HAZARD

To reduce the risk of fire, explosion, and electric shock all wiring must be done by a qualified electrician.

The cables are connected at each control module by stripping the wires and connecting the wires as shown in Fig. 10. Refer to Fig. 9 for the placement of the control module connectors.

Each control module ships with a terminating resistor on the connector for the CAN network. When the cable is connected to the control module, the resistor must be removed from the control modules located in the middle of the network chain, leaving only the resistors at each end of the network. The end resistors are necessary for the control modules to be able to communicate properly with each other across the network.

- Connect the control module(s) in the middle of the network chain as shown in Fig. 10, with the terminating resistor removed.
- Connect the control modules at the end of the network chain as shown in Fig. 10, with the terminating resistor in place.

Controller Area Network (4 control modules shown)

Use Bulk Cable P/N 113559 (500 ft. [152.5 m]) or 113560 (1000 ft. [305 m])

NOTE: No distance requirement between control modules provided the overall length of the network cables does not exceed 2000 ft. (610 m).

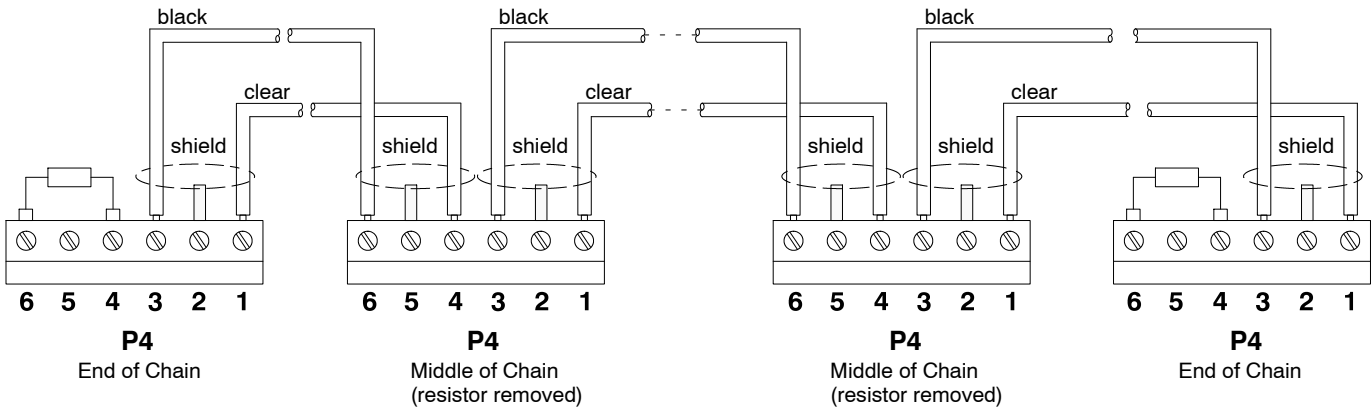

Fig. 10

06578

Control Module Connectors

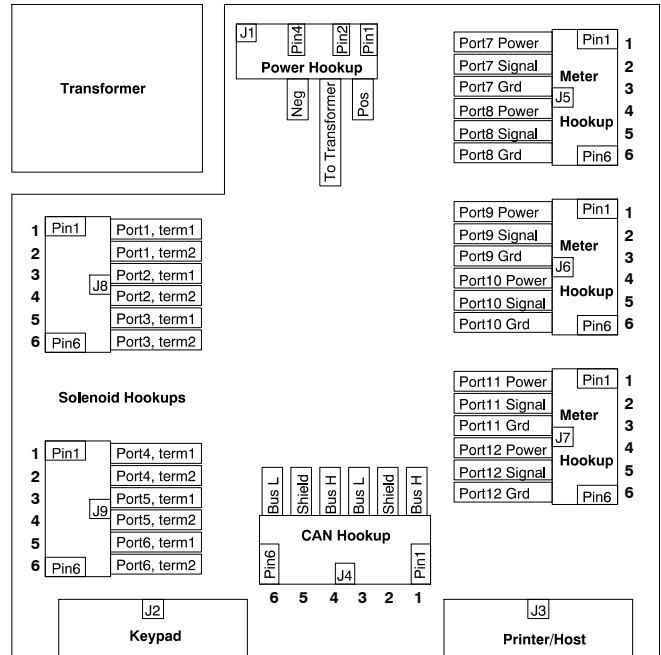

Fig. 9

06581

- Connect the shield at both ends of each cable section (pins 2 or 5).

Cable Routing and Connection

10. Connect the Keypad Cable

Route and connect the keypad cables (P/N 191393 (25 ft. [7.6 m]) or 191394 (50 ft. [15.3 m])) between the keypads and control module connectors. If using the Administrative or Enhanced Keypad, be sure to connect the cable to the top keypad connector. The bottom connector is for the bar code reader.

11. Connect the Printer or Computer Cable

Printer

New Style Printer: Program the DIP switches with the printer software. See instruction sheet 308818, included with the printer. Route and connect the printer cable between the printer and the Master Control Module connectors. Use the same cables that are used with the keypads. See Fig. 11.

Old Style Printer: Set the DIP switches on the bottom of the printer as shown in Fig. 12. Route and connect the printer cable between the printer and the Master Control Module connectors. Use the printer cables shown in Fig. 12.

Computer

Route and connect the computer cable (P/N 192873 (25 ft. [7.6 m]) or 192874 (50 ft. [15.3 m])) between the computer and the Master Control Module connectors. See Fig. 13.

See page 40 to set up your computer to receive Horizon system data.

12. Visually Check the Wire Connections

The Horizon hardware installation is now complete. The **Checklist** Steps 1 to 12, page 8, should be checked off.

Connecting to *New Style* Printer P/N 113774

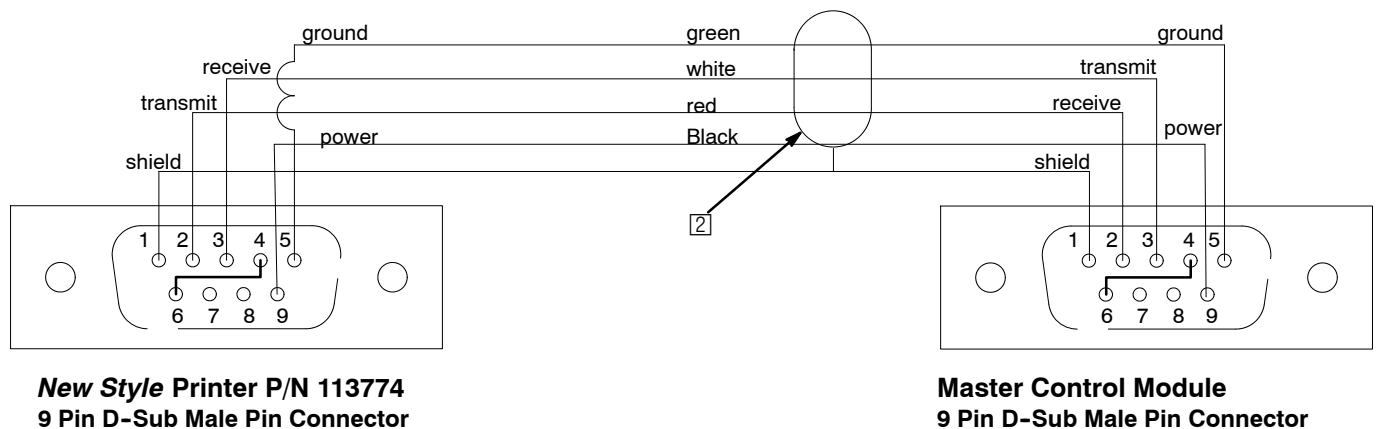

1 Printer cable with connector, P/N 191393 (25 ft. [7.6 m]) or 191394 (50 ft. [15.3 m])

Fig. 11

Cable Routing and Connection

Connecting to *Old Style Printer P/N 113774*

Standard DIP Switch Settings for *Old Style Printer 113774*

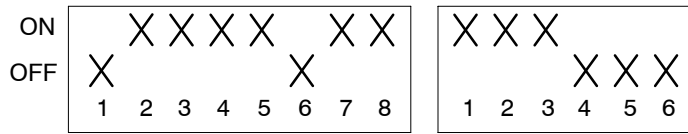

Communication Settings

- 9600 Baud Rate
- No Parity
- 1 Stop Bit
- 8 Data Bits
- No Software Handshaking

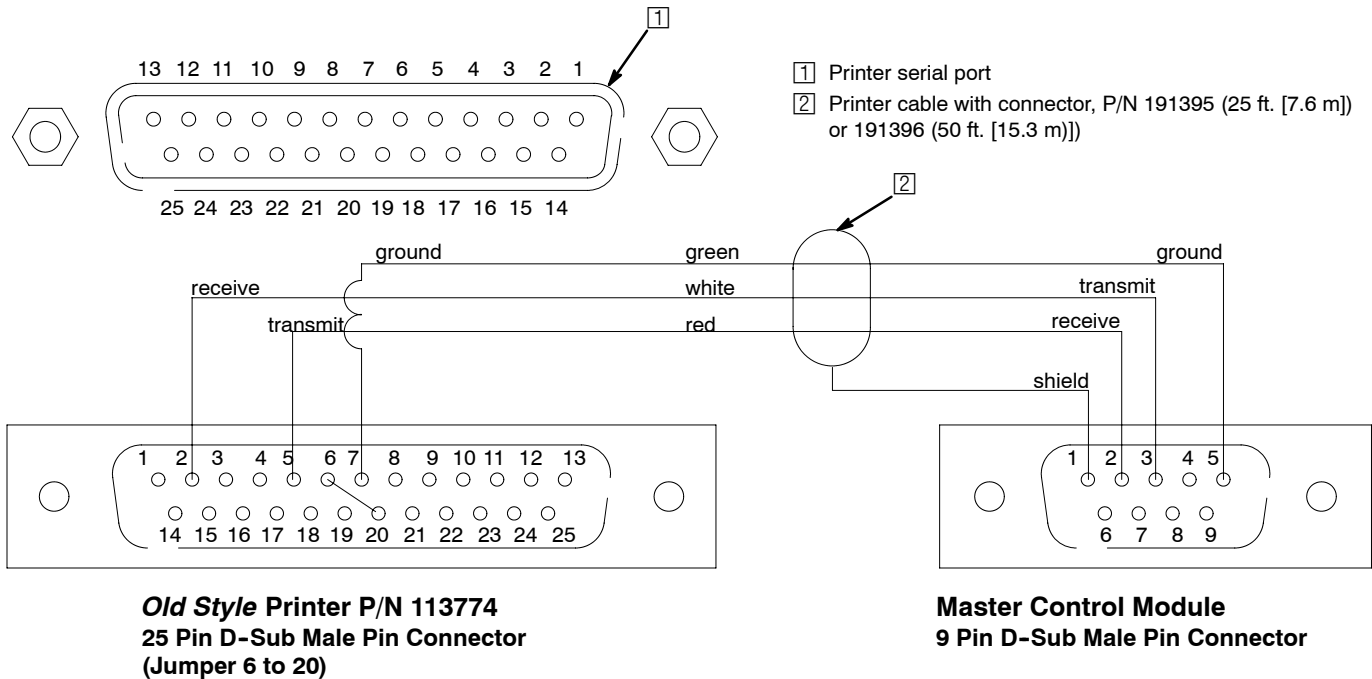
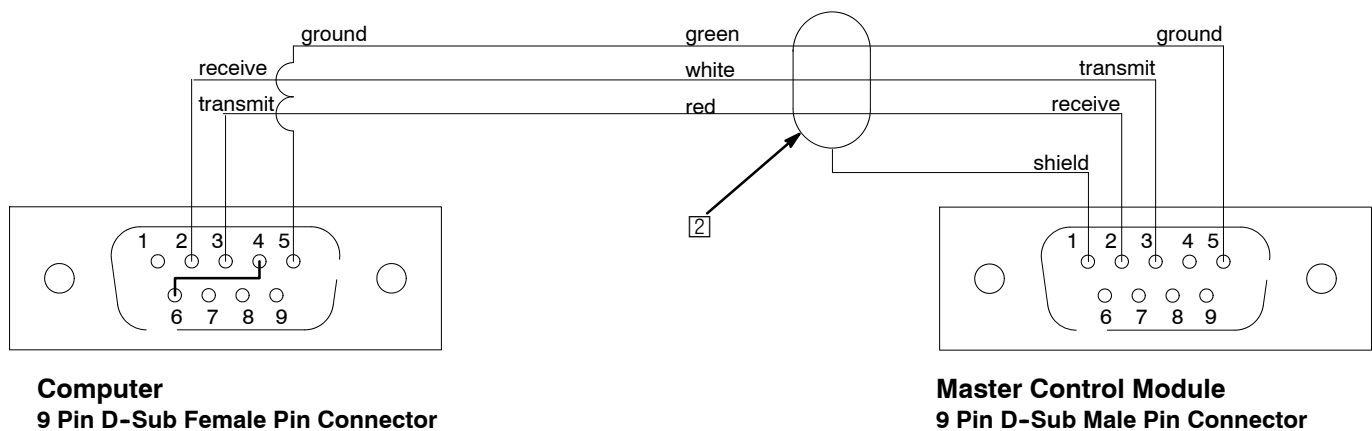

Fig. 12

Connecting to a Computer



- 1 Printer cable with connector, P/N 192873 (25 ft. [7.6 m]) or 192874 (50 ft. [15.3 m])

Fig. 13

System Setup - Startup

CAUTION

The addresses in the software must match the physical connections to the control modules or the system will not operate properly.

Instructions

Startup Screen

This screen is displayed for four seconds after the system is turned on, then the *Mode Selection* screen (or Home screen) appears.

Mode Selection (HOME)

This is the HOME screen. It is the destination any time the HOME button on the keypad is pressed.

1. Cursor is initially on RUN.
2. Move the cursor to SETUP by pressing the ↑ or ↓ key.

Enter Password

The password is determined by what is entered during setup. The first time the system is started, the Password is 1111.

1. Cursor is in the PASSWORD field.
2. Type the password.

Screens

STARTUP Screen

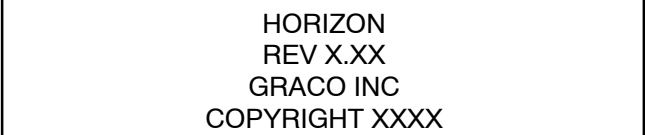

```
HORIZON
REV X.XX
GRACO INC
COPYRIGHT XXXX
```

NOTE: The SETUP option can only be modified on the administrator keypad.

3. Press ENTER on the keypad.

HOME Screen

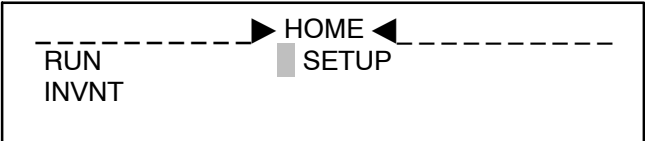

```
-----▶ HOME ◀-----
RUN          █ SETUP
INVNT
```

3. Press ENTER on the keypad.

PASSWORD Screen



```
ENTER PASSWORD
SETUP MENU
  █XXXX
```

System Setup - Startup

Instructions

Types of Setup

1. SETUP screen appears.
2. Cursor is on ENABLE/DISABLE CAN.
3. Move the cursor by pressing the ↑ or ↓ key.
4. Press ENTER on the keypad when the cursor is at the desired selection.

ENABLE/DISABLE CAN: ENABLE CAN is the default selection. It indicates that the system has more than one control module. For normal operation, all control modules should have CAN enabled. To change to DISABLE CAN, which must be done for a system with only one control module, follow page 21.

NOTE: When a controller's CAN communication is disabled, the controller will not send any CAN messages but it can still receive CAN messages.

MODIFY SETUP: to modify a current setup. See page 22.

NEW SETUP: to enter a completely new setup. See page 22.

CLEAR SETUP: to clear particular setup options. Choose CLEAR SETUP if this is the initial setup of a new system. See page 23.

PRINT SETUP: to print out selected information about the control module. If this is the initial setup of a new system, print out ALL MEMORY after the system is completely installed, for future reference. See page 24.

UPDATE TABLES: to send information from one control module to all connected control modules. If the Master Control Module was setup off-line, use this feature to send information to all control modules after they are connected. See page 25.

DIAGNOSTICS: to help troubleshoot the system. See page 26.

Screens

SETUP Screens

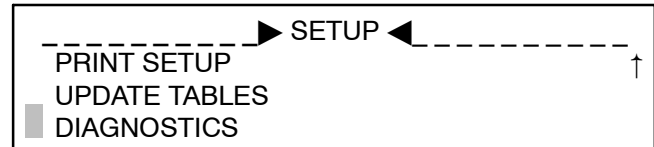
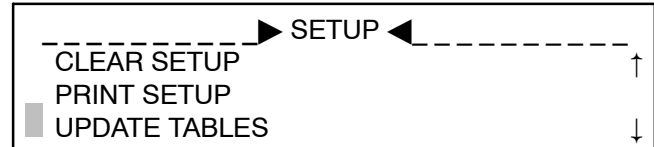
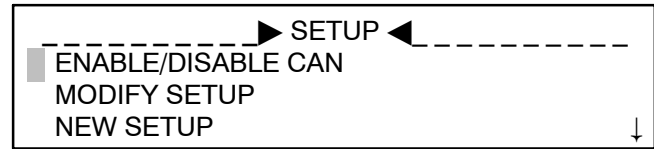

System Setup - Enable/Disable CAN

Instructions

Enable/Disable CAN Option

NOTE: See page 3 for CAN definition.

1. With the cursor at ENABLE/DISABLE CAN, press ENTER on the keypad.
2. The CAN COMMUNICATIONS screen will appear, with the cursor at ENABLE CAN.
3. Press the ↓ or ↑ key to toggle between ENABLE and DISABLE CAN. Change to DISABLE CAN if the system has only one control module or if programming the Master Control Module off the customer site.
4. Press ENTER on the keypad when the cursor is at the desired option.

5. The controller will return to the SETUP OPTIONS screen to allow another option to be selected and modified until HOME is pressed.

Screens

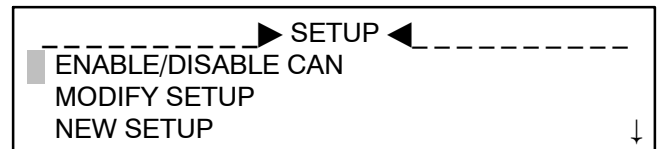

CAN Screen

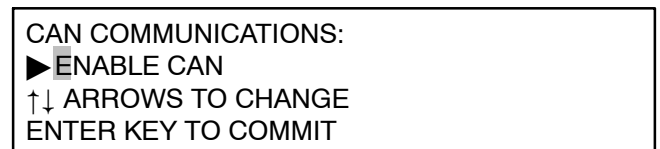

System Setup - Modify or New

Instructions

Modify Setup Options

1. With the cursor at MODIFY SETUP, press ENTER on the keypad.
2. The SETUP OPTIONS screen will appear. Only Master Control Module will have TIME AND DATE on the screen.
3. Scroll to the option that needs to be modified by pressing the ↓ or ↑ key.
4. Press ENTER on the keypad when the cursor is at the desired option.
5. Follow the instructions for modifying the selected option, starting on page 29.
6. Every time a setup option is modified and saved, the controller will return to the SETUP OPTIONS screen to allow another option to be selected and modified until HOME is pressed.

New Setup Options

NOTE: If you are installing a new system, use CLEAR SETUP→ALL MEMORY to prepare the system for setup. See page 39.

1. With the cursor at NEW SETUP, press ENTER on the keypad.
2. Follow the instructions for modifying the options, starting on page 29.
3. Every time a setup option is modified and saved, the controller will go directly to the first screen of the next setup subroutine.

Screens

The options that can be defined in MODIFY SETUP include:

- Time and date*
- Operator passwords
- Control modules
- Fluids
- Dispense areas
- Assign connections
- Meter calibration
- Inventory
- Comm. on CM #1
- Run options
- System time outs

* On Master Control Module only.

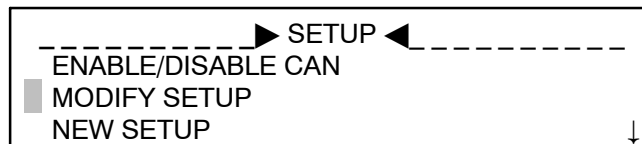

MODIFY SETUP Screen



The options that can be defined in NEW SETUP include:

- Time and date*
- Operator passwords
- Control modules
- Fluids
- Dispense areas
- Assign connections
- Meter calibration
- Inventory
- Comm. on CM #1
- Run options
- System time outs

* On Master Control Module only.

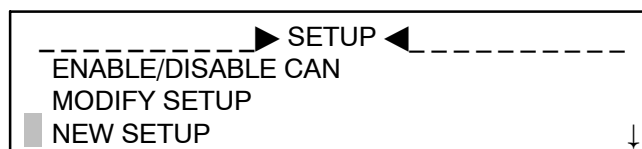

System Setup - Clear Setup

Instructions

Clear Setup Options

CAUTION

Clearing the OPERATOR PASSWORDS or ALL MEMORY will delete all passwords, including the password the system is supplied with, which allows Setup access. Before exiting SETUP, enter a new password for Setup access. See page 29.

Do not clear memory while there are active or waiting jobs in the system. Memory should only be cleared at installation time or before a new software setup configuration.

1. Move the cursor to CLEAR SETUP using the ↓ key.
2. Press ENTER on the keypad.
3. The CLEAR OPTIONS screen will appear, with the cursor at ALL MEMORY.
4. Scroll to the option that needs to be modified by pressing the ↓ or ↑ key.
5. Press ENTER on the keypad when the cursor is at the desired option.
6. The CLEAR verification screen will appear with the cursor on **NO**. If ENTER is pressed with NO selected, the screen will return to CLEAR OPTIONS screen.
7. Scroll to YES by pressing the ↓ or ↑ key.
8. Press ENTER on the keypad. The selected table will be cleared and the CLEAR OPTIONS screen will appear.
9. Press BACK key to return to SETUP screen.

The options that can be defined in CLEAR SETUP include:

- All memory
- Operator passwords
- Control modules
- Fluids and inventory
- Dispense areas
- Assign connections
- Meter calibration
- Comm. on CM #1
- Run options
- System time outs
- Queues
- Transactions (*on Master Control only*)

Screens

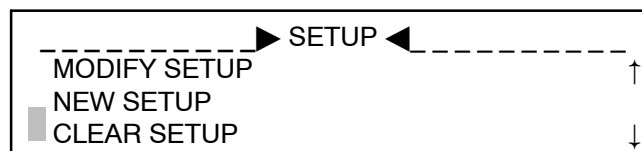

CLEAR OPTIONS Screen

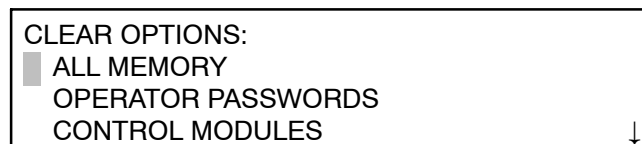

CLEAR VERIFICATION Screen

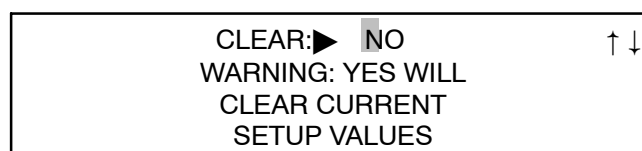

System Setup - Print Setup

Instructions

Print Setup Options

NOTE:

- Only the information for the control module the keypad is connected to is printed.
- Avoid printing setup while operating the system. Print setup when the system is inactive. If a job completes and the information is sent to the printer, the setup printing will be cancelled and the PRINTING OF SETUP INTERRUPTED screen will appear. Use VIEW CURRENT JOBS run menu (see page 54) to verify that the system is inactive.

1. Move the cursor to PRINT SETUP using the ↓ key.
2. Press ENTER on the keypad.
3. The PRINT OPTIONS screen will appear, with the cursor at ALL MEMORY.
4. Scroll to the selection that you want to print by pressing the ↓ or ↑ key.
5. Press ENTER on the keypad when the cursor is at the desired option. The PRINTING screen will appear. Press any key to exit after DONE appears on the screen.
6. Press BACK key to return to SETUP screen.

The information that can be printed in PRINT SETUP include:

- | | |
|------------------------|--|
| • All memory | • System time outs |
| • Operator passwords | • Active queue |
| • Control modules | • Waiting queue |
| • Fluids and inventory | • Local queue |
| • Dispense areas | • Transactions (<i>available on Master Control only</i>) |
| • Assign connections | • Memory map |
| • Meter calibration | • Table checksums |
| • Comm. on CM #1 | • Test |
| • Run options | |

NOTE: Printing ALL MEMORY is generally unnecessary and should be avoided as it will print the entire transaction table, which could be extremely long.

Screens

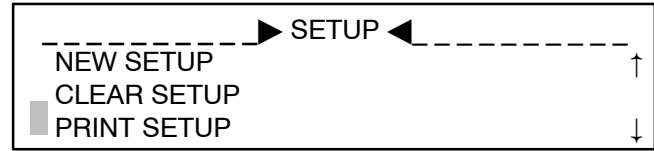

PRINT OPTIONS Screen



PRINTING Screen

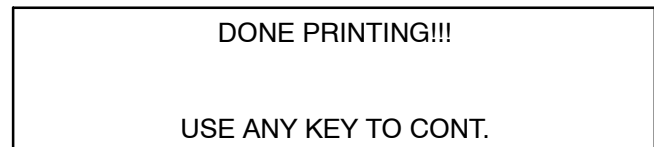
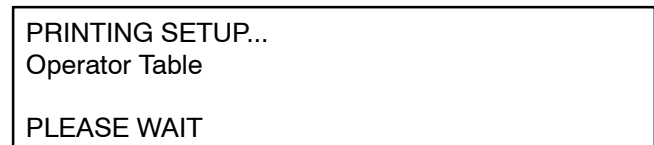

PRINTING OF SETUP INTERRUPTED Screen

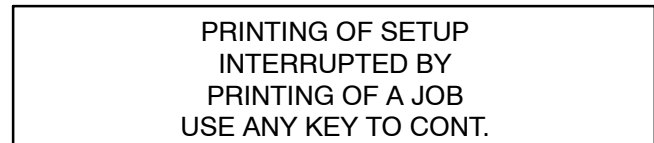

System Setup - Update Tables

Instructions

Update Tables Options

CAUTION

Do not update tables while there are active or waiting jobs in the system. **Whenever a table is updated, power down the system before it is used again so the software initiates the changes correctly.**

1. Move the cursor to UPDATE TABLES using the ↓ key.
2. Press ENTER on the keypad.
3. The UPDATE TABLES screen will appear, with the cursor at ALL TABLES.
4. Scroll to the option that needs to be modified by pressing the ↓ or ↑ key.
5. Press ENTER on the keypad when the cursor is at the desired option.
6. The UPDATE TABLE verification screen will appear with the cursor on **NO**. If ENTER is pressed with NO selected, the screen will return to UPDATE TABLES screen.
7. Scroll to YES by pressing the ↓ or ↑ key.
8. Press ENTER on the keypad. The selected table will be cleared and the UPDATING screen will appear. Press any key to return to the UPDATE TABLES screen.
9. Press BACK key to return to SETUP screen.

The options that can be defined in UPDATE TABLES include:

- All tables
- Operator passwords
- Control modules
- Fluids and inventory
- Dispense areas
- Assign connections
- Meter calibration
- Inventory
- Comm. on CM #1
- Run options
- System time outs
- Queues

Screens

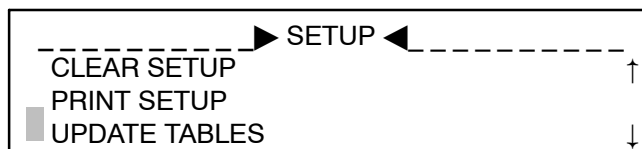

UPDATE TABLES Screen



UPDATE TABLES VERIFICATION Screen

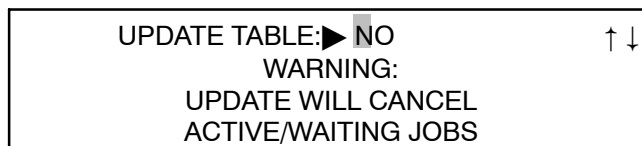

UPDATING Screen

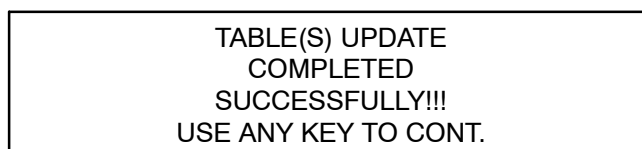
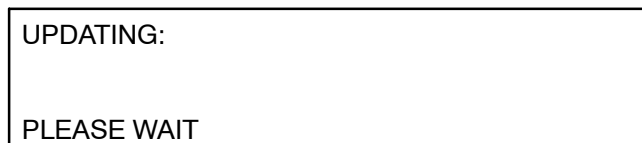

System Setup - Diagnostics

Instructions

Diagnostics

NOTE:

- The diagnostic information that appears on the keypad screen **refers to the control module the keypad is connected to only**, except when using the CAN diagnostics.
- Any fluids dispensed while doing diagnostics will not be tracked and will not be included in the system inventory information.

1. Move the cursor to DIAGNOSTICS using the ↓ key.
2. Press ENTER on the keypad.
3. The DIAGNOSTICS screen will appear, with the cursor at ABOUT.
4. Scroll to the option that you want to select by pressing the ↓ or ↑ key. Press ENTER to display that screen option.
5. The ABOUT screen will display information about the software. Pressing any key will return the cursor to the DIAGNOSTICS screen.
6. The POWER UP screen will tell how many times the board has been powered up since the last software upgrade. Pressing any key will return the cursor to the DIAGNOSTICS screen.
7. The SOLENOIDS screen allows you to check the operation of the solenoids by turning them off and on.

⚠ CAUTION

When activating solenoids, fluid may be dispensed.

You are only testing the solenoids that are connected to the control module the keypad is connected to.

LO indicates the solenoid is off. To turn it on, press the ↓ or ↑ key and LO will change to HI. Press ENTER to turn the solenoid on. The cursor will move to the next solenoid designation.

Scroll to LO and press ENTER to turn the solenoid(s) off again.

Continue to test the solenoids as needed.

Any solenoids that are turned on while using the SOLENOIDS screen should be turned off before exiting the screen.

Press the BACK key to go back to the DIAGNOSTICS screen.

Screens

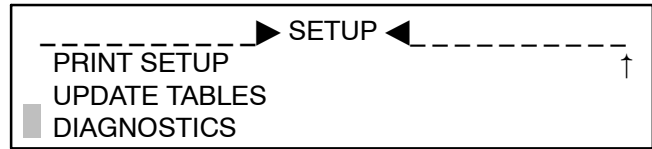

DIAGNOSTICS Screens

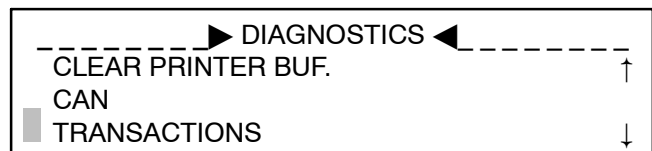
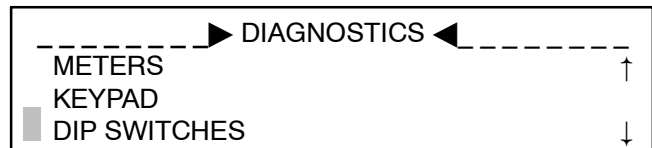
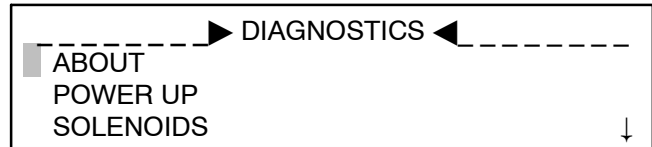

ABOUT Screen

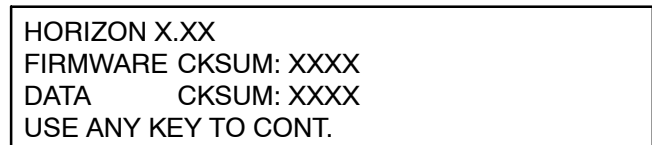

POWER UP Screen

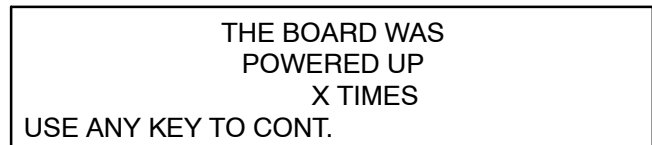

SOLENOIDS Screen

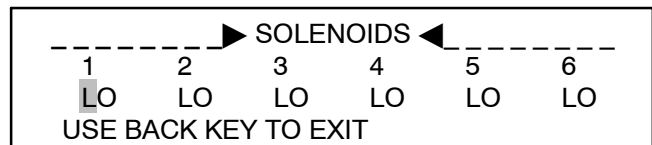

System Setup - Diagnostics

Instructions

Diagnostics (continued)

- The METERS screen appears with the cursor at the MONITOR METERS option. If that option is selected, a screen will appear that allows you to select meters to check.
- Scroll to the meter you want to check and press ENTER. A screen will appear that tells how many pulses the meter has read. Pressing any key will return the cursor to the METERS screen.

NOTE: The pulse count clears whenever the system is reset or turned off or the meter is cleared manually (ZERO METER COUNTERS), as explained below.

If ZERO METER COUNTERS is entered, a screen appears that allows you to select meters to clear. Clear (ZERO) the meters as needed.

Press BACK to return to the METERS screen.

- The KEYPAD screen appears with the cursor at the second line, which should show the type of keypad you are using right now. ADMIN/ ENHANCED or BASIC are the two choices.
- The DIP SWITCHES screen shows the dip switch setting for the control module the keypad is connected to (CM ID 1 in the screen example). Verify the unique ID of the controller.

NOTE: It is critical that the control module address (CM ID) match the number entered in the setup tables. If it does not match, the system will not function properly.

Screens

METERS Screens

```
-----▶ METERS ◀-----
| █ MONITOR METERS |
| ZERO METER COUNTERS |
```

Monitor Meters

```
SELECT METER NUMBER:
| █ MONITOR METER 7 |
| MONITOR METER 8 |
| MONITOR METER 9 | ↓
```

```
MONITORING METER 7:
X PULSES

USE ANY KEY TO CONT.
```

Zero Meter Counters

```
-----▶ METERS ◀-----
| █ MONITOR METERS |
| █ ZERO METER COUNTERS |
```

```
SELECT METER NUMBER:
| █ ZERO ALL METERS |
| ZERO METER 7 |
| ZERO METER 8 | ↓
```

```
METER X COUNTER
CLEARED.

USE ANY KEY TO CONT.
```

KEYPAD Screen

```
KEYPAD MODEL:
| █ ADMIN/ENHANCED | ↑↓
↑↓ ARROWS TO CHANGE
ENTER KEY TO COMMIT
```

DIP SWITCHES Screen

```
-----▶ DIP SWITCHES ◀-----
| 1 2 3 4 5 6 7 8 |
| 1 0 0 0 0 0 1 1 |
CM ID: 1
```

System Setup - Diagnostics

Instructions

Diagnostics (continued)

12. Entering CLEAR PRINTER BUF. will clear the printer buffer. **Only use this option with printer part no. 113774.**
13. The CAN screen has the following options:
 - CONTINUOUS CAN COMM: Not implemented in this software version.
 - MANUALLY TEST CAN: Use to test the CAN connections between control modules. If the MANUALLY TEST CAN option is selected, the TEST CAN screen will appear. The other control module keypad must also be at the TEST CAN screen. Type in a couple alpha numeric keys in the Xmit (transmit) field. If the network is transmitting properly, those characters should then appear in the other keypad's Rcv (receive) field. Press ENTER to clear the Xmit field of the TEST CAN screen.
 - CAN LEDs: Use to check the operation of the three LEDs located on the left side of the J2 connector in the control module. The LEDs can be turned off and on by toggling the Off/On selection on the CAN LEDs screen.
- Any LEDs that are turned on while using the CAN LEDs screen should be turned off before exiting the screen.
14. The TRANSACTIONS screen is only available on the Master Control Module and can be used to test the printer or computer connection. A confirmation screen will appear. If YES is selected, the transaction table fills with test data, which prints out in computer or printer format, depending on what was selected during setup. See page 37. See page 40 for information on computer output. The transaction table is then cleared and the system exits.

NOTE: The transaction report can include as many as 700 records. To stop the printing, take the printer off-line.

⚠ CAUTION

Selecting the transactions screen will clear all the previous transactions.

Screens

CLEAR PRINTER BUFFER Screen

```

-----▶ DIAGNOSTICS ◀-----
KEYPAD
DIP SWITCHES
█ CLEAR PRINTER BUF.
    
```

```

THE PRINTER BUFFER
WAS SUCCESSFULLY
CLEARED.
USE ANY KEY TO CONT.
    
```

CAN Screens

```

-----▶ CAN BUS ◀-----
CONTINUOUS CAN COMM
█ MANUALLY TEST CAN
CAN LEDs
    
```

MANUALLY TEST CAN

```

-----▶ TEST CAN ◀-----
Xmit: █
Rcv:
USE BACK KEY TO EXIT
    
```

CAN LEDs

```

-----▶ CAN BUS ◀-----
CONTINUOUS CAN COMM
MANUALLY TEST CAN
█ CAN LEDs
    
```

```

-----▶ CAN LEDs ◀-----
RED      YELLOW      GREEN
Off      Off        Off
USE BACK KEY TO EXIT
    
```

TRANSACTION Screens

```

PROCESS WILL OUTPUT
MANY JOB REPORTS
PROCEED: ↑▶ NO
USE ENTER TO CONT.
    
```

```

PRINTING TRANSACTION
TABLE ...
POSITION XXX
PLEASE WAIT
    
```

```

TRANSACTION TEST
SUCCESSFULLY
COMPLETED
USE ANY KEY TO CONT.
    
```

System Setup - Time and Date

Instructions

Set Time and Date

NOTE: Only the Master Control Module can access the TIME AND DATE screen.

1. With the cursor in the DATE field, type in the month, day, and year (MMDDYY).
2. Press ENTER on the keypad.
3. With the cursor in the TIME field, type in the hour and minute (HH:MM). Note that the Horizon has a 24 hour clock.
4. Press ENTER on the keypad.

Screens

```
-----▶ TIME & DATE ◀-----
DATE (MMDDYY) 050296
TIME (HH:MM) 15:50
```

```
-----▶ TIME & DATE ◀-----
DATE (MMDDYY) 050296
TIME (HH:MM) 15:50
```

System Setup - Operator Access

Instructions

Set Operator Access Information

1. With the cursor in the NAME field, type in the operators identification (maximum of 4 characters).
2. Press ENTER on the keypad.
3. With the cursor in the PASSWORD field, type in four letters and/or numbers for the operator's password.
4. Press ENTER on the keypad.
5. With the cursor in the ACCESS field, scroll to the correct access level using the ↓ or ↑ key. RUN, SETUP, or INVNT (inventory) can be entered.
 - Selecting RUN will allow the operator to use the Run Menu only.
 - Selecting INVNT will allow the operator to use the Run and Inventory Menu.
 - Selecting SETUP will allow the operator to use all of the system menus.
6. Press ENTER on the keypad.
7. With the cursor at ADD, press ENTER to add another operator. Or use the ↓ or ↑ key to scroll to DELETE and press ENTER to remove the entire record.

This sequence will repeat until EXIT is selected, then the SAVE SETUP screen will appear. See page 30.

Screens

```
NAME:
PASSWORD:
ACCESS:      RUN      ↓ or ↑
ADD          EXIT     DELETE
```

```
NAME:      JOE
PASSWORD:
ACCESS:      RUN      ↓ or ↑
ADD          EXIT     DELETE
```

```
NAME:      JOE
PASSWORD:  1234
ACCESS:      RUN      ↓ or ↑
ADD          EXIT     DELETE
```

```
NAME:      JOE
PASSWORD:  1234
ACCESS:      RUN      ↓ or ↑
ADD          EXIT     DELETE
```

Saving the Setup

Follow the **Save Setup** procedure on page 30.

System Setup - Save Setup

Instructions

Save Setup

CAUTION

Do not save any setup information while there are active or waiting jobs in the system. Active or waiting jobs will be canceled when you save setup. **Whenever a table is saved, power down the system before it is used again so the software initiates the changes correctly.**

NOTE: The Master Control Module will update the copied setup files in each Slave Control Module.

1. The SAVE SETUP verification screen will appear with the cursor on **NO**.
 - If modifying the setup, pressing ENTER with NO selected, will return to the SETUP OPTIONS screen without saving.
 - If entering a new setup, pressing ENTER with NO selected, will return to the MODIFY SETUP options screen without saving.
2. Scroll to YES by pressing the ↓ or ↑ key.
3. Press ENTER on the keypad to save the setup options.
4. A screen will appear to notify you that your save was successful. Press any key on the keypad to continue setup.

Screens

SAVE SETUP: ► NO ↑↓
WARNING:
SAVE WILL CANCEL
ACTIVE/WAITING JOBS

SAVE SETUP: ► YES ↑↓
WARNING:
SAVE WILL CANCEL
ACTIVE/WAITING JOBS

TABLE SAVED
SUCCESSFULLY !!!

USE ANY KEY TO CONT.

System Setup - Important!

In order for the system to operate properly, the following guidelines must be followed when entering the following setup information:

- Fill out the name fields completely.

- Complete the setup tables in the order they appear as information in consecutive screens is dependant on information entered in previous screens.

System Setup - Control Modules

Instructions

Name the Master Control Module

1. Cursor is in the NAME field.
2. Type the name of the control module location (maximum of 10 characters).
3. Press ENTER on the keypad.
4. Cursor moves to ADD.
5. Press ENTER to add another control module.

Name Slave Control Modules

1. Cursor is in the CM# field.
2. The control module number will automatically increment up by 1 as you add modules or you can type the number identification.
NOTE: The control module number must correspond with the numbers setup on the control module DIP switch.
3. Press ENTER on the keypad.
4. Cursor moves to the NAME field.
5. Type the name of the control module location.
6. Press ENTER on the keypad.
7. Cursor moves to ADD.
8. Press ENTER to add another control module.
 - Or move the cursor to DELETE to delete the control module entry that is displayed.
 - Or move the cursor to EXIT to exit the control module setup.

Save the Setup

Follow the **Save Setup** procedure on page 30.

Screens

```
NAME CONTROL MODULES
  CM#01 (MASTER CM)
NAME: █ _____
  ADD      EXIT
```

```
NAME CONTROL MODULES
  CM#02 (SLAVE CM)
NAME: █ _____
  ADD      EXIT  DELETE
```

```
NAME CONTROL MODULES
  CM#02 (SLAVE CM)
NAME: █ _____
  ADD      EXIT  DELETE
```

System Setup - Fluids

Instructions

Enter Fluid Data

1. Cursor is in the fluid number (FL01) field.
2. The fluid number will automatically increment up by 1 as you add fluids or you can type the number identification of the fluid.
3. Press ENTER on the keypad.
4. Cursor moves to the NAME field.
5. Type the name of the fluid.
6. Press ENTER on the keypad.
7. Cursor moves to the UNITS field.
8. Scroll through the available units of measurement by pressing the ↓ or ↑ key, and stop at the value needed.

There are four units of measurement available: quarts, liters, gallons, and pints.
9. Press ENTER on the keypad.
10. Cursor moves to ORDER number field. The order number determines the order that fluids are displayed during RUN operations. The default setting is to display the fluids in the order of the fluid numbers.
11. Type in the order number if it is different than the number displayed.
12. Press ENTER on the keypad.
13. Cursor moves to ADD.
14. Press ENTER to repeat the screen and add another fluid.
 - Or move the cursor to DELETE to delete the fluid entry that is displayed.
 - Or move the cursor to EXIT to exit the fluid setup.

Save the Setup

Follow the **Save Setup** procedure on page 30.

Screens

FLO1 NAME: _____	
UNITS: QUARTS	↓ ↑
ORDER: 01	
ADD	EXIT DELETE

FLO1 NAME: _____	
UNITS: QUARTS	↓ ↑
ORDER: 01	
ADD	EXIT DELETE

FLO1 NAME: 10W30	
UNITS: QUARTS	↓ ↑
ORDER: 01	
ADD	EXIT DELETE

FLO1 NAME: 10W30	
UNITS: QUARTS	↓ ↑
ORDER: 01	
ADD	EXIT DELETE

FLO1 NAME: 10W30	
UNITS: QUARTS	↓ ↑
ORDER: 01	
ADD	EXIT DELETE

System Setup - Dispense Areas

Instructions

Define Dispense Areas

1. Cursor is in the dispense area number (DA01) field.
2. The dispense area number will automatically increment up by 1 as you add areas or you can type the number identification of the area.
3. Press ENTER on the keypad.
4. Cursor moves to the NAME field.
5. Type the name of the dispense area.
6. Press ENTER on the keypad.
7. Cursor moves to the first N in line three.
The fluid numbers will be displayed according to the number of fluids that were entered while **Entering the Fluid Data** (shown on previous page). In this example, 6 fluids were entered.
8. Leave the N if fluid #1 is not available at this dispense area. Scroll to Y by pressing the ↓ or ↑ key if the fluid is available at this dispense area.
9. Press ENTER on the keypad to ENTER the value and move to the next N.
10. Repeat step 8 and 9 until all the Y/N values are entered and the cursor moves to ADD.
11. Press ENTER to repeat the screen and add another dispense area.
 - Or move the cursor to DELETE to delete the dispense area that is displayed.
 - Or move the cursor to EXIT to exit the dispense area setup.

Save the Setup

Follow the **Save Setup** procedure on page 30.

Screens

DAO1 NAME: _____						
1	2	3	4	5	6	
N	N	N	N	N	N	
ADD			EXIT		DELETE	

DAO1 NAME: _____						
1	2	3	4	5	6	
N	N	N	N	N	N	
ADD			EXIT		DELETE	

DAO1 NAME: BAY 1						
1	2	3	4	5	6	
N	N	N	N	N	N	
ADD			EXIT		DELETE	

DAO1 NAME: BAY 1						
1	2	3	4	5	6	
Y	Y	Y	N	N	Y	
ADD	EXIT		DELETE			

System Setup - Connection Assignments

Instructions

Assign Connections

1. The dispense area and fluid number appear in the first row.
The combined designation of the dispense area and fluid number is called the *dispense point*.
2. Cursor is in the AIR SOL: CM field.
3. Type the number of the control module that controls the air solenoid for this dispense point.
NOTE: The air solenoid can be assigned a value of zero (PORT0) if an air solenoid is not used for this fluid, and the CM01 field can be left unchanged.
4. Press ENTER on the keypad.
5. Cursor moves to the PORT field.
6. Type the port number (1-6 or 0 if disabled)
7. Press ENTER on the keypad.
8. Cursor moves to the FLD SOL: CM field.
9. Type the number of the control module that controls the fluid solenoid for this dispense point.
10. Press ENTER on the keypad.
11. Cursor moves to the PORT field.
12. Type the port number (1-6).
13. Press ENTER on the keypad.
14. Cursor moves to the MTR# field.
15. Type the number of the meter for this dispense point. Assign the meters consecutive numbers, starting with number 1. The meters you enter will display when calibrating the meter, in the order they were entered.
16. Press ENTER on the keypad.
17. When the cursor is at MORE, press ENTER to repeat the screen for each valid dispense point.
- Or move the cursor to EXIT to exit the connection assignment setup.

Save the Setup

Follow the **Save Setup** procedure on page 30.

Screens

```
ASSGN CONN: DA01 FL01
AIR SOL: CM 01  PORT0
FLD SOL: CM 01  PORT0
MTR#: 000  MORE  EXIT
```

```
ASSGN CONN: DA01 FL01
AIR SOL: CM 01  PORT0
FLD SOL: CM 01  PORT0
MTR#: 000  MORE  EXIT
```

```
ASSGN CONN: DA01 FL01
AIR SOL: CM 01  PORT1
FLD SOL: CM 01  PORT0
MTR#: 000  MORE  EXIT
```

```
ASSGN CONN: DA01 FL01
AIR SOL: CM 01  PORT1
FLD SOL: CM 01  PORT0
MTR#: 000  MORE  EXIT
```

```
ASSGN CONN: DA01 FL01
AIR SOL: CM 01  PORT1
FLD SOL: CM 01  PORT1
MTR#: 000  MORE  EXIT
```

```
ASSGN CONN: DA01 FL01
AIR SOL: CM 01  PORT4
FLD SOL: CM 01  PORT1
MTR#: 000  MORE  EXIT
```

```
ASSGN CONN: DA01 FL01
AIR SOL: CM 01  PORT1
FLD SOL: CM 01  PORT1
MTR#: 001  MORE  EXIT
```

System Setup - Meter Calibration

Instructions

Screens

Set Meter Calibration

1. Cursor is in the METER NUMBER field.
2. The meter number will display according to the order they were entered while assigning connections (page 34).
3. Press ENTER on the keypad.
4. Cursor moves to the CM# field.
5. Type the number of the control module that controls the meter for this dispense point.
6. Press ENTER on the keypad.
7. Cursor moves to the PORT# field.
8. Type the number of the port the meter is connected to (7-12).
9. Press ENTER on the keypad.
10. Cursor moves to the PULSES PER XX field.
11. Type the number of pulses (per unit of measure).
 - Only integers between 1 and 9999 will be accepted for the calibration factor.
 - P/N 238618 Oil Meter has a nominal calibration factor of 200 pulses per quart (211 pulses per liter).
 - P/N 215474 Meter (for antifreeze and washer fluid) has a nominal factor of 10 pulses per quart (11 pulses per liter).
 - Start with the nominal value and adjust the value as needed to increase accuracy.
12. Press ENTER on the keypad.
13. When the cursor is at MORE, press ENTER to repeat the screen for each meter.
 - Or move the cursor to EXIT to exit the connection assignment setup.

Save the Setup

Follow the **Save Setup** procedure on page 30.

```
METER NUMBER: 001
CM# 01          PORT# 07
0001 PULSES PER QT
MORE          EXIT
```

```
METER NUMBER: 001
CM# 01          PORT# 07
0001 PULSES PER QT
MORE          EXIT
```

```
METER NUMBER: 001
CM# 01          PORT# 07
0001 PULSES PER QT
MORE          EXIT
```

```
METER NUMBER: 001
CM# 01          PORT# 07
0001 PULSES PER QT
MORE          EXIT
```

```
METER NUMBER: 001
CM# 01          PORT# 6
0200 PULSES PER QT
MORE          EXIT
```

System Setup - Inventory

Instructions

Screens

Set Inventory Levels

If inventory tracking is disabled (default setting):

- Can initiate any new jobs with preset or free flow.
- Tank levels under INVNT menu will not count down.
- Resettable/non-resettable totals will count up.
- The tank level is not checked against the preset amount.
- Inventory alarms will not display in the HOME screen.

If inventory tracking is enabled:

- All system fluids must be tracked.
- Tank levels under INVNT menu will count down.
- Resettable/non-resettable totals will count up.
- At the beginning of a job, the tank level is checked against the preset amount. If the preset amount exceeds the the amount of fluid in the tank, the job will not start.
- Inventory alarms will display on the last line of the HOME screen on each keypad, as shown in the **Inventory Alarm Screen Display** example below. Adding the fluid called for and updating the inventory tank level will clear the alarm. See page 57.

To Enable Inventory Tracking:

1. Cursor is in the ENABLE/DISABLE field. DISABLE is the default setting. Press the ↓ or ↑ key to scroll to ENABLE.
2. Press ENTER to confirm the setting and go to the next screen.
3. Cursor is in the fluid number (FL#01) field.
4. The fluid number will automatically increment up by 1, based on the fluids entered while entering the fluid data (page 32).
5. Press ENTER on the keypad.
6. Cursor moves to the REORDER PT. (point) field.
7. Type the minimum fluid level the tank should be allowed to reach before receiving an alarm to refill it.
8. Press ENTER on the keypad.
9. Cursor moves to the TANK LVL (level) field.
10. Type the current fluid level of the tank.
11. Press ENTER on the keypad.
12. When the cursor is at MORE, press ENTER to repeat the screen for each fluid.
- Or move the cursor to EXIT to exit the inventory levels setup.

```
INVENTORY TRACKING:
▶ DISABLE
↑↓ ARROWS TO CHANGE
ENTER KEY TO COMMIT
```

```
FL#01 10W30
00010 GL REORDER PT.
00100.0 GL TANK LVL
      MORE   EXIT
```

```
FL#01 10W30
00010 GL REORDER PT.
00100.0 GL TANK LVL
      MORE   EXIT
```

```
FL#01 10W30
00010 GL REORDER PT.
00100.0 GL TANK LVL
      MORE   EXIT
```

```
FL#01 10W30
00010 GL REORDER PT.
00100.0 GL TANK LVL
      MORE   EXIT
```

Inventory Alarm Screen Display

```
-----▶ HOME ◀-----
RUN
INVNT
LOW FL01
```

System Setup - Inventory

Instructions

To Disable Inventory Tracking:

1. Cursor is in the ENABLE/DISABLE field.
2. Press the ↓ or ↑ key to scroll to DISABLE and press ENTER to confirm the setting and go to the SAVE SETUP screen.

Save the Setup

Follow the **Save Setup** procedure on page 30.

Screens

INVENTORY TRACKING:

▶ **DISABLE**

↑↓ ARROWS TO CHANGE

ENTER KEY TO COMMIT

System Setup - Comm. on CM #1

Instructions

Set Master (#1) Control Module Output

The printing format selected here will be used to output all printing.

PRINTER output is formatted in a column that can be sent to either a printer or a computer.

COMPUTER output is a text file that can be used to create reports with a computer and additional software (such as Excel®).

See page 40 for further information and examples of output.

1. Cursor is in the field to select the source of the report output. PRINTER is the default setting.
2. To scroll to COMPUTER (HOST), press the ↓ or ↑ key.
3. Press ENTER to confirm the setting and go to the SAVE SETUP screen.

Save the Setup

Follow the **Save Setup** procedure on page 30.

Screens

▶ -----▶ MASTER OUTPUT ◀-----

▶ **PRINTER**

↑↓ ARROWS TO CHANGE

ENTER KEY TO COMMIT

▶ -----▶ MASTER OUTPUT ◀-----

▶ **COMPUTER (HOST)**

↑↓ ARROWS TO CHANGE

ENTER KEY TO COMMIT

System Setup - Run Options

Instructions

Set Run Options

1. Cursor is on **YES** in the PASSWORD? field in the RUN OPTIONS screen.
2. If it is desired to require the operator to enter a password, press ENTER with the cursor on YES.
3. Scroll to NO by pressing the ↓ or ↑ key.
4. If you do not want to require the operator to enter a password, press ENTER with the cursor on NO.
5. Continue to set either YES or NO in the JOB NUMBER, VEHICLE ID, REQUEST PRESET, AND CUSTOM INPUT fields.
6. If YES is selected for CUSTOM INPUT, the cursor will move to the NAME field. Type in the name of the additional information you want the operator to enter, for example, MILEAGE. Can enter up to 10 characters.

Save the Setup

Follow the **Save Setup** procedure on page 30.

Screens

RUN OPTIONS:	
PASSWORD?	<input checked="" type="checkbox"/> YES
JOB NUMBER?	YES
VEHICLE ID?	YES

RUN OPTIONS:	
REQUEST PRESET?	<input checked="" type="checkbox"/> YES
CUSTOM INPUT?	YES
NAME:	_____

System Setup - System Time-outs

Instructions

Set System Time-outs

Unused Keypad Time-out

If enabled, the keypad time-out helps avoid having an unauthorized person use an unattended keypad. An unused keypad will automatically return to the HOME screen after the set time elapses when it is in the run or inventory modes, requiring that a valid password be entered before re-accessing the run or inventory screens.

The time-out set for the keypad applies to all keypads connected to the system. If the time is left at 00, the keypad time-out feature is disabled.

1. Cursor is in MINUTES field.

Dispense Time-out

NOTE: Dispense time-out cannot be set to zero; it is always enabled. The time-out that is set will apply to the entire system.

Dispense time-out provides a way to close a job once it becomes active or waiting

The time set for dispense time-out represents the amount of time the operator has to start dispensing the job after it has been entered into the system. If there are no meter pulses within the set amount of time, the system will close the job.

The set time represents the amount of time the operator has to start dispensing the job after it has been entered into the system. If there are no meter pulses within the set amount of time, the system will close the job.

1. Cursor is in MINUTES field.

Save the Setup

Follow the **Save Setup** procedure on page 30.

2. Type the number of minutes you want to elapse before the time-out will occur.
3. Press ENTER to confirm the setting and go to the Dispense Time-out screen.

Screens

UNUSED KEYPAD WILL
RETURN TO HOME
AFTER 00 MINUTES.
USE ENTER TO CONT.

2. Type the number of minutes you want to elapse before the time-out will occur.
3. Press ENTER to confirm the setting and go to the SAVE SETUP screen.

01 MINUTES TO START
DISPENSE AFTER ENTRY
OR CLOSE JOB AFTER
LAST METER PULSE

Printer and Computer Output

Printer Output Format as Viewed on a Computer Screen

Job Report

Terminal - HORIZON.TRM
File Edit Settings Phone Transfers Help

12-15-1997 10:42:21
OPERATOR: RBM
FLUID: 01 5/30 OIL
DISPENSE AREA: 02 SUCE BAY
AMOUNT: 004.2 QT
JOB #: 3241578 VEHICLE ID: VEH3142
MILES: 0023146

12-15-1997 10:44:47
OPERATOR: BOBH
FLUID: 03 ATF
DISPENSE AREA: 03 GENSUCE 2
AMOUNT: 002.4 QT
JOB #: 3241568 VEHICLE ID: VEH3142
MILES: 0074221

Inventory Report

Terminal - HORIZON.TRM
File Edit Settings Phone Transfers Help

INVENTORY REPORT

FLUID 01 5/30 OIL 01492.3 GL IN TANK
FLUID 02 10/40 OIL 00992.7 GL IN TANK
FLUID 03 ATF 00996.2 GL IN TANK
FLUID 04 WWFL 00000.0 LT IN TANK

Printer and Computer Output

Computer [Host] Output Format

NOTE: The Master Output should be set to COMPUTER. See page 37. Set up the computer to receive Horizon data as instructed on page 43.

The Horizon can capture information about the dispense job and vehicle being serviced and download these records to a computer for further processing. This data can be used along with a spreadsheet software program (such as Excel) or other types of programs to generate reports, such as billing reports and preventative maintenance records.

Graco does not offer the software to create such reports. The following screens provide you with the layout of the text file Horizon produces. The user will need to have the expertise to use it with existing software or consult with a vendor to modify their software to use Horizon data.

NOTE: These records will always be the same length and the data fields will start in the same location. Spaces are transmitted for unused characters in a field.

Job Report

The screenshot shows a terminal window titled "Terminal - HORIZON.TRM" with a menu bar (File, Edit, Settings, Phone, Transfers, Help) and a list of job reports. Each line of the report is annotated with brackets and lines pointing to descriptive text below. The annotations identify the following fields:

- E:** Indicates "end of job report". J would indicate a report of past jobs.
- Date:** (mmddyyyy format)
- Time:** (hhmmss format, 24 hour clock)
- Operator Name**
- Fluid Number**
- Fluid Name:** (10 characters, includes spaces)
- Dispense Area Number**
- Dispense Are Name:** (10 characters, includes spaces)
- Amount Dispensed**
- Units of Dispense**
- Job Number:** (7 characters)
- Vehicle ID:** (7 characters)
- Optional Data Field:** (7 characters)
- Checksum:** (computer can use to validate transmission)

The job report data shown in the terminal is as follows:

```

E12151997102843TOMG015/30 OIL 01FAST LUBE 002.2QT1234567VEH543200333330FC7
E12151997102942TOMG0210/40 OIL 02SUCE BAY 004.4QT4231578VEH812300213450FB3
E12151997103409DANR03ATF 01FAST LUBE 003.3QT2323232VEH222200317620F5B
E12151997103510DANR0210/40 OIL 03GENSUCE 2 004.4QT6123478VEH312600231460FAA
E12151997103611RBW 0210/40 OIL 03GENSUCE 2 005.1QT3124666VEH432100225430F8B
E12151997103659B0BH03ATF 02SUCE BAY 004.1QT3241578VEH418700142370F46
  
```

Inventory Report

Terminal - HORIZON.TRM

File Edit Settings Phone Transfers Help

I 01 01492.3GL 029e

I 02 00992.7GL 02a7

I 03 00996.2GL 02a7

I 04 00000.0LT 029b

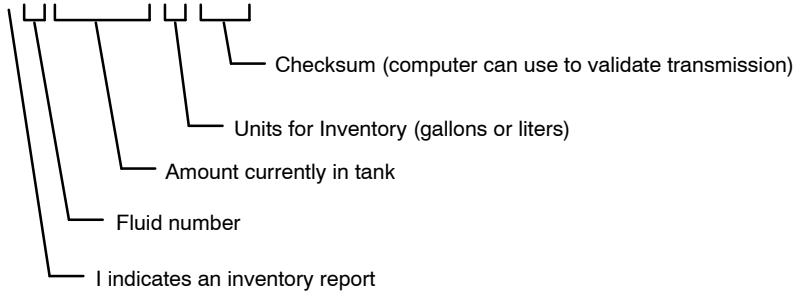

Computer: Receiving Horizon Data

Windows 3.1

The following instructions are for use with computers running Windows 3.1.

Terminal Program Setup

Follow these steps to provide the terminal program with the settings needed to receive Horizon data. Once these settings are saved, they do not have to be set and saved again, just load the HORIZON.TRM file each time the terminal program is started up.

1. Open **Accessories** in your **Program Manager**.
2. Open **Terminal**.



3. Pull down the **Settings** menu and select **Communications**.

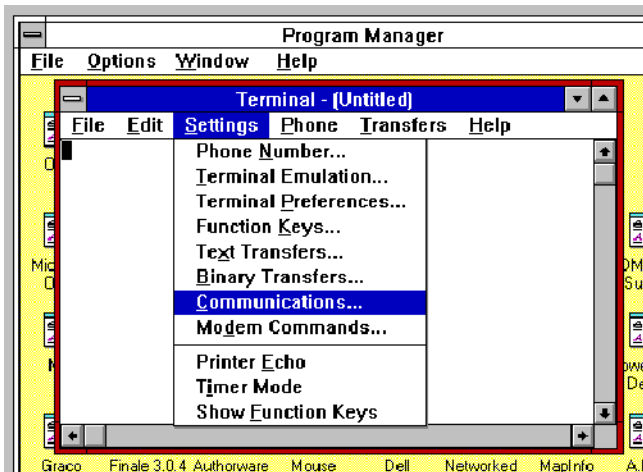

4. Set as shown below (Baud Rate-9600, Data Bits-8, Stop Bits-1, Parity-None, Flow Control-None, Connector-COM1), then select **OK**.

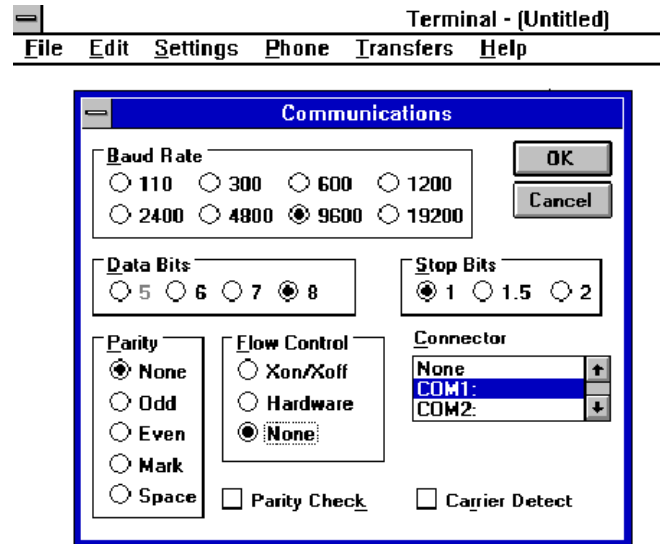

5. Pull down the terminal **File** menu and select **Save As**.
6. Type in the desired **File Name** (example: HORIZON.TRM).
7. Make sure the **Save Files of Type** is set to **Terminal Files (*.TRM)**.
8. Select the desired **Drive** and **Directory** where you want the Horizon terminal definition to be saved.
9. Select **OK**.

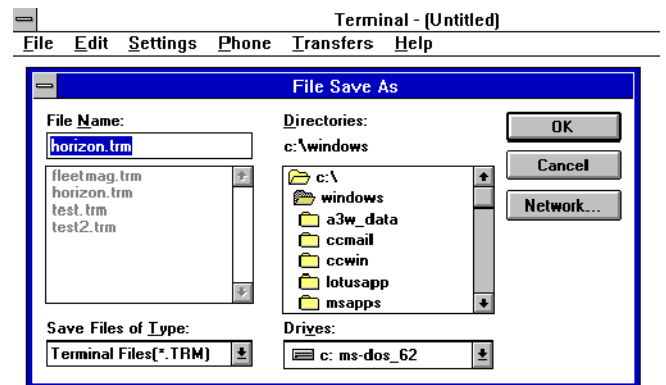

Computer: Receiving Horizon Data

Windows 3.1

Saving Horizon Job Records to the Computer

Follow these steps to save the Horizon job records to the computer disk. You can save the job records to files with each day's date (for example: 11-19-97.TXT). If the job records are not saved, they will scroll off the terminal program screen and the information will be lost.

1. When you want to save data from the Horizon system to the computer disk, pull down the terminal **Transfers** menu and select **Receive Text File**.

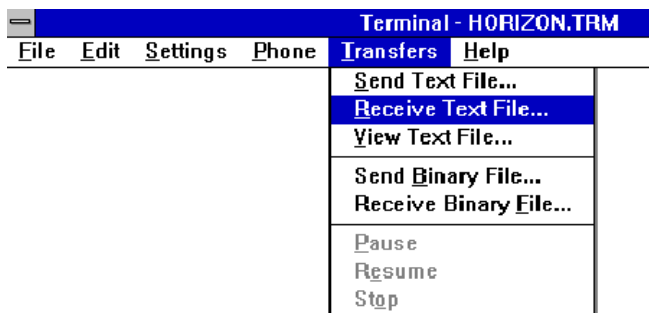

2. Type in the desired **File Name**.
3. Make sure the **Save Files of Type** is set to **Text Files (*.TXT)**.
4. Select the desired **Drive** and **Directory** where you want the Horizon data to be saved.
5. Select **OK**.

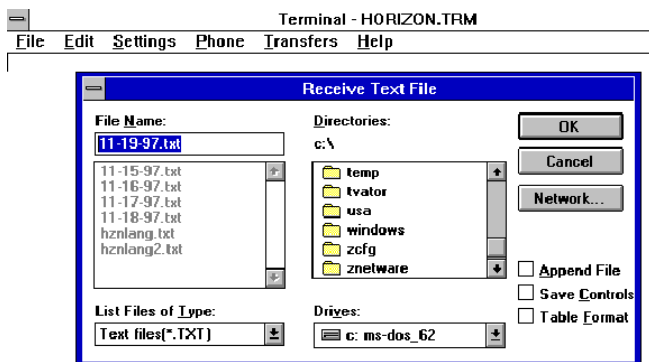

Windows 95

The following instructions are for use with computers running Windows 95.

Terminal Program Setup

Follow these steps to provide the terminal program with the settings needed to receive Horizon data. Once these settings are saved, they do not have to be set and saved again, just load the HORIZON.TRM file each time the terminal program is started up.

1. On your **Start** menu, select **Programs** ► **Accessories** ► **HyperTerminal**.

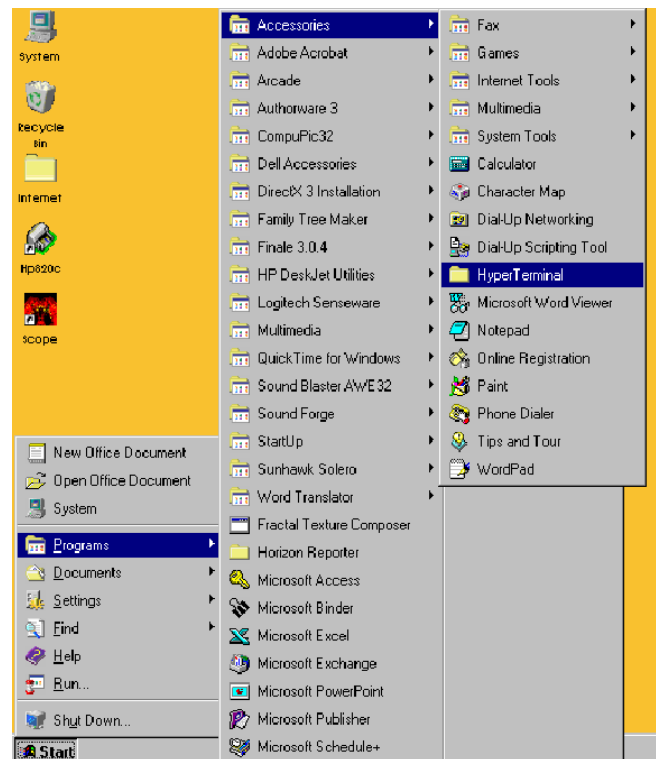

2. Open **Hypertrm.exe**.

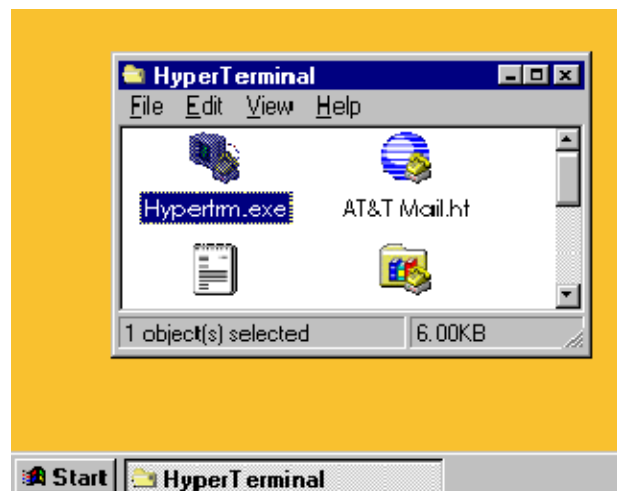

Computer: Receiving Horizon Data

3. Enter a **Name**, select an **Icon**, and select **OK**.

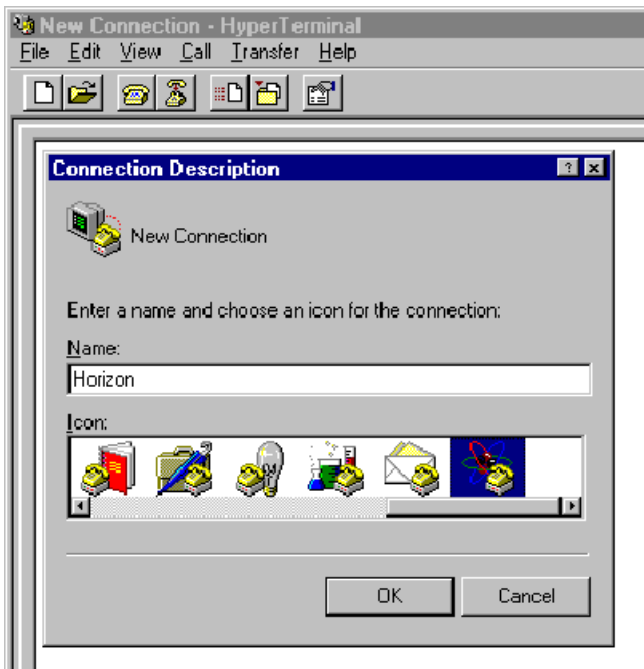

4. A screen for the HyperTerminal you just created will appear. It will take you through each setup screen.

5. Pull down the menu for **Connect using** and select **Direct to Com 1**.

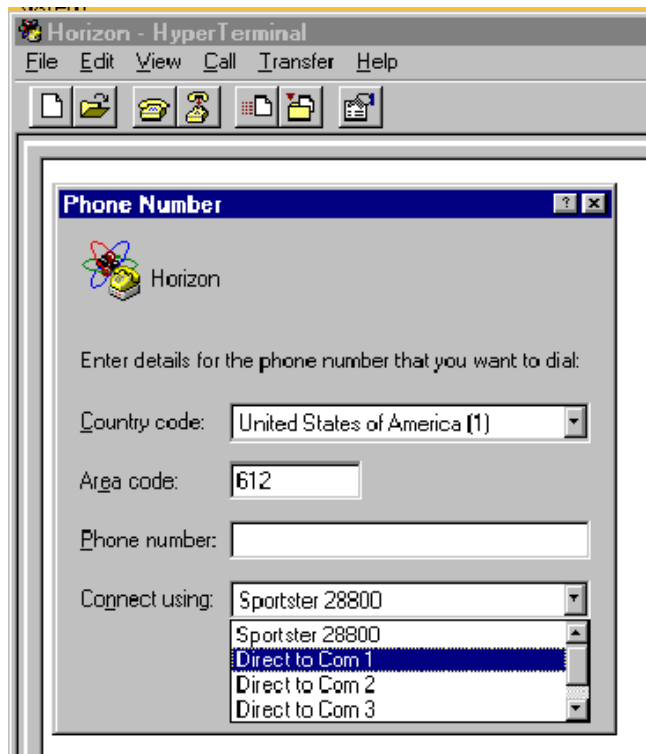

- Set the **COM1 Properties** as shown below (Baud Rate-9600, Data Bits-8, Parity-None, Stop Bits-1, Flow Control-None), then select **OK**.

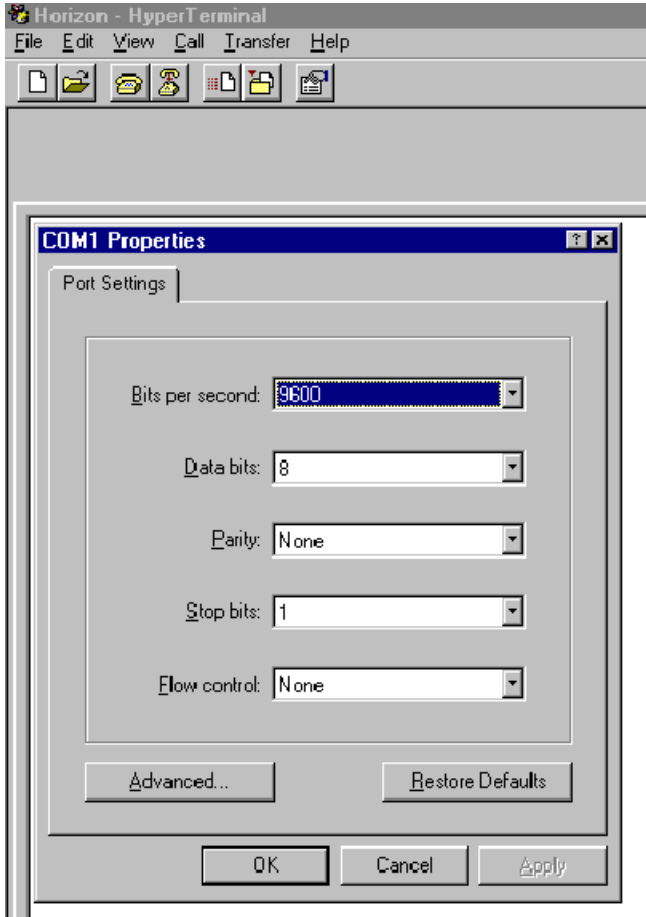

- Pull down the terminal **File** menu and select **Save As**.
- Type in the desired **File Name** (example: HORIZON.TRM).
- Make sure the **Save Files of Type** is set to **Terminal Files (*.TRM)**.
- Select the desired **Drive** and **Directory** where you want the Horizon terminal definition to be saved.
- Select **OK**.

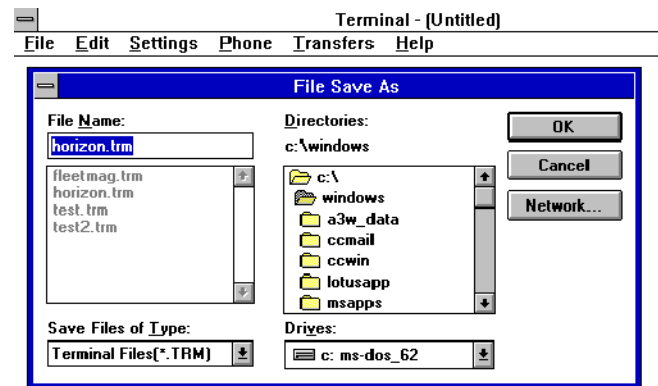

Computer: Receiving Horizon Data

Windows 95

Saving Horizon Job Records to the Computer

Follow these steps to save the Horizon job records to the computer disk. You can save the job records to files with each day's date (for example: 11-19-97.TXT). If the job records are not saved, they will scroll off the terminal program screen and the information will be lost.

1. When you want to save data from the Horizon system to the computer disk, pull down the HyperTerminal **Transfer** menu and select **Capture Text**.

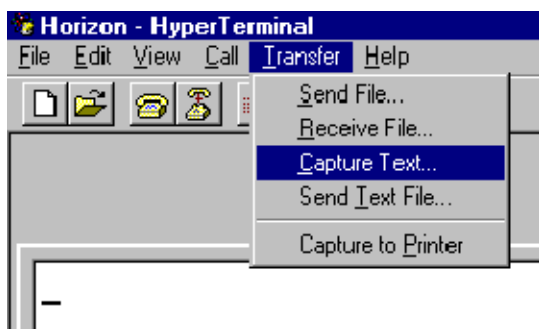

2. Make sure the **Save Files of Type** is set to **Text Files (*.TXT)**.
3. Select the desired **Drive** and **Directory** where you want the Horizon data to be saved.
4. Type in the desired **File** name.
5. Select **Start**.

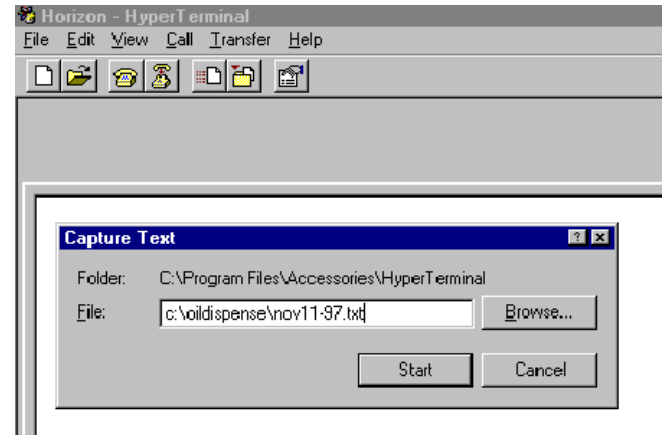

Run Mode

Instructions

Startup Screen

This screen is displayed for four seconds after the system is turned on, then the *Mode Selection* screen (or HOME screen) appears. If the system was turned on previously, you will not see this startup screen.

1. Mode Selection (HOME)

This is the HOME screen. It is the destination any time the HOME button on the keypad is pressed.

- a.. Cursor is at RUN.
- a. Press ENTER on the keypad.

2. Enter Password

The password is optional and is determined by what is entered during setup. Get your password from your system administrator.

- a.. Cursor is in the PASSWORD field.
- b.. Type the password.
- a. Press ENTER on the keypad.

3. Run Mode

- a.. RUN screen appears.
- b.. Cursor is at NEW JOB.
- c.. Press the ↑ or ↓ key to scroll to the Run Option you want to use.
- d.. Press ENTER on the keypad.

NOTE: REPORT JOBS option only appears on the keypad connected to the Master Control Module.

Screens

STARTUP Screen

```
HORIZON
REV X.XX
GRACO INC
COPYRIGHT XXXX
```

HOME Screen

```
-----▶ HOME ◀-----
| RUN |
| INVNT |
```

PASSWORD Screen

```
ENTER PASSWORD
RUN MENU
|XXXX|
```

RUN Screen

```
-----▶ RUN ◀-----
| NEW JOB |
| VIEW CURRENT JOBS |
| REPORT JOBS |
```

Run Mode - New Job

Follow this procedure to start a fluid dispense job.

Instructions

1. Select New Job

With the cursor at NEW JOB on the RUN screen, press ENTER on the keypad.

2. Enter Vehicle Data

The job number, vehicle ID, and the custom input field are optional. What is necessary to enter is determined during setup. You may see some, all, or none of the following prompts for entries.

- a.. RUN NEW JOB screen appears.
- b.. Cursor is in the JOB NUMBER field.
- c.. Type the job number.
- d.. Press ENTER on the keypad.
- e.. Cursor moves to the VEHICLE ID field.
- f.. Type the vehicle ID number.
- g.. Press ENTER on the keypad.
- h.. Cursor moves to the custom input field. In this example, MILES has been entered during set-up to record the odometer reading of the vehicle being serviced.
- i.. Type the necessary information in the custom input field; up to 7 letters or numbers allowed.
- a. Press ENTER on the keypad.

Screens

RUN NEW JOB Screens

```
-----▶ RUN ◀-----  
NEW JOB  
VIEW CURRENT JOBS  
REPORT JOBS
```

```
-----▶ RUN NEW JOB ◀-----  
JOB NUMBER: █-----
```

```
-----▶ RUN NEW JOB ◀-----  
JOB NUMBER: XXXXXXX  
VEHICLE ID: █-----
```

```
-----▶ RUN NEW JOB ◀-----  
JOB NUMBER: XXXXXXX  
VEHICLE ID: XXXXXXX  
MILES: █-----
```

Run Mode – New Job

Instructions

3. Dispense Request

NOTE:

- Only valid dispense areas for the selected fluid are accepted as an entry.
- If an invalid fluid or dispense area number was entered, a RUN ERROR screen will appear. Pressing any key will return the screen to the previous valid screen.
- If there is only one valid dispense area in the system (such as for a lube truck), steps 3d. to 3f. will be omitted.
 - a.. Cursor is in the select fluid number field (SEL FL). 01 is the default fluid. The fluid name (PENNZ 10W30) is displayed after the fluid number.
 - b.. Display the fluid to be dispensed either by entering the fluid number or by pressing the ↑ or ↓ key to scroll through the options.
 - c.. Press ENTER on the keypad to select the fluid.
 - d.. Cursor moves to the dispense area number field (SEL DA).
 - e.. Type in the number for the desired dispense area or press the ↑ or ↓ key to scroll through the options.
 - f.. Press ENTER on the keypad.
 - g.. Dispense area name will display, following dispense area number.
- a. To select a preset dispense, follow step 4. To select a free flow dispense, follow step 5.

Screens

DISPENSE REQUEST Screens

```
SEL FL:01 PENNZ10W30
SEL DA:01 BAY1
```

```
SEL FL:02 PENNZ5W20
SEL DA:03 BAY3
```

RUN ERROR Screen for Invalid Fluid

```
RUN ERROR:
INVALID FLUID

USE ANY KEY TO CONT.
```

Run Mode – New Job

Instructions

Screens

4. Preset Dispense

NOTE:

- The unit of measurement (in this example, QT or quart) is entered during the System Setup. There are four units of measurement available: quarts, liters, gallons, and pints.
- The job will end by either reaching the preset amount or by timing out because the job was interrupted or was never initiated.
 - a.. The PRESET AMOUNT field appears with the cursor on **YES**.
 - b.. Press ENTER on the keypad while the YES is displayed.
 - c.. The ENTER AMT field appears on the fourth line.
 - d.. Type in the amount you want to dispense (maximum of 999.9).
 - e.. Press ENTER on the keypad.
 - a. Continue with step 6.

5. Free Flow Dispense

NOTE: Since there is no preset amount when using free flow dispense, the job will remain open until the set time out period is reached.

- a.. The PRESET AMOUNT field appears with the cursor on **YES**.
- a. Press the ↑ or ↓ key to scroll to **NO**. Press ENTER on the keypad while the NO is displayed.

6. Dispense Confirmation

- a.. Dispense amount, fluid name, dispense area number and name are displayed on lines two and three, under READY TO DISPENSE.
If operating with free flow dispense, the system will display XXX.X in the dispense amount field.
- b.. Cursor moves to the **YES** in the CORRECT? field.
- a. *If the information is correct, press ENTER on the keypad while the YES is displayed.
If the information is not correct, press the ↑ or ↓ key to scroll to NO. Press ENTER on the keypad while the NO is displayed and re-enter the data.*

PRESET DISPENSE Screen

```
SEL FL:02 PENNZ5W20
SEL DA:03 BAY3
PRESET AMOUNT?: YES
```

```
SEL FL:02 PENNZ5W20
SEL DA:03 BAY3
PRESET AMOUNT?: YES
ENTER AMT: 000.0 QT
```

FREE FLOW DISPENSE Screen

```
SEL FL:02 PENNZ5W20
SEL DA:03 BAY3
PRESET AMOUNT?: NO
```

CONFIRMATION Screens

Preset Dispense

```
READY TO DISPENSE:
004.0 QT PENNZ5W20
TO DA 03 BAY3
CORRECT? YES
```

Free Flow Dispense

```
READY TO DISPENSE:
XXX.X QT PENNZ5W20
TO DA 03 BAY3
CORRECT? YES
```

Run Mode - New Job

Instructions

7. Dispense

- a.. After the dispense is confirmed, if the system does not detect any problems, it will turn on the correct fluid and/or air solenoids, enable the meter pulse count, and start the time out clock.
- b.. The ENTRY ACCEPTED or the ENTRY REJECTED screen will appear. Wait for the next screen to appear with the actual status of the job before pressing another key.

NOTE: The length of time it takes to process the job is dependant on how many fluids are being configured on the system.

- c.. ENTRY ACCEPTED: STATUS: ACTIVE means that the solenoids have been activated and the system is ready to dispense. Up to 12 jobs can be accepted into the active queue per system.

ENTRY ACCEPTED: STATUS: WAITING means that there is a utilization conflict, which has placed the job in the waiting queue. The job will start as soon as the conflict is eliminated.

ENTRY REJECTED: STATUS: SYSTEM FULL means that there are 24 jobs in the system already. No more jobs can be entered until at least one of the active jobs is completed.

NOTE: Go to the VIEW CURRENT JOBS screens to monitor job status. See page 54.

ENTRY REJECTED: STATUS: PRINT BUFFER FULL means that no more jobs can be entered until the printer buffer empties.

Screens

ENTRY ACCEPTED Screen

```
ENTRY ACCEPTED
STATUS:
Processing...
```

Status: Active

```
ENTRY ACCEPTED
STATUS: ACTIVE
HIT BACK KEY TO CONT.
```

Status: Waiting

```
ENTRY ACCEPTED
STATUS: WAITING
USE BACK KEY TO CONT.
```

ENTRY REJECTED Screen

Status: System Full

```
WARNING
ENTRY REJECTED
SYSTEM FULL
USE BACK KEY TO CONT.
```

Status: Print Buffer Full

```
WARNING
ENTRY REJECTED
PRINT BUFFER FULL
USE BACK KEY TO CONT.
```

Continued on the next page.

Run Mode - New Job

Instructions

7. Dispense (continued)

- d.. Dispense the fluid.
If the dispense was “preset”, the job will end by either reaching the preset amount or by timing out (see page 39) because the job was interrupted or was never initiated.
If using “free flow” dispense, the fluid will dispense whenever the operator activates the dispense device. The job will end when the preset time out period is reached (see page 39).
- e.. After the job ends, it will be reported on the printer or computer if the system is configured for either printer or computer reporting.
- f.. The next job in the “waiting” queue will move up to the “active” queue.
- g.. Press the back key on the keypad to get back to the RUN screen.
- a. Enter additional jobs as needed.

Screens

RUN Screen

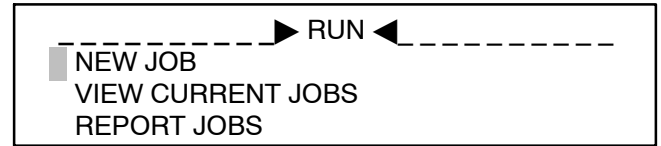

Run Mode - View Current Jobs

Follow this procedure to check the status of dispense jobs.

Instructions

1. Select View Current Jobs

- a.. At the RUN screen, move the cursor to VIEW CURRENT JOBS by pressing the ↑ or ↓ key.
- a. Press ENTER on the keypad.

2. View Current Jobs

- a.. The oldest job in the system is displayed.
 - **ACTIVE** in line one means that the solenoids have been activated and the system is ready to dispense.
WAITING in line one means that there is a utilization conflict, which has placed the job in the waiting queue. The job will start as soon as the conflict is eliminated.
 - NOTE:** When the job is complete, it is removed from the active queue and will not appear on the screen.
 - **12:01** in line one of the Active Job is the time the job was entered.
JOE is the identification of the operator.
 - The second line shows the requested amount and name of the dispense fluid.
 - The third line shows the dispense location.
 - The fourth line is the STATUS field, which shows the amount of fluid that has been dispensed or is being dispensed.
- b.. Press the ↑ or ↓ key to move to the next job.
 - a. If the active and/or waiting jobs are complete, the NO JOBS IN QUEUE screen will appear. Press the BACK key to exit.

Screens

RUN Screen

```
-----▶ RUN ◀-----
NEW JOB
VIEW CURRENT JOBS
REPORT JOBS
```

VIEW CURRENT JOBS Screens

Active Job

```
ACTIVE      12:01  JOE
004.0 QT PENNZ5W20
TO BAY3
STATUS:     003.0 QT  ↓↑
```

Waiting Job

```
WAITING     12:01  JOE
05.0 LT 5W30
TO BAY1
STATUS:     000.0 LT  ↓↑
```

NO JOBS IN QUEUE Screens

Active Job

```
THERE ARE NO JOBS
IN THE ACTIVE QUEUE
USE ↓↑ FOR MORE
USE BACK KEY TO EXIT
```

Waiting Job

```
THERE ARE NO JOBS
IN THE WAITING QUEUE
USE ↓↑ FOR MORE
USE BACK KEY TO EXIT
```

Run Mode - Report Jobs

Follow this procedure to retrieve reports on previously completed jobs.
This run option is only available on the Master Control Module.

Instructions

1. Select Report Jobs

NOTE:

- REPORT JOBS can be initiated when jobs are running, however, if a job completes and sends the information to the printer or computer, the report will be interrupted. It is best to run reports when no jobs are running.
- The system can hold up to 668 transactions before it begins to write over the oldest jobs.
- See page 40 for information about printer and computer output. The report will be formatted as set in COMM. on CM#1. See page 37.
 - a.. At the RUN screen, move the cursor to REPORT JOBS by pressing the ↑ or ↓ key.
 - a. Press ENTER on the keypad.

2. Report Jobs

- a.. The REPORT JOBS screen appears with the cursor in the DATE field.
- b.. Type in the date you want the report to start with.
- c.. Press ENTER on the keypad. The cursor will move to the TIME field.
- d.. Type in the time you want the report to start with. Note that the Horizon has a 24 hour clock.
- e.. Press ENTER on the keypad.
- f.. The REPORT IN PROCESS screen will appear. Wait for the COMPLETED screen to appear before pressing another key.

NOTE: The length of time it takes to process the report is dependant on how many jobs were running in the requested report period and whether the printer or computer is busy processing other jobs.

If the system could not find jobs to report within the time and date parameters called for, the WARNING screen will appear.

- a. After the COMPLETED screen appears, press any key on the keypad to return to the RUN screen.

Screens

RUN Screen

```
-----▶ RUN ◀-----
NEW JOB
VIEW CURRENT JOBS
█ REPORT JOBS
```

REPORT JOBS Screen

```
          RPT ALL JOBS SINCE
DATE (MMDDYY)  XXXXXX
TIME (HH:MM)   XX:XX
```

```
          RPT ALL JOBS SINCE
DATE (MMDDYY)  XXXXXX
TIME (HH:MM)   XX:XX
```

```
          REPORT IN PROCESS...

          PLEASE WAIT
```

```
          JOB REPORTS
          SUCCESSFULLY
          COMPLETED
          USE ANY KEY TO CONT.
```

WARNING Screen

```
          WARNING
          NO JOB REPORTS FOUND

          USE ANY KEY TO CONT.
```

Inventory Mode

Instructions

Startup Screen

This screen is displayed for four seconds after the system is turned on, then the *Mode Selection* screen (or HOME screen) appears. If the system was turned on previously, you will not see this startup screen.

1. Mode Selection (HOME)

NOTE: This is the HOME screen. It is the destination any time the HOME button on the keypad is pressed.

- a.. Move the cursor to INVNT (inventory) by pressing the ↑ or ↓ key.

NOTE: The inventory option can only be modified on the administrator keypad.

- a. Press ENTER on the keypad.

2. Enter Password

NOTE: Inventory mode cannot be accessed without a password. Get your password from your system administrator if you have inventory access.

- a.. Cursor is in the PASSWORD field.
- b.. Type the password.
- a. Press ENTER on the keypad.

3. Inventory Mode

NOTE: TANK LEVELS and REPORT INVENTORY will not appear on the screen if they were not enabled during setup. See page 36.

- a.. INVENTORY screen appears.
- b.. Cursor is at TANK LEVELS.
- c.. Press the ↑ or ↓ key to scroll to the Inventory Option you want to use.
- a. Press ENTER on the keypad.

Screens

STARTUP Screen

```
HORIZON
REV X.XX
GRACO INC
COPYRIGHT XXXX
```

- b. Press ENTER on the keypad.

HOME Screen

```
-----▶ HOME ◀-----
  RUN          SETUP
  █ INVNT
```

PASSWORD Screen

```
ENTER PASSWORD
INVENTORY MENU
  █XXXX
```

INVENTORY Screen

```
-----▶ INVENTORY ◀-----
  █ TANK LEVELS
  HISTORY TOTALS
  REPORT INVENTORY
```

Inventory Mode - Tank Levels

Follow this procedure to check and add to the levels of your fluid tanks.

Instructions

1. Select Tank Levels

With the cursor at TANK LEVELS on the INVENTORY screen, press ENTER on the keypad.

NOTE: If a low level alarm (LOW FLXX) has appeared on the HOME screen, following this procedure and adding the fluid called for will clear the alarm.

2. Tank Levels

a.. The TANK LEVELS screen appears with the cursor in the FL# (fluid number) field. The screen will show the fluid #01 tank level in gallons or liters.

NOTE: Unit of measurement is determined during setup. See page 32.

- b.. Press the ↓ ↑ arrow keys to view the various fluids setup in inventory. Press ENTER when the fluid you wanted appears on the screen.
- c.. The cursor will move to the ADD field. The default selection is NO.
- Press the ↓ ↑ arrow keys to change to YES if you are adding fluid to your tanks. Press ENTER and an amount field will appear. Follow the instructions in step 3, below.
 - Entering NO will move the cursor to MORE. Follow the instructions in step 4, below.

3. Add Fluid to the Tanks

- a.. The cursor moves to the amount field. Type in the number of gallons or liters of fluid being added to the tank and press ENTER.
- a. The tank level amount will increase accordingly and the cursor will move to MORE.

4. More or Exit

- a.. Entering MORE will take you to the next fluid that was setup in inventory.
- b.. Press the ↓ ↑ arrow keys to move the cursor to EXIT and press ENTER to go to the SAVE INVNT screen.

Save Inventory

Follow the **Save Inventory** procedure on page 60.

Screens

INVENTORY Screen

-----▶ INVENTORY ◀-----
█ TANK LEVELS
HISTORY TOTALS
REPORT INVENTORY

TANK LEVELS Screen

FL# 01	5W30
XXXXX.X GL	TANK LVL
ADD?	
MORE	EXIT

FL# 01	5W30
XXXXX.X GL	TANK LVL
ADD? NO	USE ↓ ↑
MORE	EXIT

FL# 01	5W30
XXXXX.X GL	TANK LVL
ADD? YES	00000.0 GL
MORE	EXIT

FL# 01	5W30
XXXXX.X GL	TANK LVL
ADD?	
█ MORE	EXIT

Inventory Mode - History Totals

Follow this procedure to view how much fluid has been used over a given period of time.

Instructions

1. Select History Totals

With the cursor at HISTORY TOTALS on the INVENTORY screen, press ENTER on the keypad.

2. History Totals

- a.. The HISTORY TOTALS screen appears with the cursor in the RESET field, on NO.
The screen will show the fluid #01 tank level in gallons or liters.
NOTE: Unit of measurement is determined during setup. See page 32.
- b.. The first line of the HISTORY TOTALS screen is a non-resettable total. The total will only reset to zero when new software is installed.
- c.. The second line is a resettable total. If the history level has never been reset, the line after the word SINCE will be blank. If the level has been reset previously, this line will show the hour, minute, and second (HH:MM:DD) and the month, day, and year (MM:DD:YY) when the level was reset. Note that the Horizon has a 24 hour clock.
- d.. Entering NO will move the cursor to MORE. Follow the instructions in step 4, below.

3. Reset Tank History Amount

- a.. Press the ↓ ↑ arrow keys to change RESET? NO to RESET? YES and press ENTER.
- b.. The second line of the tank history will reset to zero and will time-stamp the entry with the time and date, and the cursor will move to MORE.

4. More or Exit

- a.. Entering MORE will take you to the next fluid that was setup in inventory.
- b.. Press the ↓ ↑ arrow keys to move the cursor to EXIT and press ENTER to go to the SAVE INVNT (inventory) screen.

Save Inventory

Follow the **Save Inventory** procedure on page 60.

Screens

INVENTORY Screen

```
-----▶ INVENTORY ◀-----
TANK LEVELS
█ HISTORY TOTALS
REPORT INVENTORY
```

HISTORY TOTALS Screen

```
XXXXXXXX.X GL FL# 01
XXXXXXXX.X GL SINCE

RESET? █ NO MORE EXIT
```

```
XXXXXXXX.X GL FL# 01
XXXXXXXX.X GL SINCE

RESET? █ YES MORE EXIT
```

```
XXXXXXXX.X GL FL# 01
XXXXXXXX.X GL SINCE
HH:MM:SS MM-DD-YYYY
RESET? █ MORE EXIT
```

Inventory Mode - Report Inventory

Follow this procedure to print out the inventory levels of the fluid tanks.

Instructions

1. Select Report Inventory

With the cursor at REPORT INVENTORY on the INVENTORY screen, press ENTER on the keypad.

2. Report Inventory

NOTE: REPORT INVENTORY can be initiated when jobs are running, however, if a job completes and sends the information to the printer or computer, the report will be interrupted. It is best to run reports when no jobs are running.

- a.. The REPORT INVENTORY screen appears, showing that the system is sending the data to the printer from the Master Control Module.
- b.. Wait for the PRINT INVENTORY FINISHED screen before pressing another key.

NOTE: The length of time it takes to print is dependant on how many fluids are being configured on the system.

- c.. The printout will show the current fluid levels of the tanks that are being monitored by the inventory System. The data prints out in computer or printer format, depending on what was selected during setup. See page 37. See page 40 for information on computer output.
- d.. Press any key to return to the INVENTORY screen.

Screens

INVENTORY Screen

```
-----▶ INVENTORY ◀-----
TANK LEVELS
HISTORY TOTALS
█ REPORT INVENTORY
```

REPORT INVENTORY Screen

```
PRINTING INVNT...

PLEASE WAIT
```

```
PRINT INVENTORY
FINISHED!!!

USE ANY KEY TO CONT.
```

Inventory Report Printout - Example

```
INVENTORY REPORT
*****

FLUID 02 WASH    00010.0 GL IN TANK
FLUID 01 5W30   00055.0 GL IN TANK
```

Inventory Mode - Save Inventory

Instructions

Save Inventory

CAUTION

Inventory entries cannot be saved if there are any active or waiting jobs in the system. The INVENTORY CANNOT BE SAVED screen will appear.

1. The SAVE INVNT (inventory) verification screen will appear with the cursor on **NO**. Pressing ENTER with NO selected, will return you to the INVENTORY screen without saving.
2. Scroll to YES by pressing the ↓ or ↑ key.
3. Press ENTER on the keypad to save the inventory option.
4. A screen will appear to notify you that your save was successful. Press any key on the keypad to return to the INVENTORY screen.

Screens

SAVE INVENTORY Screen

SAVE INVNT: ► NO ↑↓
WARNING:
JOBS MUST NOT BE
ACTIVE/WAITING

INVENTORY CANNOT BE SAVED Screen

INVENTORY CANNOT BE
SAVED BECAUSE JOBS
ARE ACTIVE/WAITING
USE ANY KEY TO CONT.

SAVED SUCCESSFULLY Screen

INVENTORY SAVED
SUCCESSFULLY !!!

USE ANY KEY TO CONT.

Installation and Troubleshooting Tips

General Precautions

WARNING

To reduce the risk of serious injury, read and follow the warnings on page 4.

- Never connect or disconnect system components with the power turned on. In addition to being a safety hazard, failure to turn off the power can damage the equipment.
- When there are any active or waiting jobs in the system:
 - Never save any setup information (such as new operators and passwords, inventory updates, etc.)
 - Never CLEAR any system tables under SETUP when there are any active or waiting jobs.
 - Never UPDATE TABLES under SETUP when there are any active or waiting jobs.

Use the RUN ► VIEW CURRENT JOBS screen to check the status of system jobs prior to making changes. See page 54. This is to ensure that the changes made do not accidentally change a system resource that is assigned to an active job.

NOTE: Remember to reboot the system after saving changes.

- Do not SAVE, CLEAR or UPDATE any tables under SETUP while the system is printing any job transaction reports.
- Do not print an Inventory Report while there are job reports printing or in the active or waiting queues. Job reports always have the highest priority at the printer and may override the inventory printout, giving potentially confusing information.

System Components and Installation Overview

Control Module

Check each control module prior to mounting it on the wall.

1. Modify a power cord so it has a plug on one end and stripped wires on the other end to use to power the control module at the workbench.
2. Attach the power cord to the control module.
3. Attach a keypad (any variety).
4. Turn on the power to the control module. It will “boot up” and display first a dash in the upper left hand corner, then the software version level, and finally the HOME screen (with RUN, INVT and SETUP options).

If the keypad stays on the dash for more than 10–15 seconds, either the memory chips on the circuit board or the keypad itself is damaged. Verify the cause by swapping parts.

NOTE: It is a good practice to setup a control module or two, some solenoids and meters, and the printer on a workbench, prior to installing the system. This will allow you to get comfortable with the connections, the process, and the diagnostic functions in a more controlled environment.

Programming Off-site

If programming the Master Control Module off-site, away from the rest of the network, **turn off the CAN before starting to program**. See page 21. If you do not turn off the CAN, the module will appear to “lockup” after saving.

When installing the Master Control Module into the network, be sure to turn the CAN back on before updating the tables across the network (copying the setup information to each Control Module).

Installation and Troubleshooting Tips

Keypad

The keypad sends keystrokes to the control modules and receives characters back to write on the screen. It contains none of the Horizon system programming information that is entered during Setup. It does have some internal, microchip-based programming of its own, to translate keystrokes and screen data, and should be treated as any keyboard or computing device would be handled.

Cabling

Check the cable routing and connections before turning on the power to the Horizon system for the first time. Pay particular attention to the meter connections; if wired incorrectly, the meters or control modules can be damaged.

New Installation Startup

Start a new installation by using CLEAR SETUP ► ALL MEMORY to erase the control module(s) memory. See page 23. This will initialize all the tables and remove any data accidentally left after testing in the factory. It will also delete the factory-provided password of 1111, so before exiting SETUP, make sure you have added a password with SETUP access.

CAUTION

If the Master Control Module was programmed off-site, do not CLEAR ALL MEMORY! It will erase the setup information you entered earlier. Instead, follow the procedure below.

If Master Control Module was programmed off-site:

1. Leave the Master Control Module connected to the network. It provides a terminating resistor for the network cable that is needed to ensure the data travels across the cable correctly.
2. Turn off the power to the Master Control Module and move to one of the Slave Control Modules.

NOTE: As long as the Master Control Module is turned off, it will not respond to the CLEAR command and your data entries will be preserved. However, the rest of the network will clear and be ready to receive the system map from the Master Control Module.

3. Use the password 1111 to enter Setup. Move the cursor down to CLEAR SETUP and press ENTER. Press ENTER again to select ALL MEMORY. Answer YES to the prompt.

Controller Area Network (CAN)

Each control module in a system has a complete set of the tables and data that you enter with the Administrative Keypad on the Master Control Module. This is necessary to support initiation of a dispense job from anywhere on the system.

NOTE: The CAN must be enabled before the Master Control Module can broadcast information. See page 21.

Each time you complete entry of a table (for example, Operator Passwords) and then exit, the software asks if you want to SAVE your entries. If you say YES, the Master Control Module broadcasts that table to all Slave Control Modules on the CAN network.

Possible Problems

The Master Control Module will wait for an acknowledgement that at least one of the Slave Control Modules received the data. If it does not receive a reply, it will remain at the UPDATING TABLES - PLEASE WAIT message screen indefinitely. If this happens, and the CAN is ON on the Master Control Module, the Slave Control Modules are off-line. This can be caused by the CAN ENABLE/DISABLE being set incorrectly (see page 21) or the CAN cable is not connected properly.

Control Module Address

Each Control Module must have a unique address on the CAN network. These are set using the block of DIP switches on the board at installation time. See page 8. The switch settings and their corresponding address can also be read using SETUP ► DIAGNOSTICS ► DIPSWITCHES. See page 27. The screen will show the condition of each of the eight switches, and the control module address the switches translate to will be at the bottom of the screen.

Installation and Troubleshooting Tips

Installing and Troubleshooting a New Operating System Version

Installation

New versions of the Horizon operating system will periodically be released in the form of a set of three microchips, known as *firmware*. The chips are located on the circuit board of each control module (master and slave), and are designated U6, U7 and U11. See page 71 for instructions on installing the new chips (software).

Powering Up the System

After changing the chips in each control module, the control module can be powered up. The attached keypad should boot up normally, displaying the HOME screen after 10–15 seconds. If the HOME screen does not appear, take a close look at the pins on each chip you replaced. If a pin is bent or not making contact with the connector, it can prevent the control module from operating properly.

Verifying the Version

The software version of these chips is marked on them, but it can also be determined by going into SETUP ► DIAGNOSTICS ► ABOUT. See page 26. All control modules in the system need to have the same version of the firmware loaded.

The ABOUT screen also gives information about the condition of the information contained in the memory chips, also known as “Checksum”.

- The line labeled FIRMWARE CKSUM (checksum) will display four characters, which should be the same on all control modules. If it is not the same, the program has been damaged.
- After all the SETUP information has been loaded, *but before any jobs have been entered*, the line labeled DATA CKSUM on each control module should match. If they do not match, the transmission of the tables from the Master Control Module to the Slave Control Module was not completed successfully and should be done again.
 - a. Check the condition of the CAN cable and ensure that the CAN is enabled on all the control module. See page 64, **Problem: Network communication is not operating properly**.

- b. Try SETUP ► UPDATE TABLES ► ALL TABLES to send the tables again (page 25), or you may have to CLEAR SETUP ► ALL MEMORY (page 23) to erase the memory of all control modules before sending the tables again.

NOTE: After jobs have been entered, the line labeled DATA CKSUM will vary depending upon the exact system configuration and what jobs are currently active on the system at the time.

Rebooting

After verifying that the checksums match on all control modules, and the system configuration has been successfully downloaded to each control module, turn the power off, wait 10 seconds, and turn the power back on to all boxes.

Run a test job to each dispense point to verify proper operation. See the other sections for troubleshooting any problems that may have occurred since the firmware was changed.

Reboot After Setup or System Changes

The entire system (all control modules) needs to be rebooted after entering the system setup data and after making any system changes, such as adding new operators/passwords, updating inventory information, etc.

Printing Configuration Information

You can print out the system configuration information using SETUP ► PRINT SETUP ► ALL MEMORY or select individual tables to print. See page 24.

NOTE:

The numbering scheme of the printout will not match the numbering scheme of your data entry. Many of the parameters that were entered, starting with 1, 2, 3, etc., will begin with 0, 1, 2, 3, etc., in the printout. This is due to the internal numbering scheme of the operating software.

To match the printout with the tables used for data entry, subtract 1 from each entry.

For example: solenoid ports are numbered 1–6 externally, 0–5 internally; meters are 7–12 externally, 6–11 internally.

Installation and Troubleshooting Tips

Troubleshooting System Components

Controller Area Network (CAN)

Problem: Network communication is not operating properly.

- Under SETUP, the first option is ENABLE CAN. Make sure the CAN is enabled. Follow the procedure on page 21. Both types of control modules (master and slave) ship from the factory with CAN enabled.
- Check the condition of the CAN cable. Check visually or use DIAGNOSTICS ► CAN to check out the CAN cable between control modules. See page 28.
 - c. Put a keypad on the control modules at far ends of the cable.
 - d. MANUALLY TEST CAN on each keypad. See page 28. If the CAN cable is connected properly, each keystroke typed on one keypad will display on the other keypad(s). This verifies that the cable is properly wired, and each plug is properly inserted in each intermediate control module.
 - e. To verify that each intermediate control module is on-line, move to the remaining keypad/control module(s). Type the address number for each control module on its keypad and watch the other keypads for that number to appear.

Solenoids

Problem:

- Use DIP Switch #8 to turn on all the solenoids. See Fig. 1, page 10.

NOTE: The switch only turns on the solenoids attached to that Control Module.

With the solenoids on, verify the wiring to the solenoids and ready lights, flush out the plumbing lines, and allow fluid to flow to check the meter pulses.

- Use DIAGNOSTICS ► SOLENOIDS to turn on individual solenoids. See page 26.

NOTE: The Diagnostics work only on the control module the keypad is attached to; you can not turn on a solenoid on a remote control module using Diagnostics.
- Verify that each ready light corresponds to the proper solenoid. It is possible to have the light wired to the wrong solenoid, which would produce a symptom where either the right light comes on and there is no fluid available, or the wrong light comes on but the right fluid flows.

There are six LED lights on the control module circuit board, next to the solenoid connectors. They will light whenever a solenoid is signalled to turn on.

Test the LEDs:

- f. Using DIP Switch #8,
- g. Using SETUP ► DIAGNOSTICS ► SOLENOIDS,
- h. Or by entering an actual dispense job.

When first starting up a new system, start testing by using switch #8. This will allow you to check out all solenoids on a control module at once. If the LEDs are on at the circuit board, but the ready lights are not on at the dispense point, check the cable from the control module to the dispense point. Then use DIAGNOSTICS ► SOLENOIDS to ensure that only the expected solenoid opens when signalled.

Installation and Troubleshooting Tips

Meters

Problem:

There are six LED lights on the control module circuit board, in line with the meter connectors. These lights are normally on and blink off momentarily when they receive meter pulses.

- The meter circuitry can be checked by unplugging all three meter connectors and verifying that all six lights remain steadily on. If a light goes off when the connector is plugged back in, the meter may be stopped in the exact position that causes the LED to blink off.
- The functionality of the meter electronics and cabling can be verified by moving a strong magnet across the surface of the meter cover and observing that the LED blinks off and back on.

NOTE: If you are uncertain about the magnet strength, try the test on a known good meter and control module on the workbench first.

- You can use DIAGNOSTICS to verify the operation of the meters. This can be done before there is any fluid in the system.
 - i. If the meter is attached properly to a powered up control module, a magnet can be moved across the surface of the meter cover (see previous bullet).
 - j. Pulses will be generated that can be counted in SETUP ► DIAGNOSTICS ► METERS ► MONITOR METERS. See page 27.

NOTE: The meter numbers under DIAGNOSTICS refer to the ports the meters are attached to on that control module (#7-12), not to meter numbers assigned in the programming steps.

k. Make sure that the pulses are showing up at the expected meter port.

- The final step in checking meters is to run fluid through them, and verify that they count properly.
 - l. Turn on all the system solenoids using switch #8 in each control module (see previous section on solenoids).
 - m. Dispense fluid from each hose drop while watching the meter LEDs and DIAGNOSTICS screens for pulses.
 - n. After each meter has been verified, change switch #8 back to normal “on” position at each control module.
 - o. Run a sample job to each dispense point.

NOTE: Configuration tables (setup) must be loaded to run a job.

Printer

The thermal printer offered by Graco for the Horizon system needs to be configured for proper operation. You may have an “old style” or a “new style” printer; they require different steps to setup. See page 17 and/or the manuals included with the printer to set it up.

If using a different printer, it must have a serial RS-232 port; most printers sold at computer stores now have parallel interface ports only. You will need to modify the Graco printer cable or build a special cable as the pin assignments on most brands of printers are different. See page 17 for the pin assignments for the Horizon end of the cable; the printer manual will give information on the printer cable end.

Installation and Troubleshooting Tips

Possible Problems and Solutions

1. The correct ready light comes on but no fluid flows.

- a. Make sure the valves in the fluid line are open.
- b. Check the filters and other plumbing components for clogs.
- c. If the nozzle twists to open, verify it is in the open position.
- d. Verify that there is air pressure to the pump.
- e. The proper air solenoid is activated by the job request (*for example, if oil is requested, only the oil pump air solenoid should be on*).
- f. The air pressure regulator is set correctly.
- g. The necessary valves are open.
- h. Check if fluid is available at some other dispense point.

Use DIP Switch #8 on the control module the air solenoids are attached to pressurize the pumps. Then use Switch #8 or the DIAGNOSTICS ► SOLENOIDS to selectively check out each dispense point. Reference the information under **Solenoids** on page 64.

If none of the dispense points operate, the problem is at the pump room end.

If only one dispense point is not operating, the problem is at the dispense point. Follow the next step.

- i. If after completing the above checks there is still no fluid flow to a specific dispense point, begin at the upstream end of the dispense point hardware (typically a ball valve or check valve) and check each component to determine where the problem is.

2. A different ready light comes on than the one expected, and fluid flows at the dispense point indicated by the light.

Check for proper light/solenoid activation, using DIAGNOSTICS ► SOLENOIDS. Reference the procedure under **Solenoids** on page 64.

If the light/solenoid activates correctly, the system configuration entered during programming is wrong. Check the ASSIGN CONNECTIONS table (see page 34) versus the actual wiring in the shop.

If the light/solenoid does not activate correctly, at the location of the problem, then the wiring itself is wrong. Check your floor plan versus the cabling connections.

3. A different ready light comes on than the one expected, but fluid flows at the expected point.

The ready light is wired to the wrong fluid solenoid. Check your wiring and correct it.

4. The correct ready light glows and fluid flows, but there is no automatic shut-off.

This could be caused by one of two problems:

- a. The appropriate meter is not sending pulses. Reference the information under **Meters** on page 65.
- b. The system configuration information was entered incorrectly, so the system is monitoring the wrong meter for the fluid/dispense point. Using SETUP ► MODIFY SETUP, check both the meter number entry on the ASSIGN CONNECTIONS table (see page 34) and the control module and port number entries in the METER CALIBRATION table (see page 35).

Installation and Troubleshooting Tips

Possible Problems and Solutions

5. Jobs are compiling in the JOBS WAITING queue or never clearing from the ACTIVE queue.

A job that never closes out of the active queue or never prints a report is an indication that one or more control modules on the network have dropped off-line; they may or may not have come back on-line. This is usually caused by power to the control module being momentarily interrupted.

Use the SETUP ► DIAGNOSTICS ► POWER UP screen to check how many times each control module has been turned on. The only way to clear these jobs is to completely reboot the system (all control modules at the same time). Make sure that no new jobs are being entered and no fluid is being dispensed during the reboot.

6. The system will not accept input of any new jobs. This is indicated by a message stating "SYSTEM FULL".

This situation is related to problem 5. Use the RUN ► VIEW CURRENT JOBS screen (see page 54) to check if there are a number of jobs in the active or waiting queues.

A job that is in the active queue will time out after five minutes of inactivity. If a time shown in the queue is more than five minutes old, the job is probably "hung up" and will not clear. To correct this problem, completely reboot the system (all control modules at the same time). Make sure that no new jobs are being entered and no fluid is being dispensed during the reboot.

7. Unable to dispense one or more fluids to a specific location on the network.

- a. Check that the CAN network broadcasts to the target control module.
- b. Check that the solenoids and meters attached to that control module are functioning.
- c. Check that the system configuration information for that Control Module was entered properly. The most likely problem will be errors in the data in the ASSIGN CONNECTIONS table.

Troubleshooting

Problem	Cause	Solution
Keypad screen completely blank	<ol style="list-style-type: none"> 1. No power to control module 2. Keypad cable disconnected 3. Keypad malfunction 4. Control module malfunction 	<ol style="list-style-type: none"> 1. Verify power is on 2. Reconnect cable and cycle power to control module 3. Replace keypad 4. Replace control module
Keypad only displays __	<ol style="list-style-type: none"> 1. Control module not operating properly 2. Keypad malfunction 	<ol style="list-style-type: none"> 1. Cycle power to control module; if still not operating properly, replace control module. 2. Replace keypad
Keypad “locked up” or some keys do not function	Keypad malfunction	Replace keypad
Printer not printing	<ol style="list-style-type: none"> 1. Printer not turned on 2. Paper empty 3. Printer off-line 4. Master control module power off 	<ol style="list-style-type: none"> 1. Turn printer power on 2. Add paper to printer 3. Turn printer “on line” 4. Verify power is on
Job will not dispense	<ol style="list-style-type: none"> 1. Incorrect Setup 2. Fluid empty 3. Air solenoid malfunction 4. Fluid solenoid malfunction 5. CAN communication problem 	<ol style="list-style-type: none"> 1. Verify entered setup matches system map 2. Check fluid level 3. Use Diagnostics→Solenoids to turn on the appropriate air solenoid; if there is no air, check wiring and replace solenoid if needed 4. Repeat step 3, above, for the appropriate fluid solenoid 5. Use Diagnostics→CAN to verify network is functioning properly; if not, verify CAN Enabled in all control modules and check wiring
Job will not shut off	<ol style="list-style-type: none"> 1. Incorrect Setup 2. Flow meter malfunction 	<ol style="list-style-type: none"> 1. Verify entered setup matches system map 2. Use Diagnostics→Meters to check if the control module is receiving meter pulses from the appropriate meter; if not, check wiring and replace meter if needed
Dispense volume inaccurate	<ol style="list-style-type: none"> 1. Flow meter calibration incorrect 2. If using 215474 meter, RC filter not installed 	<ol style="list-style-type: none"> 1. Verify correct calibration entered for appropriate meter 2. Install RC filter
System “locks up” when saving setup information	CAN not enabled on multiple controller system or not disabled on single controller system	Verify CAN enabled for multiple and disabled for single controller system
Printer outputs several old jobs	One controller out of sync with the system (due to power interruption at that controller)	Power down entire system and then reapply power

Maintenance

Shutdown Procedure

⚠ WARNING

ELECTRIC SHOCK HAZARD
To reduce the risk of serious injury, including electric shock or splashing fluid in the eyes or on the skin, follow the **Shutdown Procedure** before servicing any part of the Horizon system and before checking for loose or shorted wires.

1. Turn off the electrical power to all control modules.
2. Shut off the power to the pump(s).
3. Relieve fluid pressure as instructed in your pump and/or dispensing valve manual(s).

Pulse Meter Service

⚠ CAUTION

To avoid damaging the electronic components of the pulse meter module (1) :

1. Do not lay anything on the pulse meter.
2. Be sure the open side of the pulse meter faces up if you lay it down.
3. Do not twist or force parts. Align parts properly as instructed.

NOTE: See page 77 to order pulse meters or replacement parts. The older Electronic Fluid Commander meter, P/N 236763, is not directly compatible with the Horizon system. Replace the electronic pulse module with P/N 239367. See instructions below.

To Replace the Complete Pulse Meter

1. Follow the **Shutdown Procedure** above.
2. Disconnect the cable from the pulse meter, taking note of the wiring polarity.
3. Remove the old pulse meter and install the new one, following the original wiring polarity.

To Replace the Electronic Pulse Module

1. Follow the **Shutdown Procedure** above.

2. Disconnect the cable from the pulse meter, taking note of the wiring polarity.
3. Remove the screws (A). Lift off the electronic pulse module (1). See Fig. 14.
4. Install a new electronic pulse module. Align the notches on the underside of the electronic module with the cutaways in the top of the metering unit (2). Use the new screws and torque them oppositely and evenly to 10 to 12 in-lb (1.2 to 1.4 N•m).
5. Connect the pulse meter wires to the cable, following the original wiring polarity.

To Replace the Metering Unit

1. Follow the **Shutdown Procedure** above.
2. Remove the screws. Lift off the electronic pulse module (1). See Fig. 14.
3. Remove the old metering unit (2).
4. Install a new metering unit. Align the notches on the underside of the electronic pulse module with the cutaways in the top of the metering unit. Use the new screws and torque them oppositely and evenly to 10 to 12 in-lb (1.2 to 1.4 N•m).

P/N 238618 shown

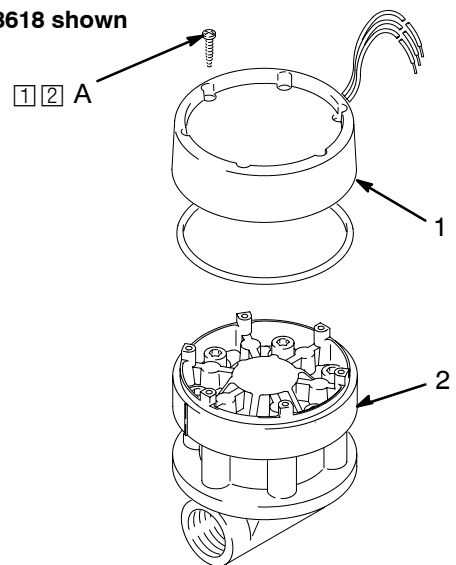

- 1 Replacement screws included with items 1 and 2
- 2 Torque screws oppositely and evenly to 10-12 in-lb (1.2-1.4 N•m)

Fig. 14

06874

Maintenance

⚠ WARNING



ELECTRIC SHOCK HAZARD

To reduce the risk of serious injury, follow the **Shutdown Procedure** on page 69 before servicing any part of the Horizon system and before checking for loose or shorted wires.

NOTE: See page 76 to order solenoid valves or Ready Light Kits. The older Ready Light (with a red lens) is not directly compatible with the Horizon system. Order the new version of the Fluid Solenoid Kit, P/N 218588, which has the new Ready Light (with a green lens), or order the Ready Light Kit, P/N 238996, and install it on the existing solenoids.

To Clean the Solenoid Valve

The solenoid valve is normally closed, but foreign matter could hold the valve open, preventing it from stopping the fluid flow. Clean the valve as instructed below.

1. Follow the **Shutdown Procedure** on page 69. Be sure to open the dispensing valve controlled by the solenoid valve to relieve line pressure.
2. Close the ball valve that is upstream of the solenoid valve.
3. Unscrew the nut (B), remove the operator (C), and unscrew the piston (D) from the body (E). See Fig. 15.

4. Clean the parts and the seat in the body. Blow air into the body to clear the fluid passageways.
5. Assemble the solenoid valve.
6. Dispense fluid at the dispensing valve controlled by the cleaned or replaced solenoid valve until all air is purged from the system.
7. If the problem is not corrected, replace the solenoid valve.

P/N 215487 shown

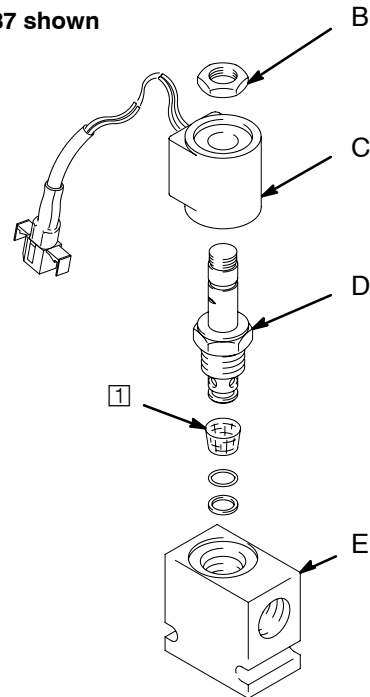

1 P/N 111451 Replacement Screen

Fig. 15

07794

Maintenance

⚠ WARNING



ELECTRIC SHOCK HAZARD
To reduce the risk of serious injury, follow the **Shutdown Procedure** on page 69 before servicing any part of the Horizon system and before checking for loose or shorted wires.

Power Failure

1. Each control module has a built-in backup battery for its memory. When power is restored, the system will reboot to the HOME screen. The total amounts dispensed and all system maps and completed job records will still be in the memory. Jobs that were actively dispensing or waiting in queue when the power failed will not be held in memory.
2. If the system shuts off unexpectedly, switch it off and on again. If the problem continues, first determine if it is caused by problems with the hard wiring. If the problem seems to be with the control module, return it to your Graco Distributor or Installer for repair.

The Control Module is Not User Repairable

The control module is not user repairable. Service is available only at Graco-authorized service centers. Do not attempt to make any repairs yourself.

To Clean The Keypad

Spray mild household cleaner (only) on a soft cloth and wipe the keypad clean. Do not allow the cleaner or any other fluid to get under the front panel.

To Install New Software

1. Turn off the electrical power to the Horizon system.

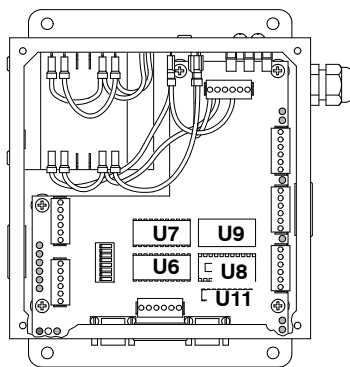

Old Style Control Module

2. Remove the cover from each of the control modules.
3. Identify the new memory chips included with the software upgrade. These are the chips that need to be changed in the control modules.

NOTE: The only memory chips on the board that contain software are U6, U7, and U11. See Fig. 19.

4. Locate the software chips that need to be changed in the control modules. See Fig. 19. Note the chips' location and orientation; there is a slight notch in one end of the chips to orientate them. See Fig. 16.
5. Use an I.C. extraction tool to remove the old software chips. Pull the chips directly up. See Fig 17.

To remove the software chips without an extraction tool, carefully pry the chips out evenly on both sides. See Fig 18.
6. Install the new software chips. Make sure the chips are correctly located and orientated and all the pins are in the holes.
7. System Map Information is automatically updated and the transaction table is automatically cleared. Refer to the release notes sent with the software.

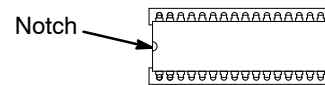

Fig. 16

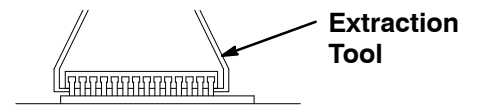
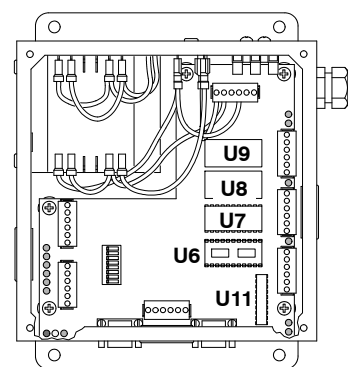

Fig. 17



Fig. 18



New Style Control Module

Fig. 19

Horizon System Components

Control Modules

Part No. 238624, Master Control Module

Part No. 238625, Slave Control Module

The Horizon system consists of a number of control modules that are connected by cables to form a network. The control modules provide the operating intelligence for the system. There are two types of control modules:

- the **Master Control Module** and
- the **Slave Control Module**.

Both types of control modules perform similar functions. They drive air and fluid solenoids and count pulses from meters. They have on-board memory that contains a map of all available system resources and a power supply that can be configured for either 110 or 220 VAC operation.

Master Control Module

The Master Control Module has several unique features:

- It has additional memory to hold data for completed dispense jobs.

- It controls activity over the CAN (Controller Area Network), which is the network that interconnects the control modules in a larger system.
- It provides the printer and/or computer interface.
- It continuously tracks the time and date.

Control Module Specifications:

- There can be a total of 40 control modules in a system, 1 Master plus 39 Slaves. There must be only one Master Control Module per system. Any additional control modules are Slave Control Modules.
- Each control module (Master or Slave) can support up to 6 solenoids, either air or fluid type.
- Each Control Module can support up to 6 pulse meters.
- The Master Control Module requires the use of the System Administrator Keypad to enter or change setup information or to run diagnostics.
- The control modules can be located any distance apart, provided that the total length of cable from one end of the network to the other end is no more than 2000 ft. (610 m) long.
- The Master Control Module can be located anywhere in the network, but because of its output port (for printer or computer), it should be near the shop office or printer/computer location.

Horizon System Components

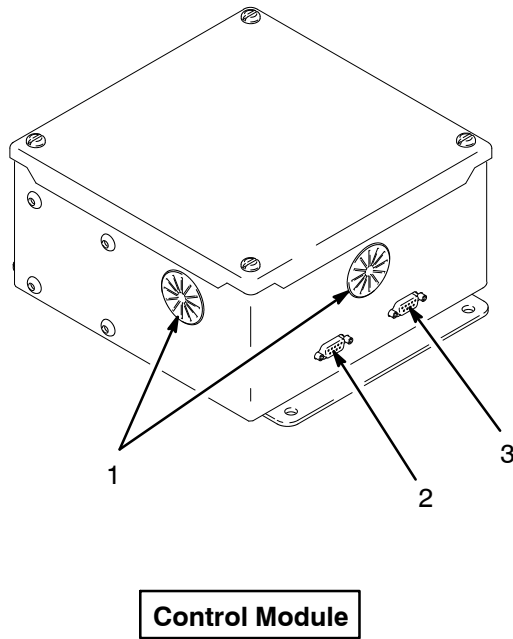

Control Module

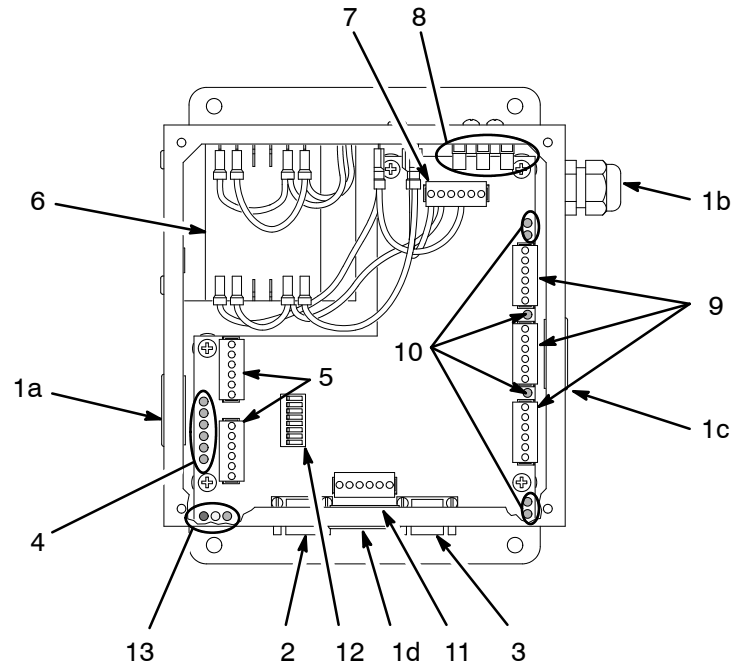

06799

Control Module Component Identification

NOTE: See page 78 for more information about system cables.

1. Cable Port Holes
 - a. Solenoid Cable Port Hole
 - b. AC Power Port Strain Relief
 - c. Pulse Meter Cable Port Hole
 - d. CAN Cable Port Hole
2. Keypad Cable Connector
Use to connect a keypad cable
3. Printer/Computer Connector
Used only on the Master Control Module to connect a serial cable from a printer or computer
4. Solenoid Diagnostic LEDs
Indicate whether solenoid drivers are turned on
5. Solenoid Cable Connectors
Use to connect solenoid cable wires to the control module
6. Power Supply
Converts AC input power for use by control module
7. Power Supply Connector
Connects internal power supply to the electrical power source
8. Electrical Power Cable Connector
Use to connect AC input electrical power cable wires to the control module
9. Meter Cable Connectors
Use to connect pulse meter cable wires to the control module
10. Pulse Meter Diagnostic LEDs
Indicate whether pulse meters are operating properly
11. Network Cable Connector
Use to connect network cable wires from other control modules
12. DIP Switches
Use to set the control module address
13. Network Diagnostic LEDs
Indicates whether the control module network is operating properly

Horizon System Components

Keypads

Part No. 113551, Basic Keypad

Part No. 113552, Enhanced Keypad with Bar Code Reader Part No. 113642,

Part No 113553, Administrative Keypad,

Keypads are the interface to the system. They are used to:

- request dispense jobs,
- configure the system,
- monitor system activities,
- and check and update fluid inventories.

There are three types of keypads, each with a distinct purpose.

Basic Keypad

The Basic Keypad is the model most used with a system. It has a set of large numeric keys and the additional keys needed to navigate through the Horizon's menus (up and down arrows, HOME and BACK, and the ENTER keys).

All run and inventory functions of the system can be accessed with this keypad. However, information that requires the entry of letters cannot be input with this keypad. Operator PIN (personal identification number) numbers must contain only numbers. If the operator is required to input data to the Job Number, Vehicle ID or custom-input fields, only numbers can be input.

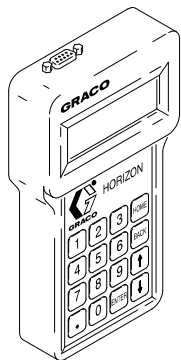

Basic Keypad

06518

Enhanced Keypad with Bar Code Reader

The Enhanced Keypad provides all the functionality of the Basic Keypad, with the added functionality of a bar code reader.

The bar code reader can input data into three optional data fields:

1. Job Number field,
2. Vehicle ID field and
3. Custom-input field (user can choose what to name and record in this field).

Each of the three fields accepts up to seven characters input. If the bar code reader reads in more than seven characters, the characters will wrap in the field, overwriting earlier characters.

The bar code reader can also be used with the Administrative Keypad.

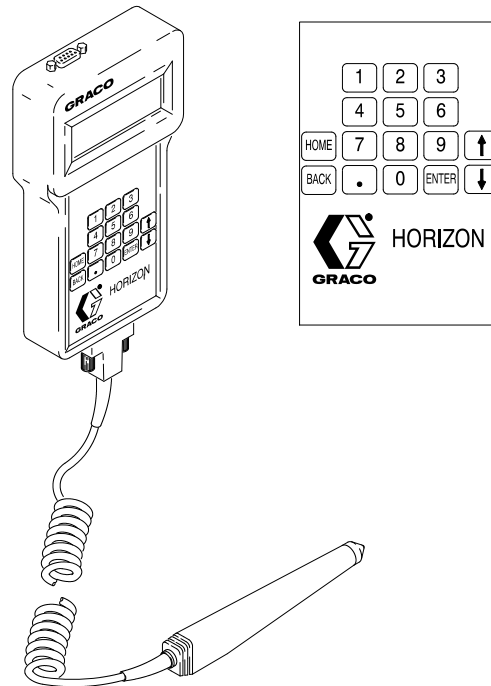

Enhanced Keypad with Bar Code Reader

06519

Horizon System Components

Administrative Keypad

This keypad is needed to set up and make changes to the system parameters. It can only be connected to the Master Control Module.

The Administrative Keypad features a complete alphabetic keypad in addition to the numbers and navigation keys of the other two keypads. This enables it to input the labels for fluids, dispense areas, operator names and other setup data.

With its full, complex set of keys, it is not intended for everyday use in requesting dispense jobs, although it can accomplish those tasks. It can also support the attachment of a bar code reader.

The Administrative Keypad can be kept in the shop foreman's office (or similar location), where it can be used for occasional system configuration changes. Another option is for the distributor or installer to keep this keypad to maintain multiple installations.

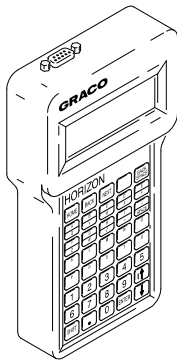

Administrative Keypad

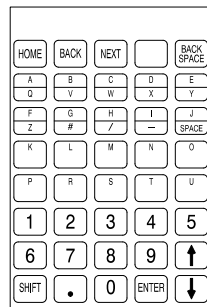

06520

Keypad Specifications:

- There can only be one Administrative Keypad in the system, and it can only be connected to the Master Control Module.
- There is only one port for connecting keypads to a Control Module, therefore, there can only be as many keypads in a system as there are control modules.
- The entire system (regardless of size) can be controlled from just one keypad or from multiple keypads located out on the shop floor.
- All of the keypads are connected to the Control Modules by 25 or 50 ft. (7.6 or 15.3 m) 22 AWG cables.
- The bar-code reader can only be connected to the Enhanced and Administrative keypads.
- There is a wall-mount bracket accessory available that will accept any of the keypads.

Keypad Wall-mount Bracket

Part No. 191368

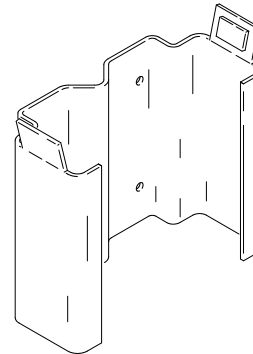

Keypad Bracket

Horizon System Components

Fluid Solenoid Valves

Part No. 218588, Fluid Solenoid Valve

0 to 3 gpm (0–11.4 liter/min.), with Ready Light; See manual 307696 for more information

Part No. 215487, Fluid Solenoid Valve

0 to 3 gpm (0–11.4 liter/min.), without Ready Light; See manual 307696 for more information

Part No. 512927, Fluid Solenoid Valve

0 to 6 gpm (0–22.7 liter/min.), without Ready Light

Part No. 238996, Ready Light Kit

Technical Data

Category	Data
Type	2 way, normally closed
Electrical Rating	28 V DC, 0.46 amp NOTE: provides minimum current draw when operated at 24 V DC
Coil Insulation	Class H
Leads	18 AWG x 18.0 in. (457 mm) long
Maximum Working Pressure	3000 psi (21 MPa, 207 bar)
Inlet/Outlet	1/2 npt
Minimum Actuation Volts Required	20
Wiring Gauge Required (by cable length)	18 AWG up to 50 ft. (15.3 m)

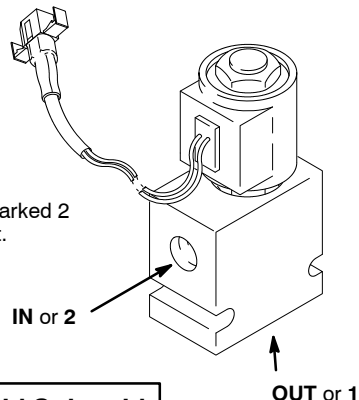

NOTE: Part No. 512927 is marked 2 at the inlet and 1 at the outlet.

Fluid Solenoid

Air Solenoid Valves

Part No. 215407, Air Solenoid Valve; Low Flow

For low-air-flow requirement pump models, such as the Eagle™ and Fire-Ball®

Part No. 512926, Air Solenoid Valve; High Flow

For higher-flow pump models, such as the President®

Technical Data

Category	Data
Type	3 way solenoid operated air valve, normally closed
Electrical Rating	24 V DC, 0.25 amps
Coil Insulation	General purpose, Class A Encapsulated, Continuous Duty
Leads	18 AWG x 12.0 in. (305 mm) long
Inlet/Outlet Part No. 215407 Part No. 512926	Adapted to 3/8 npt 3/8 npt
Wiring Gauge Required (by cable length)	18 AWG up to 50 ft. (15.3 m)

Part No. 215407 shown

NOTE: Part No. 512926 uses the same number indicators for the inlet, outlet, and exhaust.

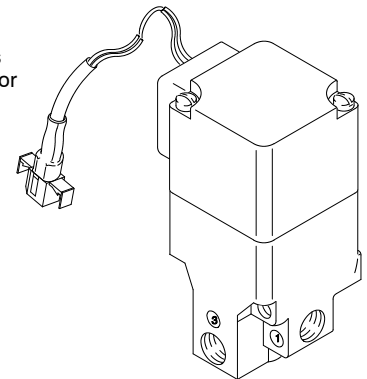
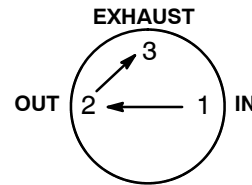

Air Solenoid

Fluid and Air Solenoids

Solenoids are electrically operated by the control module they are connected to. The fluid solenoids start and stop the fluid dispense cycles. The air solenoids open and close the air supply to the pump.

Solenoid Specifications:

- Up to 6 solenoids can be connected to each control module.
- A fluid solenoid must be placed at each dispense point for each fluid being dispensed.
- The use of air solenoids to turn off pressure to the pumps when a fluid is not being dispensed is strongly recommended. Standard thermal/pressure relief design practices should be followed also.

Horizon System Components

Pulse Meters

Part No. 238618, Pulse Meter

For oil, ATF, or gear lube. Measures in pints, quarts, or gallons. Sends 200 pulses per quart (211 pulses per liter) of fluid through it. Includes the following replacement part:

Ref. No.	Part No.	Description	Qty.
1	239367	ELECTRONIC PULSE MODULE	1

Part No. 215474, Pulse Meter

For washer fluid, antifreeze, water, or oil. Measures in pints, quarts, or gallons. Sends 10 pulses per quart (11 pulses per liter) of fluid through it.

Pulse Meter

Part No. 238618 shown

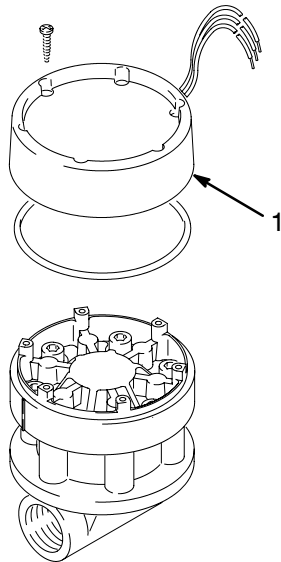

Pulse Meter Technical Data

Category	Data
Electrical Input Voltage	15 V Maximum
Signal Output	0 V OFF 15 V maximum ON
Maximum Fluid Flow	12 gpm (45.6 liter/min.)
Maximum Operating Pressure	1500 psi (10.3 MPa, 103 bar)
Inlet/Outlet	1/2 npt
Wiring Gauge Required	18 AWG up to 50 ft. (15.3 m)

Pulse Meters

The pulse meters measure fluid flow to dispense points and send a series of pulses back to the control modules. The control modules count these pulses to determine how much fluid has been dispensed.

The electronic portion of part no. 238618, pulse meter for oils, ATF, and gear lube is available; see at left. The Electronic Fluid Commander meter, part no. 236763, is not directly compatible with the Horizon system. Replace the electronic pulse module with part no. 239367.

If an antifreeze/washer pulse meter is already part of an installation (probably connected to a Modular Fluid Commander), it can interface directly with the Horizon with the addition of a resistor/capacitor network to the cable to ensure proper reading of the pulses.

During the setup of the Horizon software, each pulse meter is defined, including the number of pulses per unit of fluid. This pulse constant can be input for different units of fluid measure, and can also be used to fine-tune the accuracy of the measurement.

The number of pulse meters in a system is the key to supporting simultaneous dispensing of fluids.

- With one pulse meter in the line of each fluid being controlled and monitored (which is the minimum requirement), the Horizon will support one reel dispensing each of the fluids at a given time. The groups of reels that share a pulse meter are referred to as *Fluid Zones*.
- If more than one reel of a given fluid must be able to dispense simultaneously, additional pulse meters must be installed in that fluid's plumbing.
- If all reels for a fluid must be able to dispense at the same time, a meter must be installed at each reel to measure the fluid dispensed there. To support simultaneous dispensing to many areas, the fluid system (particularly the pump) must be sized properly.

For more information on setting up fluid zones, simultaneous dispensing, and placing pulse meters in the system, see **System Configuration**, page 83.

Pulse Meter Specifications:

- Up to 6 pulse meters can be connected to each control module.
- If there is one pulse meter per fluid, it should be located near the pump.
- If there are multiple meters for a single fluid, check valves should be placed in series with each meter to prevent false counting of pulses due to pulsation (see page 106).
- The pulse meter for a dispense point does not have to be connected to the same control module as the air or fluid solenoids used to control that dispense point.

Horizon System Components

System Cables

For Keypad or Printer Connections (include connectors)

Part No.	For	Length
191393	Keypad or Printer (new style)	25 ft. (7.6 m)
191394	Keypad or Printer (new style)	50 ft. (15.3 m)
191395	Printer (old style)	25 ft. (7.6 m)
191396	Printer (old style)	50 ft. (15.3 m)

For Computer Connections (include connectors)

Part No.	For	Length
192873	Computer I/O	25 ft. (7.6 m)
192874	Computer I/O	50 ft. (15.3 m)

For Meter, Solenoid, or Network Connections (bulk cable)

Part No.	For	Description	Length
113555	Pulse Meter	3 conductors, shielded	500 ft. (152.5 m)
113556	Pulse Meter	3 conductors, shielded	1000 ft. (305 m)
113557	Solenoid	2 conductors, unshielded	500 ft. (152.5 m)
113558	Solenoid	2 conductors, unshielded	1000 ft. (305 m)
113559	Network	2 conductors, shielded	500 ft. (152.5 m)
113560	Network	2 conductors, shielded	1000 ft. (305 m)

Belden Bulk Cable Part Nos.

Order length needed

Part No.	For
8770	Pulse Meter
9740	Solenoid
8761	Network

Keypad Cables (with connector)

These cables connect keypads to control modules.

They are available in 25 and 50 ft. (7.6 and 15.3 m) lengths, with 9-pin RS-232 connectors. *Keypads can be no further than 50 ft. (15.3 m) from the control module.*

Computer Cables (with connector)

These cables connect the Horizon output port to a computer serial connector for data transfer.

They are available in 25 and 50 ft. (7.6 and 15.3 m) lengths, with 9-pin RS-232 connectors. *Computers can be no further than 50 ft. (15.3 m) from the control module.*

Printer Cables (with connector)

These cables connect the printer to the Master Control Module. They are available in 25 and 50 ft. (7.6 and 15.3 m) lengths, with 9-pin RS-232 connectors. These cables are not interchangeable with the computer cables as the pin assignments are different. *The printer can be no further than 50 ft. (15.3 m) from the Master Control Module.*

NOTE: Part no. 191395 and 191396 are for the old-style printer 113774 only. See the printer drawing on page 80.

Pulse Meter Cables (bulk)

These cables connect the pulse meters to the control modules. They are 3-conductor, 18 AWG shielded cables and are available in bulk spools of 500 or 1000 ft. (152.5 or 305 m). *Pulse meters can be no further than 50 ft. (15.3 m) from a control module.*

Horizon System Components

Solenoid Cable (bulk)

These cables connect the air and fluid solenoids to the control modules. They are 2-conductor, 18 AWG unshielded cables and are available in bulk spools of 500 or 1000 ft. (152.5 or 305 m). *Solenoids can be no further than 50 ft. (15.3 m) from a control module.*

Network Cable (bulk)

Control modules are linked together with 2-conductor, 22 AWG shielded cable, which is available in bulk spools of 500 or 1000 ft. (152.5 or 305 m). *There is no distance requirement between control modules, provided the overall length of the network is not greater than 2000 ft. (610 m).*

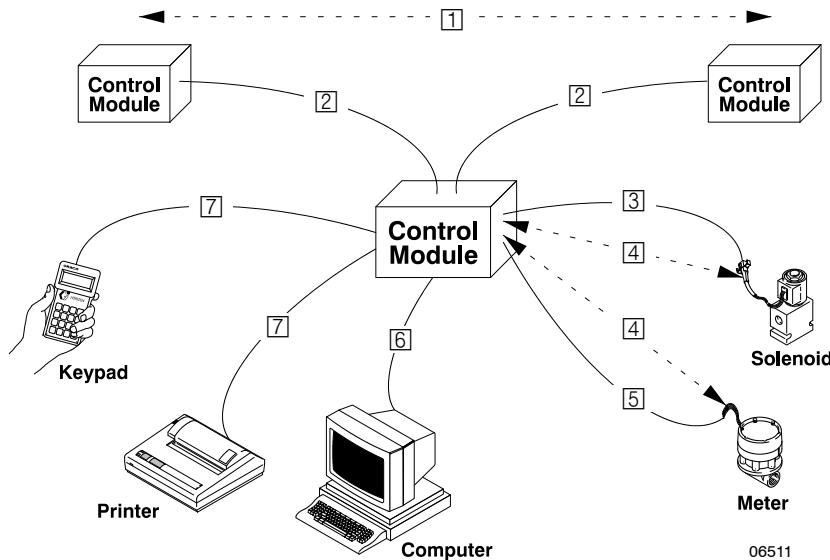

Cables

- 1 2000 ft. (610 m) maximum total network length
- 2 Bulk Cable, P/N 113559 [500 ft. (152.5 m)] or 113560 [1000 ft. (305 m)]
- 3 Bulk Cable, P/N 113557 [500 ft. (152.5 m)] or 113558 [1000 ft. (305 m)]
- 4 50 ft. (15.3 m) maximum total length
- 5 Bulk Cable, P/N 113555 [500 ft. (152.5 m)] or 113556 [1000 ft. (305 m)]
- 6 Cable with connector, P/N 192873 [25 ft. (7.6 m)] or 192874 [50 ft. (15.3 m)]
- 7 Cable with connector, P/N 191393 [25 ft. (7.6 m)] or 191394 [50 ft. (15.3 m)]

06511

Horizon System Components

Pressure Relief Kit

Part No. 207221, Pressure Relief Kit

900 psi (6.2 MPa, 62 bar) Maximum Working Pressure

For installation at the pump; see page 104. Relieves fluid line pressure when the pressure exceeds 900 psi (6.2 MPa, 62 bar).

NOTE: Order **Part No. 102527 Pressure Relief Valve** for installation at the check valve to vent thermal expansion pressure. See page 106.

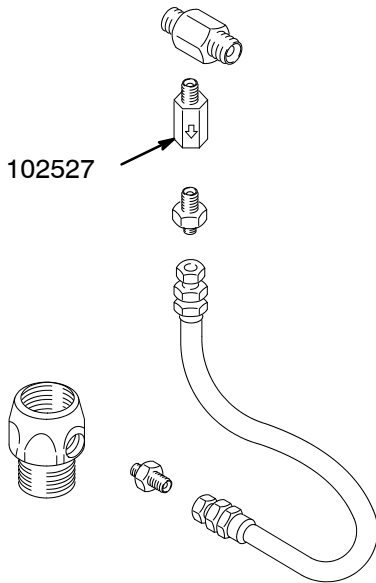

Pressure/Thermal Relief Kit

40 Column Thermal Printer

Part No. 113774, Thermal Printer

Order power supply and paper separately. See below.

Part No. 514037, Printer Paper

Printer Replacement Paper, 1 roll

Printer Power Supply

Part No.	Description
114442	120 VAC
114443	230 VAC
114444	100 VAC

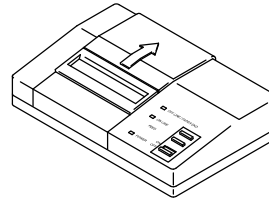

Old Style Printer

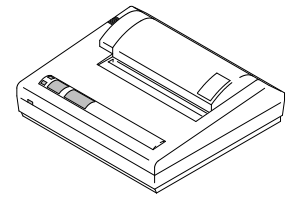

New Style Printer

Printer

The Horizon system printer can print out individual job tickets after each dispense transaction is completed. It uses a roll of thermal paper and prints a 40-column-width ticket, similar to a cash register receipt. These dispense reports can be torn off immediately (for attachment to an invoice, for instance) or saved for later analysis. The printer is connected to the Master Control Module by a 25 or 50 ft. (7.6 or 15.3 m) 22 AWG shielded cable. See page 78.

01326

Fluid Check Valve

Part No. 111620, Check Valve

1500 psi (10.3 MPa, 103 bar) Maximum Working Pressure

1/2 npt(fbe), Not Shown

Appendix

Horizon Software Features

The system is operated by responding to menus displayed on the keypad screen. The operator can select a fluid and its destination reel, enter the amount to dispense, input optional data such as a work order number or vehicle ID, verify that the entry is correct prior to starting the dispense, and review any active jobs or jobs that are waiting in queue.

Fluids and dispense areas can be selected by number or by name, to eliminate the need to memorize numbers for fluids or locations.

Setup

In order to make the operator screens easy to use, detailed information must be entered during setup. This information includes all the labels for fluids, dispense areas and control modules; assignment of solenoids and meters to ports on the control modules; and calibration factors for each meter in the system.

Levels of Access

If desired, a PIN (personal identification number) can be assigned during setup to each person who will use the system. The PIN is entered by the user each time the system is accessed and prevents unauthorized use.

Each user name and PIN can be given different levels of system access. There are three system access levels:

1. **Run** – allows the user to dispense fluids only
2. **Inventory** – allows the user all run capabilities, plus access to inventory monitoring
3. **Setup** – allows access to run and inventory, plus all system setup, maintenance, and diagnostic functions

In a typical shop, the operators may have Run access only, the shop manager may have Inventory access, and the system administrator or installer may have Setup access.

Additional security can be configured into the system, by assigning the person with Setup access a PIN that includes alphabetic characters. This would require the person to have access to the Administrators Keypad in order to use the setup and diagnostic screens.

Fluid Supply Monitoring

The Inventory setup allows the user to monitor the level of each tank on the system. A level can be set at which the operator will be warned to refill the tank. It is important that each time a tank is filled, the amount added be entered into the Horizon system; there is no *physical* tank-level-monitoring device. The user can also view how much fluid has been used over a given period of time and can print out the inventory levels of the fluid tanks.

Information Output

The user can choose to have dispense transaction records and inventory reports sent to a printer or a computer that is connected to the Horizon system.

If the printing option is chosen, the user can print each dispense record out immediately after it is completed or print the records on demand. Each printout will have the date and time on it.

System Diagnostics

The system diagnostics are accessible only to the person with Setup access. From these screens, the user can turn solenoids on and off manually, count meter pulses from a specified meter, determine if all control modules are talking across the network, print setup information, and check the number of times the system has been powered on and off. These features are useful to the installer during setup time, as well as when troubleshooting a version level or testing transaction reports.

The system configuration and the completed transaction records are stored in non-volatile memory to ensure that no vital information is lost during a power failure.

Setup Modification

The user can erase a single section or all of the system configuration map. This is useful if the facility is being modified or the Horizon system is being transferred to a new location. It is recommended that the entire setup be cleared prior to setting up the system for the first time to ensure that there is no information remaining from factory testing.

System Configuration

Installation Considerations

The Horizon system must be wired by an electrician and the installation must comply with local licensing and electrical codes.

The Horizon Control Modules are designed to be hard-wired into the facility's electrical system. It is recommended that the system be placed on a separate circuit breaker. This will help prevent accidental shut-down of the system and make it easier to power off the system when necessary. The system is designed to remain powered-up continuously during normal operation.

The system software setup procedures do not require a familiarity with computers or PC software. All configuration is completed by answering prompts on the keypad screen.

Steps For Configuring A System

NOTE:

- Pages 84 to 96 show examples of system design and how to complete and use the Horizon Forms to setup the system.
- See pages 72 to 80 for Horizon system component information.
- See pages 104 to 106 for system design factors to consider.
- Technical Data is on page 107.

System Requirements

1. Determine the requirements. This includes such information as which fluids are to be controlled and monitored and how many bays, reel banks, and drops the system will have.

Floor Plan

2. Lay out the floor plan of the shop. While the floor plan does not have to be extremely detailed, it should be reasonably accurate. The floor plan will be used to position Horizon components, many of which are sensitive to cable lengths.

NOTE: See the Technical Data on page 107 for the system specifications.

3. Place the fluid system components (pumps and reels) on the floor plan in their proper location.
4. Lay out the piping for each fluid. At this point it is important to consider the requirements for simultaneous dispensing. If simultaneous dispensing is required, the piping must be designed in fluid zones that will have multiple meters.
5. Place the air solenoids at the pump inputs, the fluid solenoids at each controlled dispense point, and the pulse meters at the T-branch for each fluid zone, for each fluid.
6. Place the control modules on the floor plan. Each control module can connect up to 6 solenoids and 6 meters, all of which can be no more than 50 ft. (15.3 m) *total wire length* from the control module. Vertical distance, routing around pipes and beams, and other factors must be considered. For this reason, it is best to place the control modules near the reels.
7. Place the keypads and printer or computer on the floor plan. The cables to these devices are limited to 25 or 50 ft. (7.6 or 15.3 m).

System Design Suggestions

- Place solenoids and meters close together to take advantage of the control module ports.
- Keep all bulk cable lengths as short as possible.
- Take into account vertical cable runs when laying out a system.
- Use the shorter, 25 ft. (7.6 m) cable for the keypads, printer, or computer if possible,
- Place the Master Control Module nearest to where the printer or computer will be located.

System Configuration

System Configuration Examples

Example 1 Configuration

- 3 fluids
- All 3 fluids dispensed in each of 3 bays
- No simultaneous dispensing of the same fluid
- One keypad in the office
- Printer in the office for output

The Example 1 Parts List is the minimum needed to support the Example 1 Configuration. If the dimensions of the facility are too large, the 50 ft. (15.3 m) maximum for cables may require the installation of additional control modules.

Example 1 Parts List

Qty.	Component
1	Master Control Module
1	Slave Control Module
1	Keypad (could be Administrator Keypad for setup, or Basic Keypad for normal operation)
3	Air Solenoids
9	Fluid Solenoids
3	Pulse Meters
1	Printer
1	Printer Cable, 25 or 50 ft. (7.6 or 15.3 m)
1	Keypad Cable, 25 or 50 ft. (7.6 or 15.3 m)
1	Solenoid Cable, bulk spool
1	Meter Cable, bulk spool
1	Network Cable, bulk spool

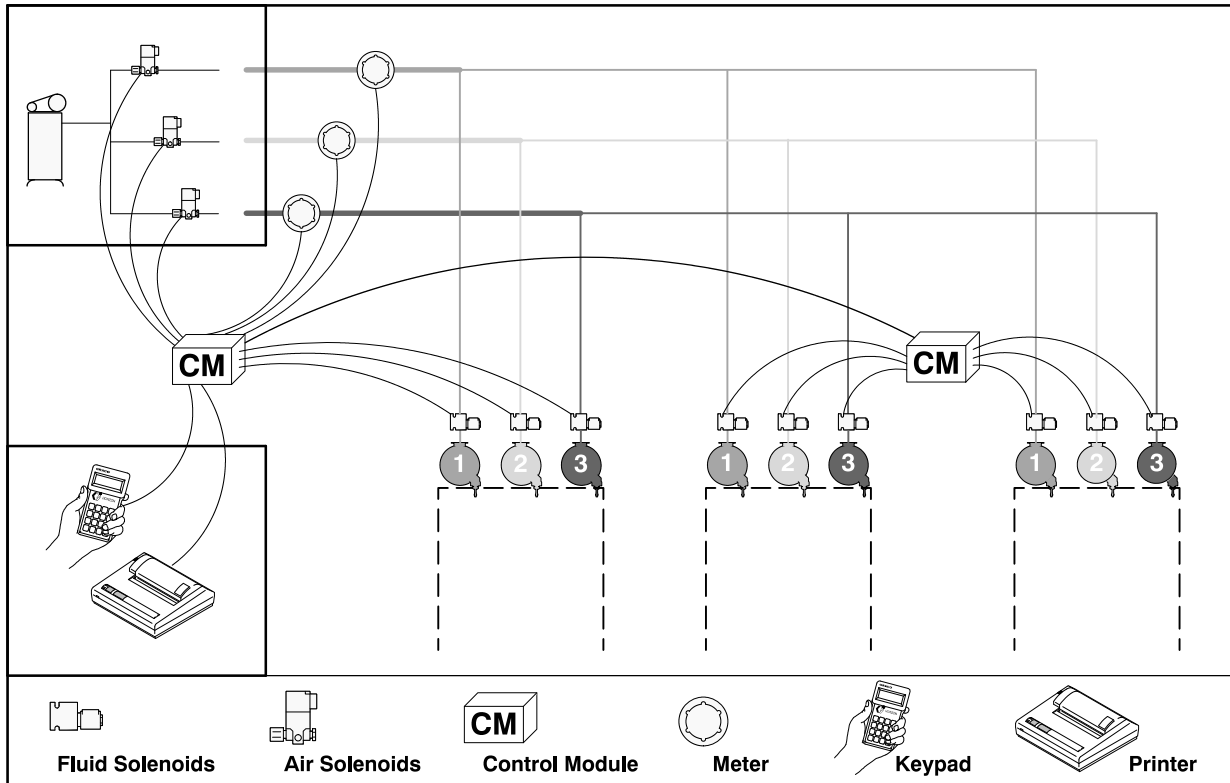

Example 1

06512A

System Configuration

Example 2 Configuration

- 3 fluids
- All 3 fluids dispensed in each of 3 bays
- Simultaneous dispensing of all fluids to all bays
- One keypad in the office, plus a keypad in each bay
- Printer in the office for output

The Example 2 Parts List is the minimum needed to support the Example 2 Configuration. The requirement for a keypad in each bay forces the inclusion of additional control modules. The total of 12 solenoids and 9 meters could be handled by 2 control modules (6 ports on each for solenoids and six ports on each for meters), but each control module has only one port for attaching a keypad.

Example 2 Parts List

Qty.	Component
1	Master Control Module
3	Slave Control Module
4	Keypads (could be 1 Administrator Keypad for setup and 3 Basic Keypads for the bays)
3	Air Solenoids
9	Fluid Solenoids
9	Pulse Meters
1	Printer
1	Printer Cable, 25 or 50 ft. (7.6 or 15.3 m)
4	Keypad Cable, 25 or 50 ft. (7.6 or 15.3 m)
1	Solenoid Cable, bulk spool
1	Meter Cable, bulk spool
1	Network Cable, bulk spool

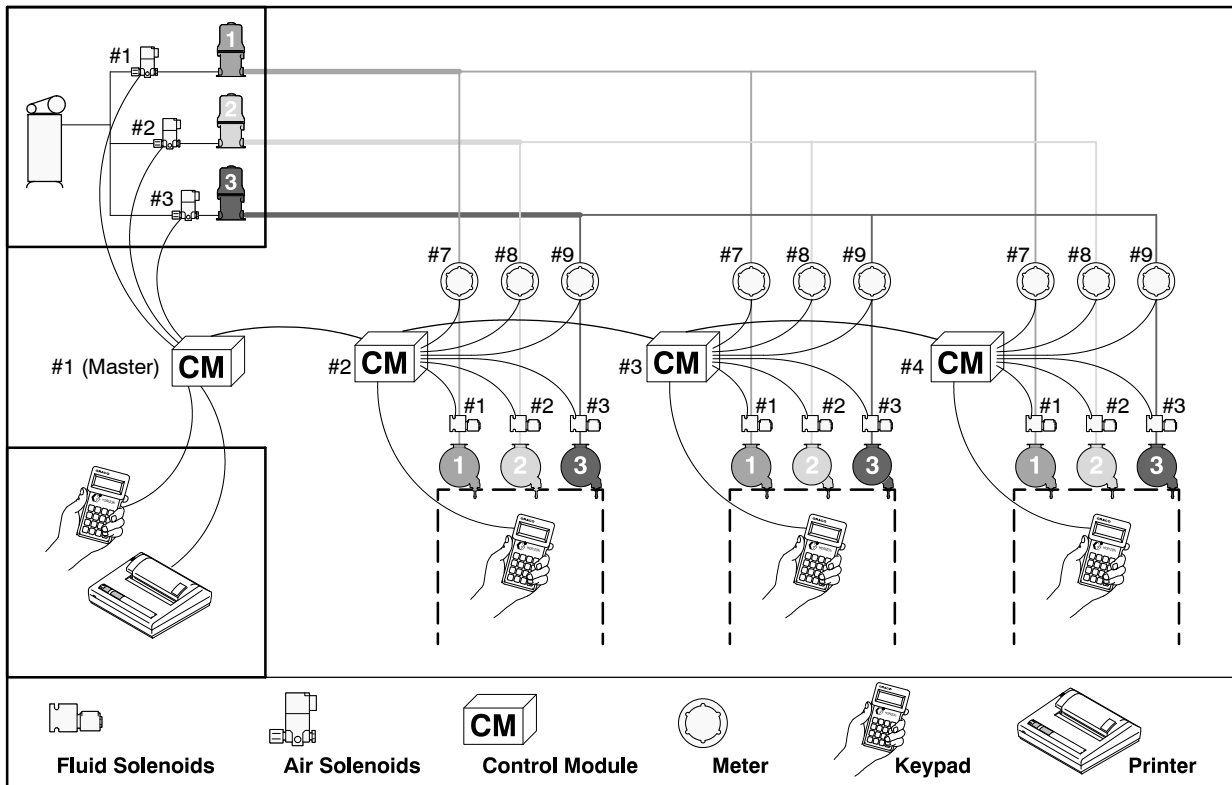

Example 2

06513A

Horizon Form #1

The following **Horizon Form** pages show examples of how to complete and use the forms to setup the system. The example forms are filled out according to the system design shown on page 85 and are based on the flow of screens in a NEW SETUP.

Use Form #1 as a guide for inputting the operator names and PIN numbers or passwords. The OPERATOR PASSWORD screen will appear after accessing: SETUP→NEW SETUP.

Set Operator Access Information

1. Type the 4-character name in the NAME field and press ENTER on the keypad.
2. Type the 4-digit password or PIN and press ENTER.
Remember that the Basic Keypad only has number keys.
3. Use the ↓ or ↑ keys to scroll the access levels to RUN, INVNT (inventory level, which also gives access to run level), and SETUP (which gives access to all levels). Press the ENTER key when the proper access level is displayed.
4. After entering the access level, the cursor will move to ADD on the bottom line. If there are more names to add, press ENTER and repeat steps 1 to 3. If all the operator names have been entered, use the ↓ or ↑ keys to move the cursor to EXIT and press ENTER.

NOTE: Use the ↓ or ↑ keys to move the cursor to DELETE if you need to delete operator entrees.

5. After EXIT is entered, the SAVE SETUP verification screen will appear.
6. Scroll to YES by pressing the ↓ or ↑ key.
7. Press ENTER on the keypad to save the Operator Access information and go to the CONTROL MODULE screens, shown on page 89.

OPERATOR PASSWORD Screen

NAME:	█	----	
PASSWORD:		----	
ACCESS:		RUN	↓ or ↑
	ADD	EXIT	DELETE

NAME:	JOHN		
PASSWORD:	1234		
ACCESS:		RUN	↓ or ↑
█	ADD	EXIT	DELETE

SAVE SETUP Verification Screen

SAVE SETUP:	▶	█	YES	↑ ↓
WARNING:				
SAVE WILL CANCEL				
ACTIVE/WAITING JOBS				

Horizon Form #2



Graco, Inc.

Horizon

Control Module & Fluid Names & Numbers



Control Module Location	CM #	CM Name in Software Map (10 Characters max)										
Master - Near Office/Pumps	1	O	F	F	I	C	E					
At Service Bay #1	2	B	A	Y		1						
At Service Bay #2	3	B	A	Y		2						
At Service Bay #3	4	B	A	Y		3						
	5											
	6											
	7											
	8											
	9											
	10											
	11											
	12											
	13											
	14											
	15											
	16											
	17											
Fluid Name	Units	Fluid #	Fluid Name in Software Map (10 Characters max)									
5/30 Motor Oil	Qts	1	5	/	3	0		0	I	L		
10/30 Motor Oil	Qts	2	1	0	/	3	0		O	I	L	
Automatic Trans. Fluid	Pts	3	A	T	F							
		4										
		5										
		6										
		7										
		8										
		9										
		10										

Horizon Form #2

Use Form #2 as a guide for inputting the control module and fluid names.

Name the Master Control Module

NOTE: The first screen you access will be the Master Control Module screen CM#01. The Cursor will be in the name field as the Master Control Module number is always #01. The other difference in the Master Control Module screen is that there is no DELETE option.

1. Type the name for the control module. The name can be up to 10 characters and should describe the location of the control module to ease operation.
2. Press ENTER on the keypad to input the name and move the cursor to the bottom line.
3. The cursor will be at ADD. If there are more control module names to add, press ENTER. If all the control module names have been entered, go to Step 7.

Name Slave Control Modules

4. The cursor will be in the CM# field. The control module number will automatically increment up by 1 as you add modules or you can type the number manually.

NOTE: The control module number must correspond with the numbers setup on the control module DIP switch.

5. Press ENTER on the keypad to move the cursor to the NAME field.
6. Follow Steps 1 to 3 until all the control module names have been entered.
7. When all the control module names have been entered, use the ↓ or ↑ keys to move the cursor to EXIT and press ENTER.

NOTE: Use the ↓ or ↑ keys to move the cursor to DELETE if you need to delete control module entries.

8. After EXIT is entered, the SAVE SETUP verification screen will appear.
9. Scroll to YES by pressing the ↓ or ↑ key.
10. Press ENTER on the keypad to save the setup options and go to the FLUID DATA screen.

Enter Fluid Data

1. The cursor will be in the fluid number (FL01) field. The fluid number will automatically increment up by 1 as you add fluids or you can type the number manually.
2. Press ENTER on the keypad to move the cursor to the NAME field.
3. Type the name of the fluid (up to 10 characters) and press ENTER.

MASTER CONTROL MODULE Screen

```
NAME CONTROL MODULES
  CM#01 (MASTER CM)
NAME: OFFICE █ _ _ _ _
  ADD                               EXIT
```

SLAVE CONTROL MODULE Screen

```
NAME CONTROL MODULES
  CM#02 (SLAVE CM)
NAME: BAY 1 █ _ _ _ _
  ADD                               EXIT   DELETE
```

SAVE SETUP Verification Screen

```
SAVE SETUP: ► YES      ↑ ↓
WARNING:
SAVE WILL CANCEL
ACTIVE/WAITING JOBS
```

FLUID DATA Screen

```
FLO1 NAME: 5/30 OIL █ _
UNITS: QUARTS           ↓ ↑
ORDER: 01
  ADD                   EXIT   DELETE
```

4. The cursor moves to the UNITS field. Scroll through the available units of measurement by pressing the ↓ or ↑ key, and stop at the value needed, then press ENTER.

NOTE: There are four units of measurement available: quarts, liters, gallons, and pints. The unit has to be set individually for each fluid.

5. The cursor moves to the ORDER number field. The order number determines the order that fluids are displayed during RUN operations. The default setting is to display the fluids in the order of the fluid numbers.
6. Type in the order number if it is different than the number displayed.

NOTE: It is recommended that the ORDER number not be changed during the initial setup.

7. Press ENTER to move to the bottom line. The cursor will be at ADD. If there are more fluids to add, press ENTER.
8. When all the fluids have been entered, use the ↓ or ↑ keys to move the cursor to EXIT and press ENTER.

NOTE: Use the ↓ or ↑ keys to move the cursor to DELETE if you need to delete fluid entries.

9. After EXIT is entered, the SAVE SETUP verification screen will appear.
10. Scroll to YES by pressing the ↓ or ↑ key.
11. Press ENTER on the keypad to save the setup options and go to the DISPENSE AREA screen.

Horizon Form #3



Graco, Inc.

Horizon



Dispense Area Names & Numbers

Dispense Area Location	DA #	Dispense Area Name in Software Map (10 Characters max)									
Service Bay #1	1	B	A	Y		1					
Service Bay #2	2	B	A	Y		2					
Service Bay #3	3	B	A	Y		3					
	4										
	5										
	6										
	7										
	8										
	9										
	10										
	11										
	12										
	13										
	14										
	15										
	16										
	17										
	18										
	19										
	20										
	21										
	22										
	23										
	24										
	25										
	26										
	27										
	28										
	29										
	30										

Horizon Form #3

Use Form #3 as a guide for inputting the names of the dispense areas.

You also define which fluids are available at each dispense area while in the DISPENSE AREA screens. See Form #4 (next page) for that information.

Define Dispense Areas

1. The cursor will be in the dispense area number (DA01) field. The dispense area number will automatically increment up by 1 as you add areas or you can type the number manually.
2. Press ENTER on the keypad to move the cursor to the NAME field.
3. Type the name of the dispense area. The name can be up to 10 characters and should describe the location where fluids will be dispensed.
4. Press ENTER to input the name and move the cursor to the next field.

NOTE: The fluid numbers (in this example: 1, 2, and 3) will be displayed according to the number of fluids that were entered while in the FLUID DATA screens.

5. Leave the N if fluid 1 is not available at this dispense area. Scroll to Y by pressing the ↓ or ↑ key if the fluid is available at this dispense area.
6. Press ENTER on the keypad to ENTER the value and move to the next N.
7. After pressing ENTER for the last fluid, the cursor will move to ADD on the bottom line.

8. If there are more dispense areas to add, press ENTER.
9. When all the dispense areas have been entered, use the ↓ or ↑ keys to move the cursor to EXIT and press ENTER.

NOTE: Use the ↓ or ↑ keys to move the cursor to DELETE if you need to delete dispense area entries.

10. After EXIT is entered, the SAVE SETUP verification screen will appear.
11. Scroll to YES by pressing the ↓ or ↑ key.
12. Press ENTER on the keypad to save the setup options and go to the ASSIGN CONNECTIONS screen.

DISPENSE AREA Screen

```
DAO1 NAME: _ _ _ _ _
1 2 3
N N N
ADD          EXIT          DELETE
```

```
DAO1 NAME: BAY 1 _ _ _ _ _
1 2 3
Y Y Y N N Y
ADD          EXIT          DELETE
```

SAVE SETUP Verification Screen

```
SAVE SETUP: ► YES      ↑↓
WARNING:
SAVE WILL CANCEL
ACTIVE/WAITING JOBS
```

Horizon Form #4

Graco, Inc.			FLUIDS									
Connection Assignments Record the Control Module # and port # for each solenoid (ports 1-6); number each meter consecutively (1,2,...) Example: CM1/3			Name	Name	Name	Name	Name	Name	Name	Name	Name	Name
			5/30 Oil	10/30 Oil	ATF							
			1	2	3	4	5	6	7	8	9	10
D I S P E N S E A R E A S	1	Bay 1	Air Solenoid	CM1/1	CM1/2	CM1/3						
		Fluid Solenoid	CM2/1	CM2/2	CM2/3							
		Meter Number	1	2	3							
	2	Bay 2	Air Solenoid	CM1/1	CM1/2	CM1/3						
			Fluid Solenoid	CM3/1	CM3/2	CM3/3						
			Meter Number	4	5	6						
	3	Bay 3	Air Solenoid	CM1/1	CM1/2	CM1/3						
			Fluid Solenoid	CM4/1	CM4/2	CM4/3						
			Meter Number	7	8	9						
	4		Air Solenoid									
			Fluid Solenoid									
			Meter Number									
	5		Air Solenoid									
Fluid Solenoid												
Meter Number												
6		Air Solenoid										
		Fluid Solenoid										
		Meter Number										
7		Air Solenoid										
		Fluid Solenoid										
		Meter Number										
8		Air Solenoid										
		Fluid Solenoid										
		Meter Number										
9		Air Solenoid										
		Fluid Solenoid										
		Meter Number										
10		Air Solenoid										
		Fluid Solenoid										
		Meter Number										
11		Air Solenoid										
		Fluid Solenoid										
		Meter Number										
12		Air Solenoid										
		Fluid Solenoid										
		Meter Number										
13		Air Solenoid										
		Fluid Solenoid										
		Meter Number										

Horizon Form #4

Use Form #4 as a guide for inputting which solenoids to turn on and which meter counts the pulses when dispensing specified fluids at specified dispense points.

Assign Connections

NOTE:

- The combined designation of the dispense area and fluid number is called the **dispense point**.
- The dispense point [dispense area 1 (DA01) and fluid number 1 (FL01)] appears in the first row on the Assign Connection (ASSGN CONN) screen.
- An ASSGN CONN screen will appear for each dispense point that was entered when the information from Forms #2 and #3 was entered.
- Port numbers 1 to 6 are available for solenoids.

1. The cursor will be in the Air Solenoid: Control Module (AIR SOL: CM) field.
2. Type the number of the control module that controls the air solenoid for this dispense point. Take this information from Form #4. In this example the entry would be CM01, taken from **CM1/1** on the form.

NOTE: The air solenoid can be assigned a value of zero (CM00) if an air solenoid is not used at this dispense point.

3. Press ENTER on the keypad.
4. The cursor moves to the PORT field. In this example the entry would be PORT1, taken from CM1/1 on Form #4.
5. Type the port number and press ENTER on the keypad.
6. Cursor moves to the Fluid Solenoid: Control Module (FLD SOL: CM) field.
7. Type the number of the control module that controls the fluid solenoid for this dispense point. In this example the entry would be CM02, taken from **CM2/1** on the Form #4.
8. Press ENTER on the keypad.
9. The cursor moves to the PORT field. In this example the entry would be PORT1, taken from CM2/1 on Form #4.
10. Type the port number and press ENTER on the keypad.
11. Cursor moves to the Meter Number (MTR#) field.
12. Type the number of the meter for this dispense point, as shown on the floor plan. The meters should be assigned consecutive numbers, starting with number 1. The meters you enter will display (when calibrating the meter) in the order they were entered. The actual addresses for the meter will be entered on a later screen.

13. Press ENTER on the keypad.
14. When the cursor is at MORE, press ENTER to repeat the screen for each valid dispense point.
15. When all the connections for each dispense point have been assigned, use the ↓ or ↑ key to move the cursor to EXIT and press ENTER.

NOTE: If you enter MORE after all the data has been entered, the screen will scroll back to DA01 FL01. Use the arrow keys to move the cursor to EXIT.

16. After EXIT is entered, the SAVE SETUP verification screen will appear.
17. Scroll to YES by pressing the ↓ or ↑ key.
18. Press ENTER on the keypad to save the setup options and go to the METER CALIBRATION screen.

ASSIGN CONNECTION Screen for DA01 FL01

Air Solenoid Connection Assigned

```
ASSGN CONN: DA01 FL01
AIR SOL: CM 01  PORT1
FLD SOL: CM 01  PORT0
MTR#: 000  MORE  EXIT
```

Fluid Solenoid Connection Assigned

```
ASSGN CONN: DA01 FL01
AIR SOL: CM 01  PORT1
FLD SOL: CM 02  PORT1
MTR#: 000  MORE  EXIT
```

Meter Number Assigned

```
ASSGN CONN: DA01 FL01
AIR SOL: CM 01  PORT1
FLD SOL: CM 02  PORT1
MTR#: 001  MORE  EXIT
```

ASSIGN CONNECTION Screen for DA01 FL02



All Connections Assigned

```
ASSGN CONN: DA01 FL01
AIR SOL: CM 01  PORT2
FLD SOL: CM 02  PORT2
MTR#: 002  MORE  EXIT
```

SAVE SETUP Verification Screen

```
SAVE SETUP: ► YES  ↑ ↓
WARNING:
SAVE WILL CANCEL
ACTIVE/WAITING JOBS
```

Horizon Form #5

		Graco, Inc. Horizon Meter Calibration Chart				
No.	Location	Fluid	CM #	Port #	Pulses Per	Unit
1	Bay #1	5/30 Oil	2	7	200	QT
2	Bay #1	10/30 Oil	2	8	200	QT
3	Bay #1	ATF	2	9	100	PT
4	Bay #2	5/30 Oil	3	7	200	QT
5	Bay #2	10/30 Oil	3	8	200	QT
6	Bay #2	ATF	3	9	100	PT
7	Bay #3	5/30 Oil	4	7	200	QT
8	Bay #3	10/30 Oil	4	8	200	QT
9	Bay #3	ATF	4	9	100	PT
10						
11						
12						
13						
14						
15						
16						
17						
18						
19						
20						
21						
22						
23						
24						
25						
26						
27						
28						
29						
30						
31						
32						
33						
34						
35						
36						
37						
38						
39						
40						

NOTES:

- Meters are always attached to Control Module Ports 7 - 12
- Nominal constants: 200 pulses per qt for 238618 (oils)
 10 pulses per qt for 215474 (ww fl, antifreeze)

Horizon Form #5

Use Form #5 as a guide for inputting the meter connection address and to set the calibration (pulses per unit) for each meter.

NOTE: Port numbers 7 to 12 are available for meters.

Set Meter Calibration

1. The cursor will be in the METER NUMBER field. The system will scroll through each of the meters as they were numbered on the previous ASSGN CONN screens.
2. Press ENTER on the keypad to move the cursor to the CM# field.
3. Type the number of the control module that controls the meter for this dispense point. Take this information from Form #5. In this example the entry would be CM# 02.
4. Press ENTER on the keypad to move the cursor to the PORT# field.
5. Type the number of the port the meter is connected to. In this example the entry would be PORT# 07.
6. Press ENTER on the keypad to move the cursor to the PULSES PER *[unit]* field.
7. Type the number of pulses. In this example the entry would be 200. The units of measure appear on the screen as they were entered in the FLUIDS screens.
 - Only integers between 1 and 9999 will be accepted for the calibration factor.

- **If using P/N 238618 Meter** (for oil), set calibration at:
 - 100 pulses per pint,
 - 200 pulses per quart,
 - 800 pulses per gallon, or
 - 211 pulses per liter
- **If using P/N 215474 Meter** (for antifreeze and washer fluid), set calibration at:
 - 5 pulses per pint,
 - 10 pulses per quart,
 - 40 pulses per gallon, or
 - 11 pulses per liter
- Start with the nominal value and adjust the value as needed to increase accuracy. If the dispense is slightly less than requested, make the number of pulses slightly higher (as it requires more pulses to equal a higher amount). If the dispense is slightly higher than requested, make the number a little lower.

8. After inputting the calibration factor, press ENTER to move the cursor to MORE. Press ENTER to repeat the screen for each meter.

9. When all the connections for each dispense point have been assigned, use the ↓ or ↑ key to move the cursor to EXIT and press ENTER.

NOTE: If you enter MORE after all the data has been entered, the screen will scroll back to METER NUMBER : 001. Use the arrow keys to move the cursor to EXIT.

10. After EXIT is entered, the SAVE SETUP verification screen will appear.

11. Scroll to YES by pressing the ↓ or ↑ key.

12. Press ENTER on the keypad to save the setup options.

METER CALIBRATION Screen for Meter #1

```
METER NUMBER: 001
CM# 02      PORT# 07
0200  PULSES PER QT
  █ MORE    EXIT
```

SAVE SETUP Verification Screen

```
SAVE SETUP: ► YES  ↑↓
WARNING:
SAVE WILL CANCEL
ACTIVE/WAITING JOBS
```

Horizon Form #6

Horizon Fluid Management Systems Warranty Registration and Checkout Form

1. Site Identification

Customer Name: Bob's Service Garage
 Address: 123 Main Street
 City/State/Zip: Anytown, USA 12345
 Phone Number: (612) 555-1234
 Key Contact Name: Bob Anderson

2. Installer Identification

Company Name: Pumps 'R Us
 Address: 9876 Elm Street
 City/State/Zip: Anytown, USA 12345
 Phone Number: (612) 555-9876
 Key Contact Name: Joe Good

3. System Hardware Identification and Checkout

	<u># in System</u>	<u>Operation Verified?</u>
Master Control Module	<u>1</u>	<u>Y</u>
Slave Control Module(s)	<u>3</u>	<u>Y</u>
Administrative Keypad	<u>1</u>	<u>Y</u>
Enhanced Keypad/Barcode Reader	<u>0</u>	<u>N</u>
Basic Keypad	<u>3</u>	<u>Y</u>
Air Solenoids	<u>3</u>	<u>Y</u>
Fluid Solenoids	<u>9</u>	<u>Y</u>
Oil Pulse Meters	<u>9</u>	<u>Y</u>
AntiFreeze/WWF Pulse Meters	<u>0</u>	<u>N</u>

4. System Software Identification & Checkout

(check if/when completed)

Run Options Configured: Passwords Yes Output Options Configured: Printer Yes
 Job # Yes Computer Yes
 Vehicle ID Yes
 Optional Field Yes - Miles
 Presets? Yes

5. Attachments (MANDATORY!)

(check when attached)

Yes Copies of all System Design Forms
Yes Copy of system map/floor plan
Yes Printout of Software Setup

6. Installer Signoff

I certify that I have checked out all system components and functions, and that they operate according to system design specs and customer expectations.

Installer Name: Joe Good
 Company: Pumps 'R Us
 Date Completed: 10/10/96

7. Customer Signoff

I agree that the system has been installed to my expectations and that I have been informed as to proper system operation. I accept control of the system.

Customer Name: Bob Anderson
 Company: Bob's Service Garage
 Date Completed: 10/10/96

Blank Forms

Horizon Form #2



Graco, Inc.

Horizon



Control Module & Fluid Names & Numbers

Control Module Location	CM #	CM Name in Software Map (10 Characters max)
	1	
	2	
	3	
	4	
	5	
	6	
	7	
	8	
	9	
	10	
	11	
	12	
	13	
	14	
	15	
	16	
	17	

Fluid Name	Units	Fluid #	Fluid Name in Software Map (10 Characters max)
		1	
		2	
		3	
		4	
		5	
		6	
		7	
		8	
		9	
		10	

Horizon Form #3



Graco, Inc.

Horizon





Dispense Area Names & Numbers

Dispense Area Location	DA #	Dispense Area Name in Software Map (10 Characters max)
	1	
	2	
	3	
	4	
	5	
	6	
	7	
	8	
	9	
	10	
	11	
	12	
	13	
	14	
	15	
	16	
	17	
	18	
	19	
	20	
	21	
	22	
	23	
	24	
	25	
	26	
	27	
	28	
	29	
	30	

Horizon Form #4

Graco, Inc.			FLUIDS										
Connection Assignments Record the Control Module # and port # for each solenoid (ports 1-6); number each meter consecutively (1,2,...) Example: CM1/3			Name	Name	Name	Name	Name	Name	Name	Name	Name		
			1	2	3	4	5	6	7	8	9	10	
D I S P E N S E A R E A S	1	Air Solenoid											
		Fluid Solenoid											
		Meter Number											
	2	Air Solenoid											
		Fluid Solenoid											
		Meter Number											
	3	Air Solenoid											
		Fluid Solenoid											
		Meter Number											
	4	Air Solenoid											
		Fluid Solenoid											
		Meter Number											
	5	Air Solenoid											
		Fluid Solenoid											
		Meter Number											
	6	Air Solenoid											
		Fluid Solenoid											
		Meter Number											
	7	Air Solenoid											
		Fluid Solenoid											
		Meter Number											
	8	Air Solenoid											
		Fluid Solenoid											
		Meter Number											
	9	Air Solenoid											
		Fluid Solenoid											
		Meter Number											
	10	Air Solenoid											
		Fluid Solenoid											
		Meter Number											
	11	Air Solenoid											
		Fluid Solenoid											
		Meter Number											
	12	Air Solenoid											
		Fluid Solenoid											
		Meter Number											
	13	Air Solenoid											
		Fluid Solenoid											
		Meter Number											

Horizon Form #5

		Graco, Inc. Horizon Meter Calibration Chart				
No.	Location	Fluid	CM #	Port #	Pulses Per	Unit
1						
2						
3						
4						
5						
6						
7						
8						
9						
10						
11						
12						
13						
14						
15						
16						
17						
18						
19						
20						
21						
22						
23						
24						
25						
26						
27						
28						
29						
30						
31						
32						
33						
34						
35						
36						
37						
38						
39						
40						

Horizon Form #6

Horizon Fluid Management Systems Warranty Registration and Checkout Form

1. Site Identification

Customer Name: _____
 Address: _____
 City/State/Zip: _____
 Phone Number: _____
 Key Contact Name: _____

2. Installer Identification

Company Name: _____
 Address: _____
 City/State/Zip: _____
 Phone Number: _____
 Key Contact Name: _____

3. System Hardware Identification and Checkout

	<u># in System</u>	<u>Operation Verified?</u>
Master Control Module	_____	_____
Slave Control Module(s)	_____	_____
Administrative Keypad	_____	_____
Enhanced Keypad/Barcode Reader	_____	_____
Basic Keypad	_____	_____
Air Solenoids	_____	_____
Fluid Solenoids	_____	_____
Oil Pulse Meters	_____	_____
AntiFreeze/WWF Pulse Meters	_____	_____

4. System Software Identification & Checkout

(check if/when completed)

Run Options Configured:	Passwords _____ Job # _____ Vehicle ID _____ Optional Field _____ Presets? _____	Output Options Configured:	Printer _____ Computer _____
-------------------------	--	----------------------------	---------------------------------

5. Attachments (MANDATORY!)

(check when attached)

_____ Copies of all System Design Forms
 _____ Copy of system map/floor plan
 _____ Printout of Software Setup

6. Installer Signoff

I certify that I have checked out all system components and functions, and that they operate according to system design specs and customer expectations.

Installer Name: _____
 Company: _____
 Date Completed: _____

7. Customer Signoff

I agree that the system has been installed to my expectations and that I have been informed as to proper system operation. I accept control of the system.

Customer Name: _____
 Company: _____
 Date Completed: _____

System Dynamics And Design Factors

There are some special factors that need to be considered when designing a fluid distribution system that will be controlled by a Horizon system.

Pressure Relief Kit

WARNING



A Pressure Relief Kit (A) is required in the Horizon system to reduce the risk of serious injury, caused by splashing fluid in the eyes or on the skin resulting from component rupture from over-pressurization. See Fig. 20. See page 80 to order the kit.

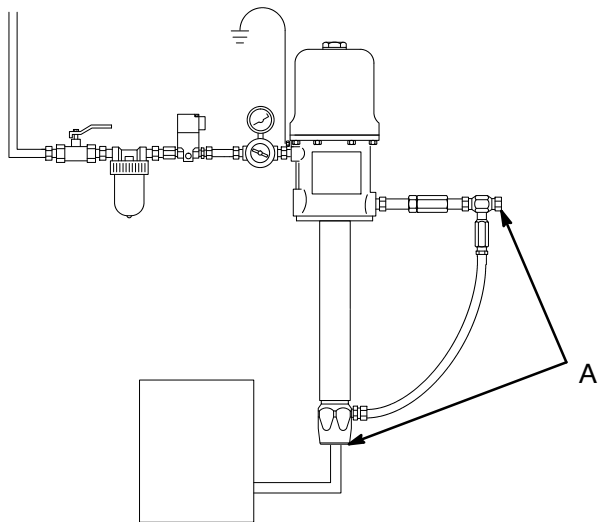

Fig. 20

06875

Ability to Dispense Fluid During System Failure

If this is a requirement, install a bypass near the fluid solenoid (B). If the control module that drives that fluid solenoid fails or the power fails in that area of the shop, the bypass can be used to keep fluid available. Fluid cannot be dispensed if the power to the entire shop goes down, as there will not be any power to the pumps air compressor. If a bypass is used, records of the jobs dispensed will not be available.

NOTE: Each control module has a DIP switch that can be used to turn on all the solenoids connected to it. See page 10 for more information.

Two Recommended Bypass Installations

1. See Fig. 21. This installation is a quick way of bypassing the fluid solenoid (B), but it can be costly if there are a number of reels to install the bypass valve (C) on.

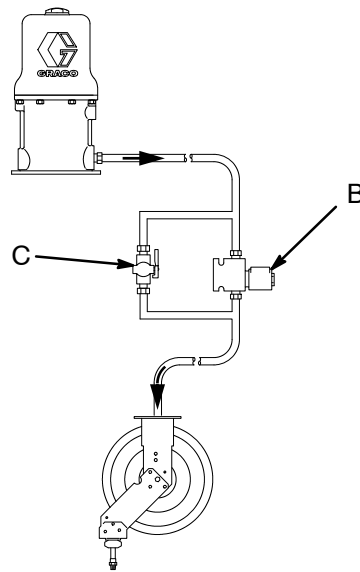

Fig. 21

06515

Continued on the next page.

System Dynamics And Design Factors

Ability to Dispense Fluid During System Failure (continued)

2. See Fig. 22. This installation is inexpensive, but it requires more effort to change the connections around the fluid solenoid (B), and the lines must be depressurized before making the change.

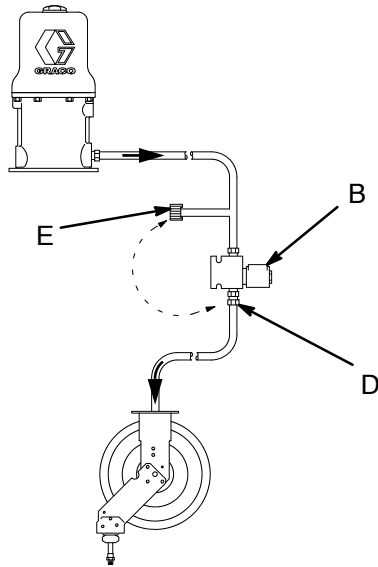

- 1 Change the hose reel connection from connector D to connector E to bypass Horizon system. Cap the connector that is not being used.

Fig. 22

In some cases, such as in mining applications, a design may be required that allows fluid to be dispensed regardless of the state of operation of the Horizon system. Fig. 23 represents the installation of a ball valve (F¹) that can be used to redirect the fluid around the Horizon pulse meter (G) and fluid solenoid (B). This is also useful when it is necessary to remove the solenoid, meter or filter (H) for cleaning or service. Ball valves F² and F³ can be used to isolate the meter and/or solenoid for service.

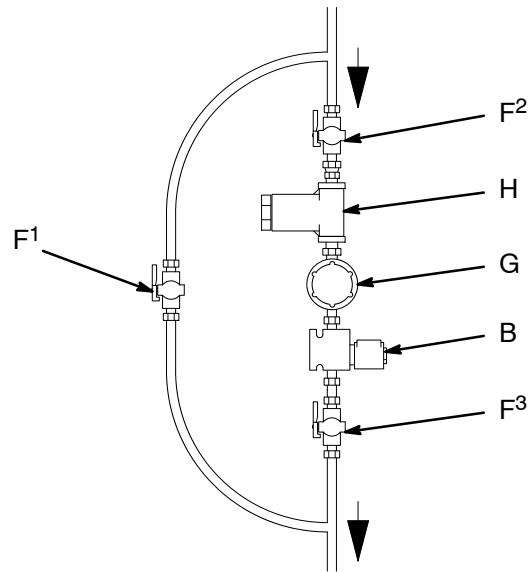

Fig. 23

06514

System Dynamics And Design Factors

Avoiding Pulsation When Simultaneous Dispensing Fluid

When simultaneously dispensing fluid, check valves (I) and pressure relief valves (J) need to be installed at each pulse meter (G) to prevent false readings on one meter while other meter, solenoid (B), and valve combinations are actively dispensing. See Fig. 24.

These false readings occur when one or more reels are actively dispensing and another reel is authorized to begin dispensing the same fluid. The fluid solenoid (B) to this newly activated reel is now open and waiting for the operator to open the valve. Its pulse meter (G) is also activated and ready to begin counting pulses.

Because the hose is expandable, fluid can flow in and out of it when the other operators open and close their valves and the pump operates. As this fluid moves back and forth through the pulse meter (G), the meter generates pulses which the system interprets as actual dispensing. Check valves (I) will prevent pulsations from reaching the pulse meters and creating false readings.

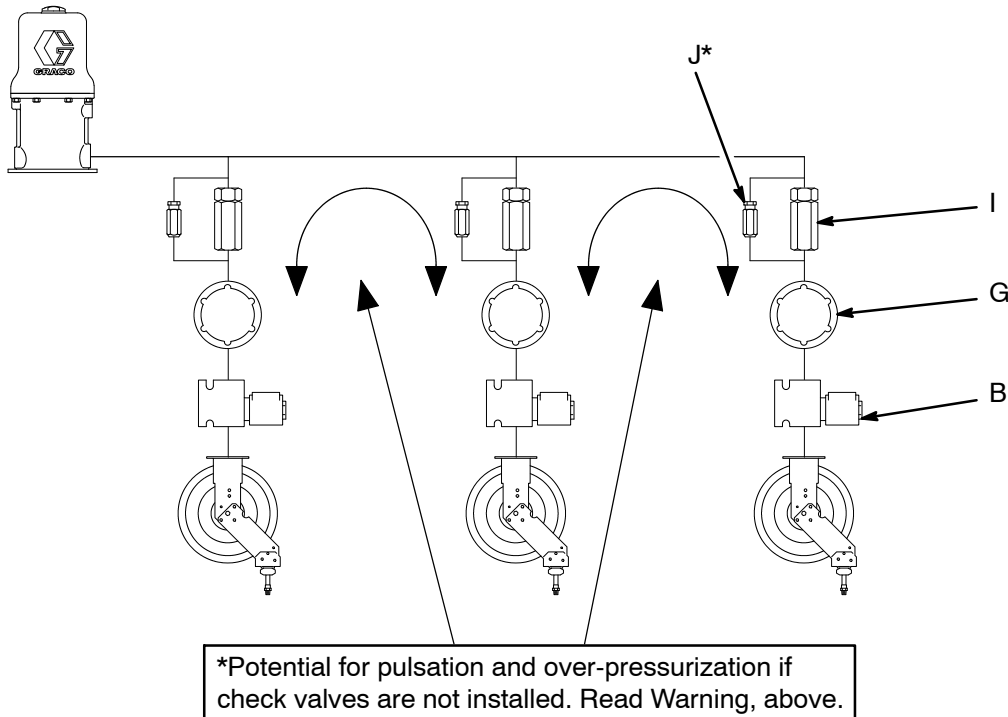

Fig. 24

⚠ WARNING

To reduce the risk of serious injury, the pressure relief valves (J) are required to prevent the system from over-pressurizing, which could be caused by thermal expansion of the fluids. See Fig. 20. See page 80 to order the valves.

Selecting a Supply Pump

If multiple reels will be dispensing fluid at the same time, a higher capacity pump is needed. The size of the pump (based on the volume of fluid delivered) can be computed by taking the expected flow rate from each valve, times the number of valves that could dispense simultaneously.

Technical Data

System Specifications

40 maximum	Control Modules in a system (1 Master only, plus 39 Slave)
40 maximum	Keypads in a system (1 keypad per Control Module; Administrators Keypad must be connected to the Master Control Module)
240 maximum	Solenoids in a system (40 Control Modules, 6 ports each)
240 maximum	Meters in a system (40 Control Modules, 6 ports each)
10 maximum	Fluids supported by a system
99 maximum	Dispense Areas (reel banks)
100 maximum	Operator Names/PIN numbers
668 maximum	Dispense Records stored
12 maximum	Simultaneous Dispenses (same and/or different fluids)
12 maximum	Jobs Waiting in Queue
1 maximum	Printer per system (must be connected to Master Control Module) OR Attached Computer per system (must be connected to Master Control Module)

Control Module Ports

6	Solenoid Ports per Control Module
6	Pulse Meter Ports per Control Module
1	Port for Keypad per Control Module
1	Port for printer or computer per Master Control Module
1	Bar code reader per control module

Voltage Input

110 Volts AC, 50/60 Hz, 2 amps maximum draw

220 Volts AC, 50/60 Hz, 1 amp maximum draw

Environment

Operating Temperature Range

40-140° F (4-60° C) ambient

Humidity Range

0-95% non-condensing

Preset or Free-flow Limits

999.9 Units Maximum Preset or free-flow dispense

0.5 Units Minimum Preset dispense

Dispense Units of Measure: liters, quarts, gallons or pints (configurable for each fluid)

Inventory Units of Measure: liters or gallons (dependent upon dispense units chosen)

Maximum Cable Lengths

50 ft. (15.3 m)	From Keypad to Control Module
50 ft. (15.3 m)	From Solenoid to Control Module
50 ft. (15.3 m)	From Pulse Meter to Control Module
50 ft. (15.3 m)	From Printer or Computer to Master Control Module
2000 ft. (610 m)	From one end of the Control Module Network to the other end (daisy-chained)

Graco Standard Warranty

Graco warrants all equipment manufactured by Graco and bearing its name to be free from defects in material and workmanship on the date of sale to the original purchaser for use. With the exception of any special, extended, or limited warranty published by Graco, Graco will, for a period of twelve months from the date of sale, repair or replace any part of the equipment determined by Graco to be defective. This warranty applies only when the equipment is installed, operated and maintained in accordance with Graco's written recommendations.

This warranty does not cover, and Graco shall not be liable for general wear and tear, or any malfunction, damage or wear caused by faulty installation, misapplication, abrasion, corrosion, inadequate or improper maintenance, negligence, accident, tampering, or substitution of non-Graco component parts. Nor shall Graco be liable for malfunction, damage or wear caused by the incompatibility of Graco equipment with structures, accessories, equipment or materials not supplied by Graco, or the improper design, manufacture, installation, operation or maintenance of structures, accessories, equipment or materials not supplied by Graco.

This warranty is conditioned upon the prepaid return of the equipment claimed to be defective to an authorized Graco distributor for verification of the claimed defect. If the claimed defect is verified, Graco will repair or replace free of charge any defective parts. The equipment will be returned to the original purchaser transportation prepaid. If inspection of the equipment does not disclose any defect in material or workmanship, repairs will be made at a reasonable charge, which charges may include the costs of parts, labor, and transportation.

THIS WARRANTY IS EXCLUSIVE, AND IS IN LIEU OF ANY OTHER WARRANTIES, EXPRESS OR IMPLIED, INCLUDING BUT NOT LIMITED TO WARRANTY OF MERCHANTABILITY OR WARRANTY OF FITNESS FOR A PARTICULAR PURPOSE.

Graco's sole obligation and buyer's sole remedy for any breach of warranty shall be as set forth above. The buyer agrees that no other remedy (including, but not limited to, incidental or consequential damages for lost profits, lost sales, injury to person or property, or any other incidental or consequential loss) shall be available. Any action for breach of warranty must be brought within two (2) years of the date of sale.

Graco makes no warranty, and disclaims all implied warranties of merchantability and fitness for a particular purpose in connection with accessories, equipment, materials or components sold but not manufactured by Graco. These items sold, but not manufactured by Graco (such as electric motors, switches, hose, etc.), are subject to the warranty, if any, of their manufacturer. Graco will provide purchaser with reasonable assistance in making any claim for breach of these warranties.

In no event will Graco be liable for indirect, incidental, special or consequential damages resulting from Graco supplying equipment hereunder, or the furnishing, performance, or use of any products or other goods sold hereto, whether due to a breach of contract, breach of warranty, the negligence of Graco, or otherwise.

FOR GRACO CANADA CUSTOMERS

The parties acknowledge that they have required that the present document, as well as all documents, notices and legal proceedings entered into, given or instituted pursuant hereto or relating directly or indirectly hereto, be drawn up in English. Les parties reconnaissent avoir convenu que la rédaction du présente document sera en Anglais, ainsi que tous documents, avis et procédures judiciaires exécutés, donnés ou intentés à la suite de ou en rapport, directement ou indirectement, avec les procédures concernées.

Graco Information

TO PLACE AN ORDER, contact your Graco distributor, or call one of the following numbers to identify the distributor closest to you:

1-800-533-9655 Toll Free; 612-623-6928; 612-378-3590 Fax

Patent Information: www.graco.com/patents

*All written and visual data contained in this document reflect the latest product information available at the time of publication.
Graco reserves the right to make changes at any time without notice.*

This manual contains English. MM 308607

Graco Headquarters: Minneapolis

International Offices: Belgium, Korea, China, Japan

GRACO INC. P.O. BOX 1441 MINNEAPOLIS, MN 55440-1441

Copyright 1997, Graco Inc. is registered to I.S. EN ISO 9001

www.graco.com

Revised December 2014