

GH™ Series Big Rig Sprayers

332156B

EN

- Use with Architectural Coatings, Paints, Roof Coatings and Below Grade Coatings -

Model	Description	Maximum Working Pressure
16U277	GH1017es Bare	1000 psi (6.9 MPa, 69 bar)
16U278	GH2570es Bare	2500 psi (17.2 MPa, 172 bar)
16U279	GH733es Bare	4000 psi (27.6 MPa, 276 bar)
16U280	GH5040es Bare	5000 psi (34.5 MPa, 345 bar)
16U285	GH933es Bare	7250 psi (50.0 MPa, 500 bar)
16U281	GH933 Bare	7250 psi (50.0 MPa, 500 bar)



Important Safety Instructions

Read all warnings and instructions in this manual. Save these instructions.

Related Manuals:



311254
312145



332157



332158



308043
311825
311762

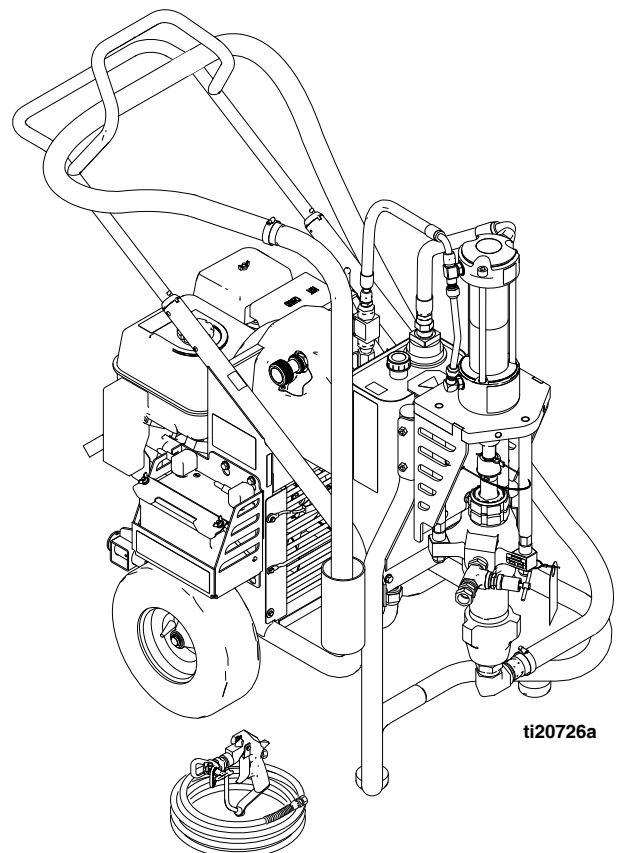

ti20726a















Contents

- Warnings3**
- Component Identification5**
- Lift Instructions6**
- Pressure Relief Procedure7**
- Setup8**
- Startup9**
- Spraying12**
- Cleanup13**
- Troubleshooting15**
- Notes17**
- Graco Standard Warranty18**

Warnings

The following warnings are for the setup, use, grounding, maintenance, and repair of this equipment. The exclamation point symbol alerts you to a general warning and the hazard symbols refer to procedure-specific risks. When these symbols appear in the body of this manual or on warning labels, refer back to these Warnings. Product-specific hazard symbols and warnings not covered in this section may appear throughout the body of this manual where applicable.

 WARNING	
	<p>FIRE AND EXPLOSION HAZARD</p> <p>Flammable fumes, such as solvent and paint fumes, in work area can ignite or explode. To help prevent fire and explosion:</p> <ul style="list-style-type: none"> • Use equipment only in well ventilated area. • Eliminate all ignition sources; such as pilot lights, cigarettes, portable electric lamps, and plastic drop cloths (potential static arc). • Keep work area free of debris, including solvent, rags and gasoline. • Do not plug or unplug power cords, or turn power or light switches on or off when flammable fumes are present. • Ground all equipment in the work area. See Grounding instructions. • Use only grounded hoses. • Hold gun firmly to side of grounded pail when triggering into pail. Do not use pail liners unless they are antistatic or conductive. • Stop operation immediately if static sparking occurs or you feel a shock. Do not use equipment until you identify and correct the problem. • Keep a working fire extinguisher in the work area.
	<p>SKIN INJECTION HAZARD</p> <p>High-pressure spray is able to inject toxins into the body and cause serious bodily injury. In the event that injection occurs, get immediate surgical treatment.</p> <ul style="list-style-type: none"> • Do not aim the gun at, or spray any person or animal. • Keep hands and other body parts away from the discharge. For example, do not try to stop leaks with any part of the body. • Always use the nozzle tip guard. Do not spray without nozzle tip guard in place. • Use Graco nozzle tips. • Use caution when cleaning and changing nozzle tips. In the case where the nozzle tip clogs while spraying, follow the Pressure Relief Procedure for turning off the unit and relieving the pressure before removing the nozzle tip to clean. • Do not leave the unit energized or under pressure while unattended. When the unit is not in use, turn off the unit and follow the Pressure Relief Procedure for turning off the unit. • Check hoses and parts for signs of damage. Replace any damaged hoses or parts. • This system is capable of producing 7250 psi (50.0 MPa, 500 bar). Use Graco replacement parts or accessories that are rated a minimum of 7250 psi (50.0 MPa, 500 bar). • Always engage the trigger lock when not spraying. Verify the trigger lock is functioning properly. • Verify that all connections are secure before operating the unit. • Know how to stop the unit and bleed pressure quickly. Be thoroughly familiar with the controls.

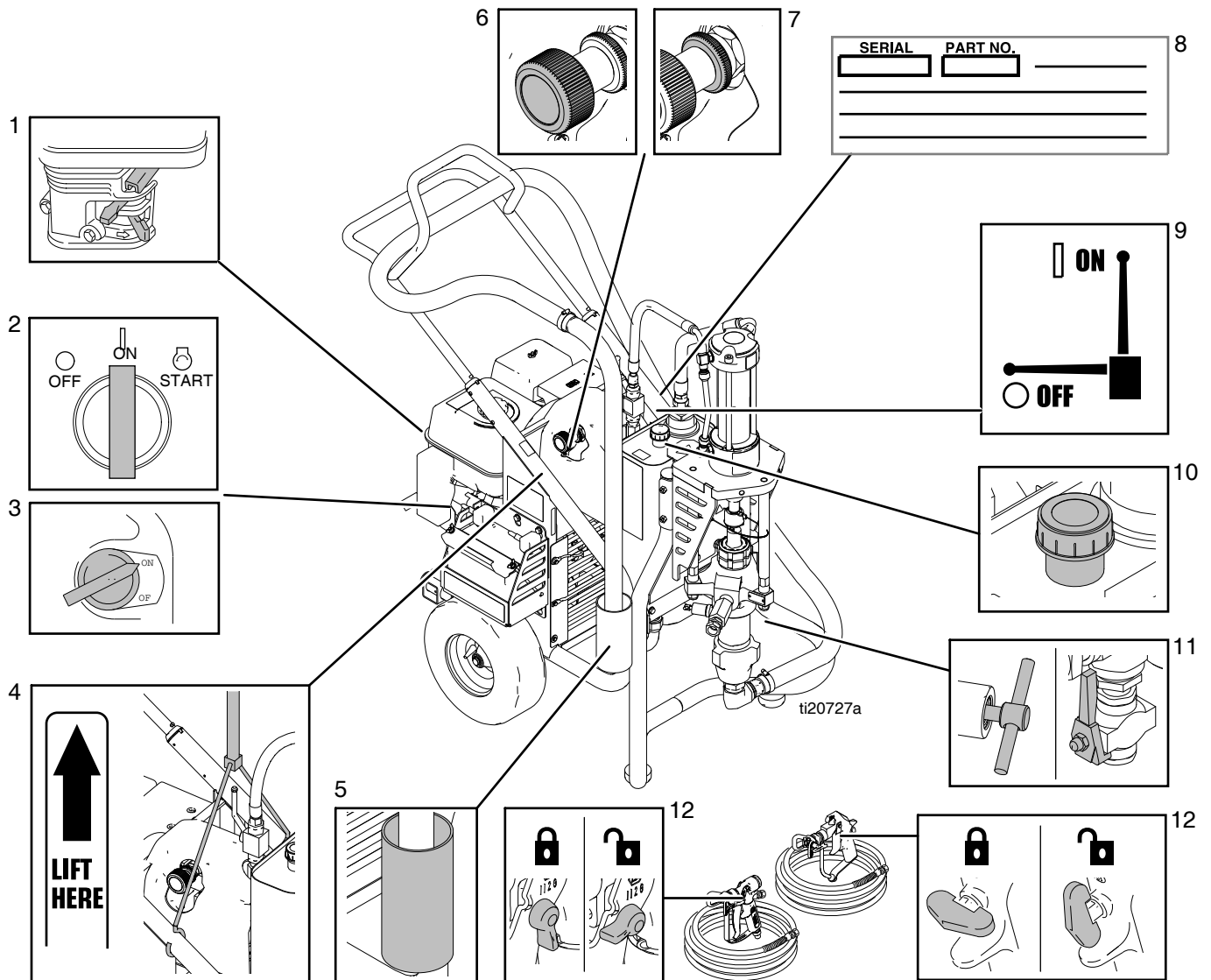

 WARNING	
 	<p>MOVING PARTS HAZARD</p> <p>Moving parts can pinch, cut or amputate fingers and other body parts.</p> <ul style="list-style-type: none"> • Keep clear of moving parts. • Do not operate equipment with protective guards or covers removed. • Pressurized equipment can start without warning. Before checking, moving, or servicing equipment, follow the Pressure Relief Procedure and disconnect all power sources.
	<p>SUCTION HAZARD</p> <p>Powerful suction could cause serious injury.</p> <ul style="list-style-type: none"> • Never place hands near the pump fluid inlet when pump is operating or pressurized.
	<p>CARBON MONOXIDE HAZARD</p> <p>Exhaust contains poisonous carbon monoxide, which is colorless and odorless. Breathing carbon monoxide can cause death.</p> <ul style="list-style-type: none"> • Do not operate in an enclosed area.
	<p>TOXIC FLUID OR FUMES HAZARD</p> <p>Toxic fluids or fumes can cause serious injury or death if splashed in the eyes or on skin, inhaled, or swallowed.</p> <ul style="list-style-type: none"> • Read MSDSs to know the specific hazards of the fluids you are using. • Store hazardous fluid in approved containers, and dispose of it according to applicable guidelines.
	<p>BATTERY SAFETY</p> <p>The battery may leak, explode, cause burns, or cause an explosion if mishandled.</p> <ul style="list-style-type: none"> • Only use the battery type specified for use with the equipment. See Technical Data. • Battery maintenance must only be performed or supervised by personnel knowledgeable of batteries and the required precautions. Keep unauthorized personnel away from battery. • Do not dispose of battery in fire. The battery is capable of exploding. • Follow local ordinances and/or regulations for disposal. • Do not open or mutilate the battery. Released electrolyte has been known to be harmful to the skin and eyes and to be toxic. • Remove watches, rings, or other metal objects. • Only use tools with insulated handles. Do not lay tools or metal parts on top of battery.
	<p>BURN HAZARD</p> <p>Equipment surfaces and fluids that are heated can become very hot during operation. To avoid severe burns:</p> <ul style="list-style-type: none"> • Do not touch hot fluid or equipment.
	<p>PERSONAL PROTECTIVE EQUIPMENT</p> <p>Wear appropriate protective equipment when in the work area to help prevent serious injury, including eye injury, hearing loss, inhalation of toxic fumes, and burns. This protective equipment includes but is not limited to:</p> <ul style="list-style-type: none"> • Protective eyewear, and hearing protection. • Respirators, protective clothing, and gloves as recommended by the fluid and solvent manufacturer.
	<p>CALIFORNIA PROPOSITION 65</p> <p>The engine exhaust from this product contains a chemical known to the State of California to cause cancer, birth defects or other reproductive harm.</p> <p>This product contains a chemical known to the State of California to cause cancer, birth defects or other reproductive harm. Wash hands after handling.</p>

Component Identification



1	Engine Controls
2	Engine ON/OFF Switch (Electric-Start Units)
3	Engine ON/OFF Switch (Pull-Start Units)
4	Lift Location
5	Suction Tube Holder
6	Pressure Control
7	Lock Ring
8	Serial Number ID Label
9	Hydraulic Pump Valve
10	Hydraulic Oil Fill
11	Pressure Bleed Valve, T handle
12	Trigger Lock

Lift Instructions

						
---	---	--	--	--	--	--

To avoid injury, always use designated Lift Locations when lifting the unit. When lifting the unit, only use ANSI approved slings and equipment rated for a minimum of 500 lb (227 kg). Always use ANSI approved equipment for securing the unit to transporting equipment.

1. When lifting sprayer, balance weight evenly across two straps/chains as shown.

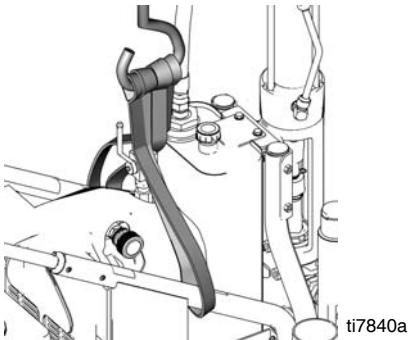

2. Wrap each strap/chain securely around frame where indicated on frame label as shown.

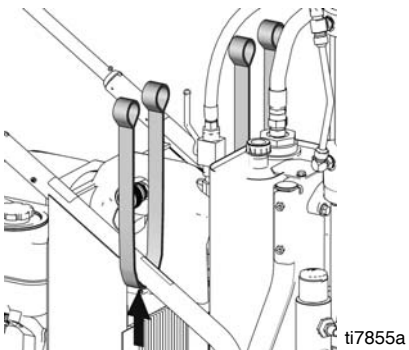

3. Be sure straps/chains used for lifting are rated to support weight of sprayer: 500 lbs (227 kg).
4. Do not lift unit with only one strap secured across pump. This could put stress on frame and damage pump.

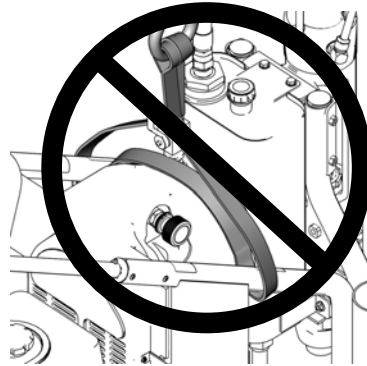

ti7838a

Pressure Relief Procedure



Follow the Pressure Relief Procedure whenever you see this symbol.



This equipment stays pressurized until pressure is manually relieved. To help prevent serious injury from pressurized fluid, such as skin injection, splashing fluid and moving parts, follow the Pressure Relief Procedure when you stop spraying and before cleaning, checking, or servicing the equipment.

1. Set pump valve OFF.

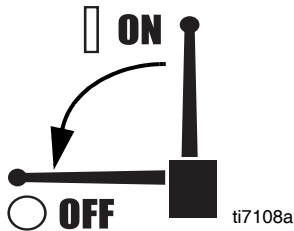

2. Turn engine OFF.

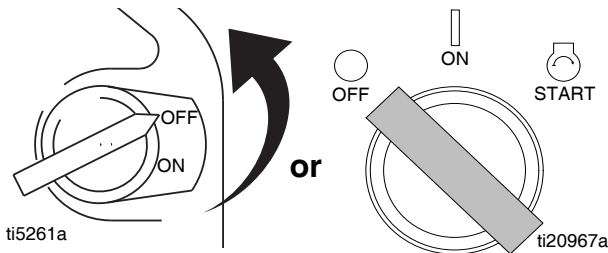

3. Loosen Lock Ring. Turn pressure control to lowest setting. Trigger gun into pail to relieve pressure.

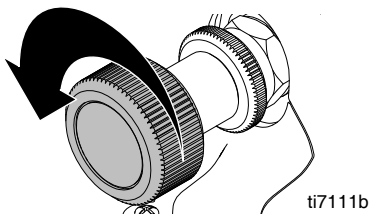

4. Rotate handle counter-clockwise to open prime valve.

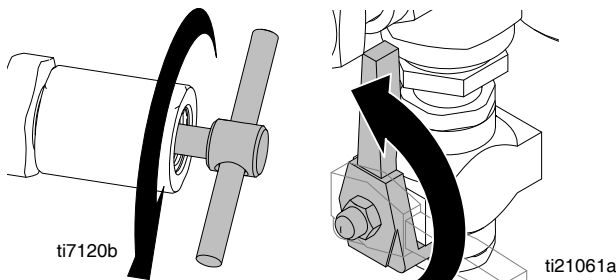

Grounding

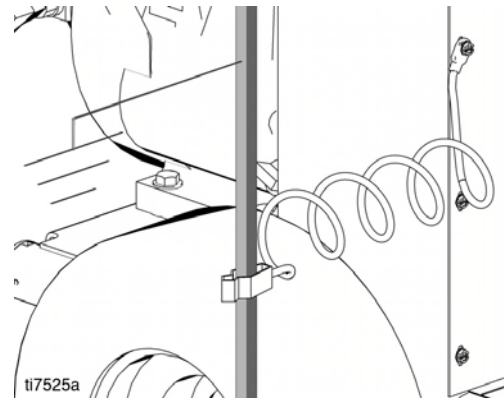
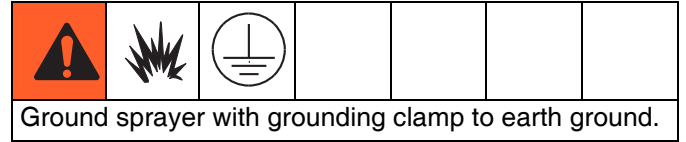

Setup



1. Connect appropriate Graco high-pressure hose to sprayer. Tighten securely.

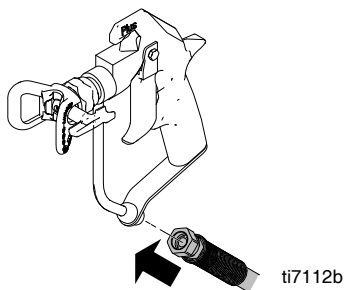

NOTE: Remove second gun port plug for multiple guns and repeat steps 1 - 4.

2. Connect other end of hose to gun and tighten fittings securely.

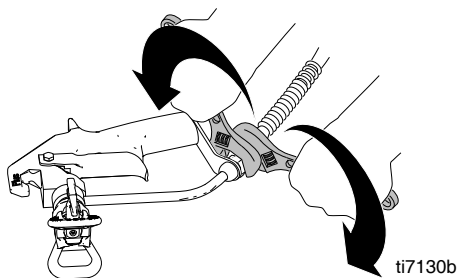

3. Remove tip guard.

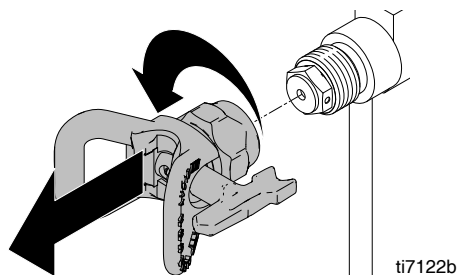

4. Install clean inlet strainer.

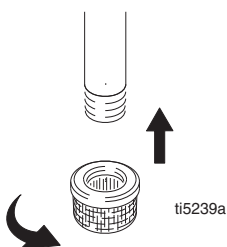

5. Fill throat packing nut with TSL to prevent premature packing wear. Do this each time you spray and store.

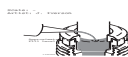

6. Check engine oil level. Add SAE 10W-30 (summer) or 5W-20 (winter), if necessary.

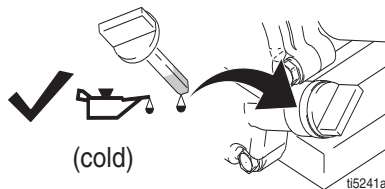

7. Fill fuel tank.

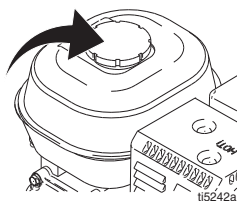

8. Check hydraulic oil level, Component ID, page ##. Add only Graco Hydraulic Oil, ISO 46 169236 (5 gallon/18.9 liter) or 207428 (1 gallon/3.8 liter). Hydraulic tank capacity is approximately 4.0 gallons (15.14 liters).



9. Verify all hose/fitting connections are tight.

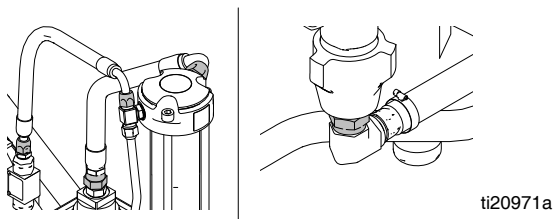

10. Attach sprayer grounding clamp to earth ground to prevent static charge build-up that may result in fire.

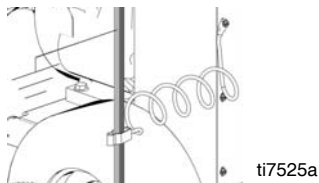

Startup



Hydraulic system and engine may become very hot during operation and could burn skin if touched. Flammable materials spilled on hot, bare motor could cause fire or explosion. Have belt guard in place during operation to reduce risk of pinching or loss of fingers.

1. Place suction tube and drain tube in grounded metal pail partially filled with flushing fluid. Attach ground wire to pail and to ground wire to earth ground.

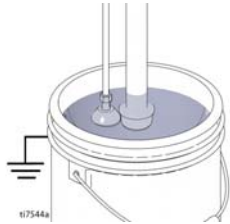

2. Rotate handle counter-clockwise to open prime valve.

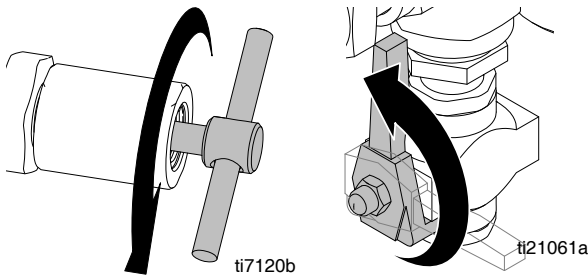

3. Loosen lock nut and turn pressure control counter-clockwise to lowest pressure.

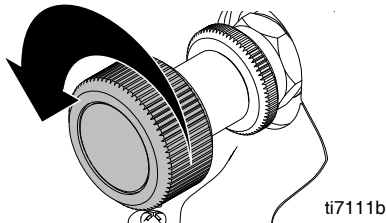

4. Set pump valve OFF.

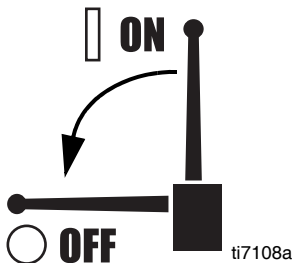

5. Start engine.

- a. Move fuel valve to open.

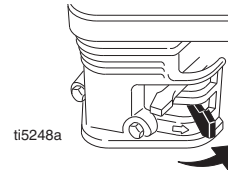

- b. Move choke to closed.

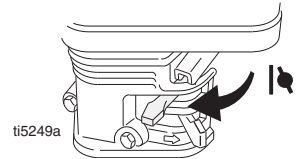

- c. Set throttle to fast.

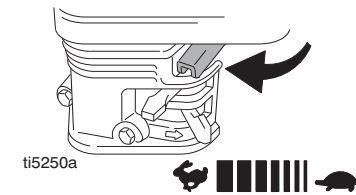

- d. **For electric start models:** Rotate key to start.

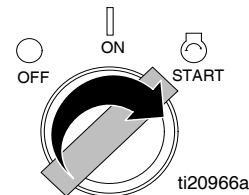

For pull-start models: Set engine switch to ON. Pull starter rope or turn ignition key.

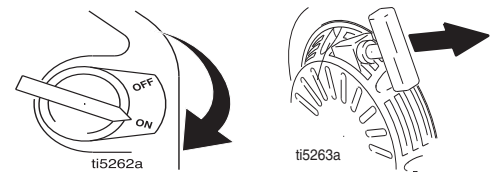

- e. After engine starts, move choke to open.



- f. Set throttle to desired setting.



6. Set pump valve ON (hydraulic motor is now active).

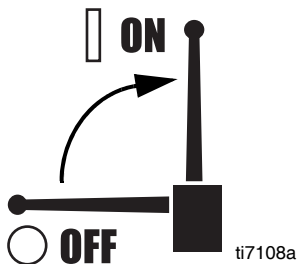

7. Increase pressure enough to start hydraulic motor stroking and allow fluid to circulate for 15 seconds; turn pressure down.

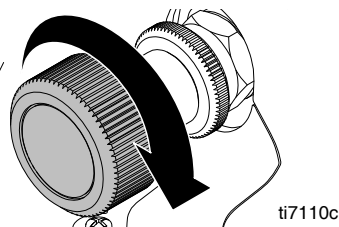

8. Close prime valve by rotating handle clockwise.

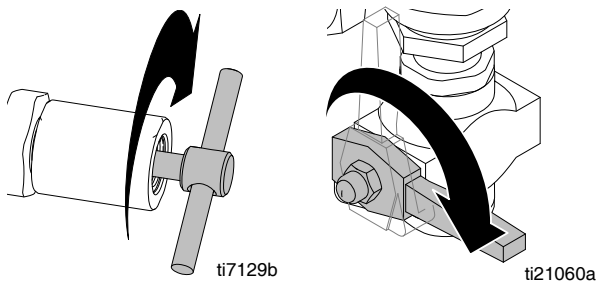

9. Take spray gun trigger safety OFF.

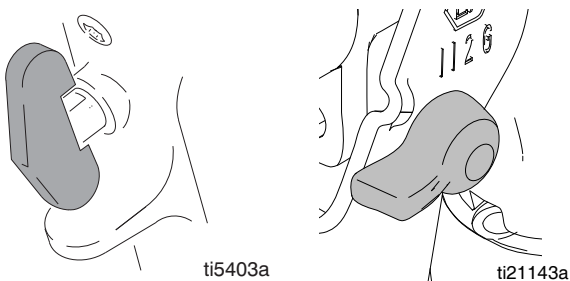

10. Hold gun against grounded metal flushing pail. Trigger gun and increase fluid pressure slowly until pump runs smoothly.

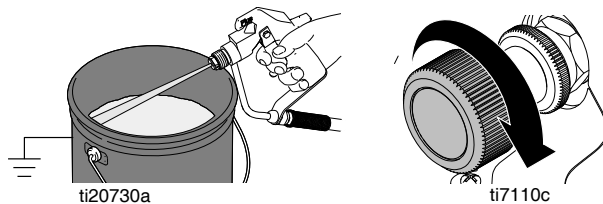

11. Inspect fittings for leaks. Do not stop leaks with your hand or a rag! If leaks occur, turn sprayer OFF immediately. **Relieve pressure**, page 7. Tighten leaky fittings. Repeat Startup, steps 1 - 5. If no leaks, continue to trigger gun until system is thoroughly flushed. Proceed to step 6.

12. Place siphon tube in paint pail.

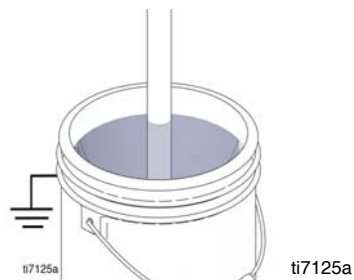

13. Trigger gun again into flushing fluid pail until paint appears. Assemble tip and guard, page 11.

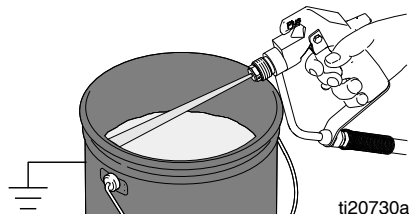

SwitchTip and Guard Assembly

1. Insert SwitchTip. Insert seat and OneSeal.

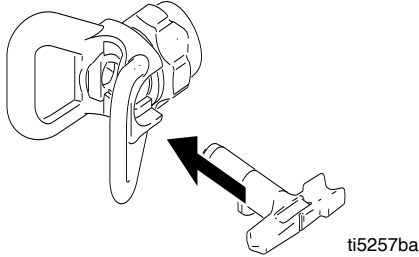

NOTE: Before screwing tip and guard assembly on gun, perform **Pressure Relief Procedure**, page 7, and be sure gun trigger safety is ON.

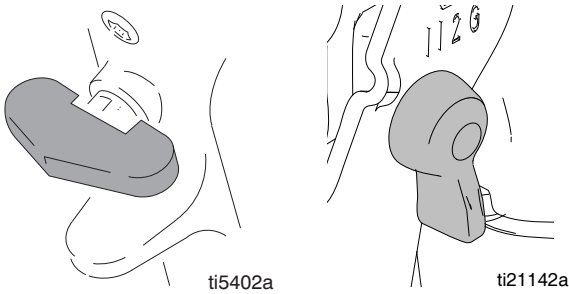

2. Screw assembly onto gun. Hand tighten.

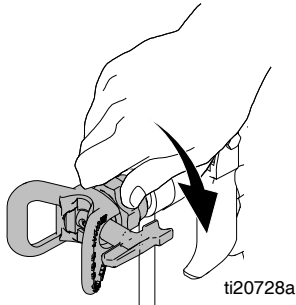

Clearing Tip Clogs

1. Release trigger, put trigger safety ON. Rotate SwitchTip. Take trigger safety OFF and trigger gun to clear the clog.

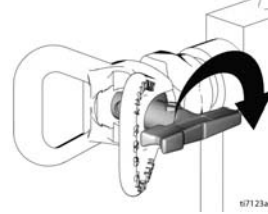

2. Put trigger safety ON, return SwitchTip to original position, take trigger safety OFF and continue spraying.

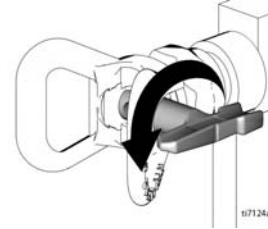

3. If you suspect the spray tip or hose is clogged or that pressure has not been fully relieved after following the steps above, **VERY SLOWLY** loosen tip guard retaining nut or hose end coupling to relieve pressure gradually, then loosen completely. Clear hose or tip obstruction.

Spraying

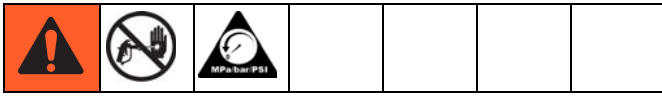

1. Set pump valve ON.

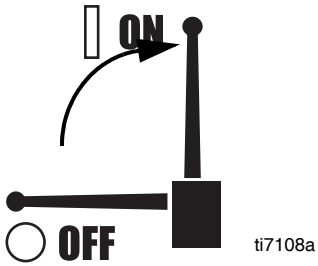

2. Increase pressure enough to start hydraulic motor stroking and allow fluid to circulate for 15 seconds; turn pressure down.

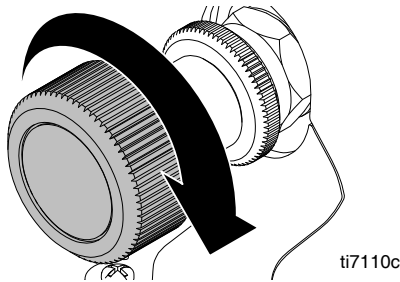

3. Turn spray gun trigger safety OFF.

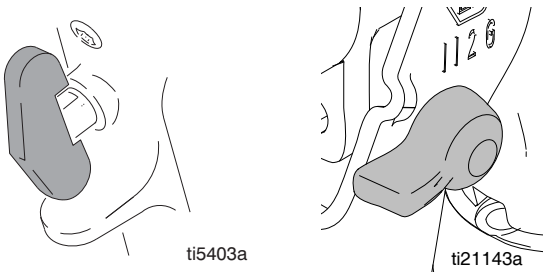

4. Adjust pressure to desired setting. Begin spraying.

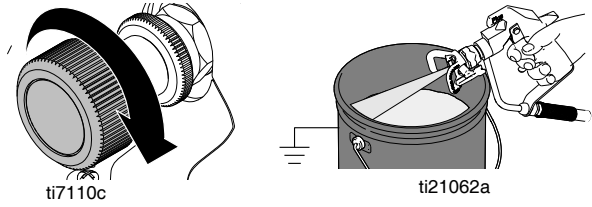

5. Rotate Lock Ring clockwise to set pressure.

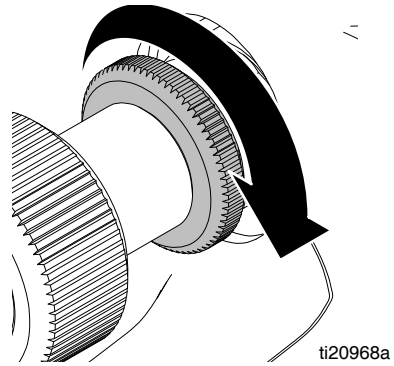

Cleanup



1. Perform **Pressure Relief Procedure**, page 7.

2. Remove guard and SwitchTip.

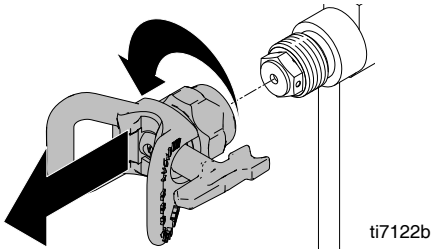

3. **GH933 units only:** Unscrew bowl, remove filter. Assemble without filter.

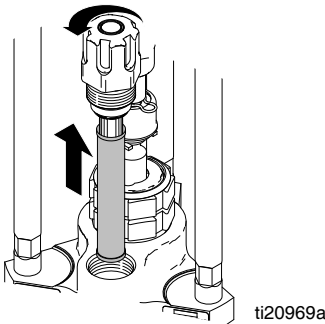

4. Clean filter, guard and SwitchTip in flushing fluid.



5. Remove siphon tube set from paint and place in flushing fluid. Use water for water base paint and mineral spirits for oil base paint.

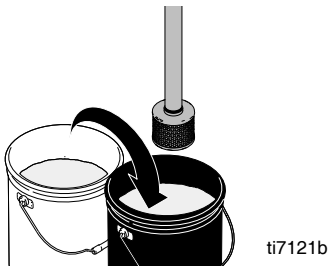

6. Turn engine ON and start engine.

7. Set pump valve ON. Rotate handle clockwise to close prime valve.

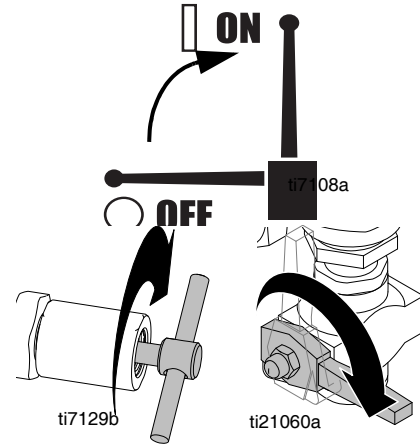

8. Hold gun against paint pail. Take trigger safety OFF. Turn pressure control up until motor begins to drive pump.

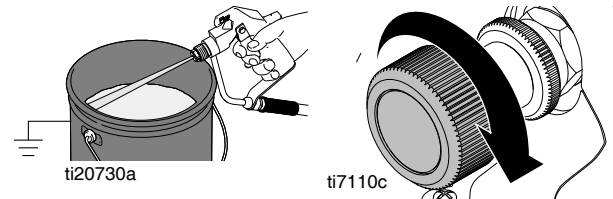

9. Trigger gun until flushing fluid appears.

10. Move gun to flushing pail, hold gun against pail, trigger gun to thoroughly flush system. Release trigger and put trigger safety ON.

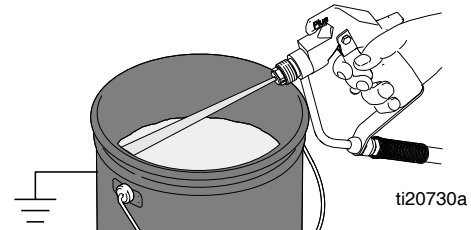

11. Rotate handle counter-clockwise to open prime valve and allow flushing fluid to circulate for approximately 20 seconds to clean drain tube.

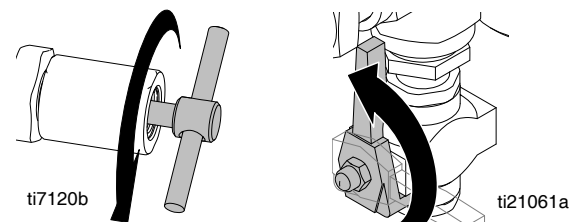

Cleanup

12. Raise siphon tube above flushing fluid and run sprayer for 15 to 30 seconds to drain fluid.

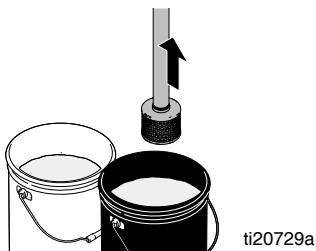

13. Turn pump valve OFF. Turn engine OFF.

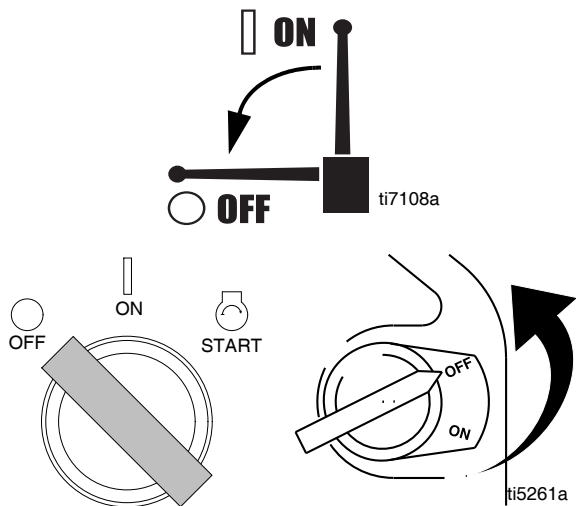

Caution: If flushing with water, do not leave water in sprayer. Flush again with mineral spirits, oil or Pump Armor and leave this protective coating in the sprayer to help prevent freezing or corrosion and increase sprayer life.

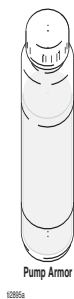

14. Rotate handle clockwise to close prime valve. Trigger gun into flushing pail to purge fluid from hose.

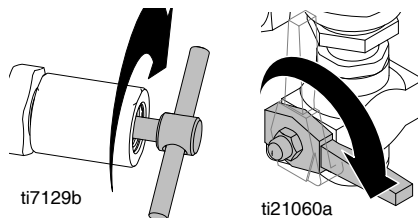

15. Rotate handle counter-clockwise to open prime valve.

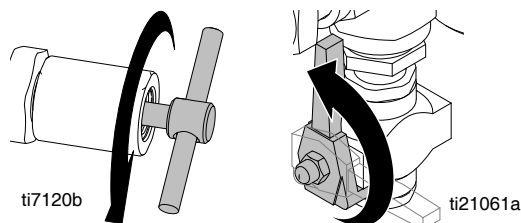

16. If pump includes filter, install filter into filter bowl. Make sure plastic center tube is tightened securely. Hand tighten filter bowl. Hand tighten gun handle.

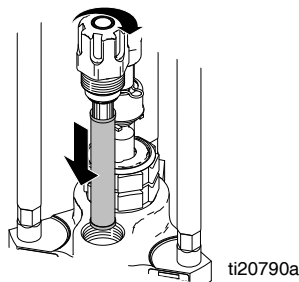

17. Clean tip, guard and gasket with a soft bristle brush to prevent part failure due to dried materials. Assemble parts and attach loosely onto gun. Wipe sprayer, hose and gun with a rag soaked in water or mineral spirits.

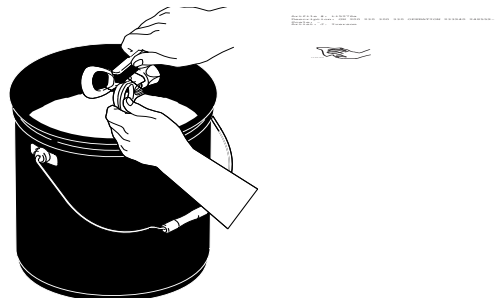

Troubleshooting

PROBLEM	CAUSE	SOLUTION
Gas engine pulls hard (will not start).	Hydraulic pressure is too high.	Turn hydraulic pressure knob counterclockwise to lowest setting.
Gas engine does not start.	Switch OFF, low oil, no gasoline, or dead battery.	Consult engine manual, supplied. Replace battery if necessary.
Gas engine doesn't work properly.	Faulty engine.	Consult engine manual, supplied.
Gas engine operates, but displacement pump doesn't operate.	Pump valve is OFF.	Set pump valve ON.
	Pressure setting too low.	Increase pressure.
	Displacement pump outlet filter (if used) is dirty or clogged.	Clean the filter.
	Tip or tip filter (if used) is clogged.	Remove tip and/or filter and clean.
	Hydraulic fluid too low.	Shut off sprayer. Add fluid*
	Belt worn, broken or off.	Replace. See manual 332157.
	Hydraulic pump worn or damaged.	Bring sprayer to Graco distributor for repair.
	Dried paint seized paint pump rod.	Service pump. See manuals 308043, 311825, 311762.
Displacement pump operates, but output is low on upstroke.	Hydraulic motor not shifting.	Set pump valve OFF. Turn pressure down. Turn engine OFF. Pry rod up or down until hydraulic motor shifts. See manual 332157.
	Piston ball check not seating properly.	Service piston ball check. See manual 308043, 311825, 311762.
Displacement pump operates but output is low on downstroke and/or on both strokes.	Piston packings worn or damaged.	Replace packings. See manuals 308043, 311825, 311762.
	Intake valve ball check not seating properly.	Service intake valve ball check. See manuals 308043, 311825, 311762.
	Suction tube air leak.	Repair or replace suction tube.
Paint leaks and runs over side of wetcup.	Loose wet-cup.	Tighten wet-cup enough to stop leakage.
	Throat packings worn or damaged.	Replace packings. See manuals 308043, 311825, 311762.
Excessive leakage around hydraulic motor piston rod wiper.	Piston rod seal worn or damaged.	Replace these parts. See manuals 308043, 311825, 311762.

PROBLEM	CAUSE	SOLUTION
Fluid delivery is low.	Pressure setting too low	Increase pressure, page 4
	Displacement pump outlet filter (if used) is dirty or clogged	Clean filter
	Intake line to pump inlet is not tight	Tighten intake line
	Hydraulic motor is worn or damaged	Bring sprayer to Graco distributor for repair
	Large pressure drop in fluid hose.	Use larger diameter or shorter hose.
The sprayer overheats	Paint buildup on hydraulic components	Clean
	Oil level is low	Fill with oil.
Spitting from gun	Air in fluid pump or hose	Check for loose connections on siphon assembly, tighten, then reprime pump
	Loose intake suction	Tighten
	Fluid supply is low or empty	Refill supply container
Excessive hydraulic pump noise	Low hydraulic fluid level	Turn sprayer OFF. Add fluid*
*Check hydraulic fluid level often. Do not allow it to become too low. Use only Graco approved hydraulic fluid, page 7.		

Technical Data

GH733ES		
	US	Metric
Sprayer		
Hydraulic Pressure	2750 psi	190 bar
Hydraulic Reservoir Capacity	4.0 gallons	15.1 liters
Honda Motor	13 HP	9.7 KW
Maximum Delivery	4.0 gpm	15.1 lpm
Maximum Pressure	4000 psi	276 bar
Maximum Tip Size		
• 1 gun	.065 in.	1.65 mm
• 2 guns	.046 in.	1.16 mm
• 3 guns	.037 in.	0.93 mm
• 4 guns	.032 in.	0.81 mm
• 5 guns	.029 in.	0.71 mm
• 6 guns	.026 in.	0.66 mm
Fluid Inlet	1.25 in. npt(m)	3.2 cm npt(f)
Fluid Outlet (with fitting as shipped)	0.75 in. nps(f) swivel	1.9 cm npsm
Fluid Outlet Pump	1.0 in. npt(f)	2.5 cm npt(f)
Dimensions		
Weight	434 lb	197 kg
Height	49 in.	124 cm
Width	28 in.	71 cm
Length	43 in.	109 cm
Sounds Levels*		
Sound Pressure	91 dB(A)	
Sound Power	106 dB(A)	
*measured at maximum normal load conditions		
Wetted Parts		
Displacement Pump	steel, nitralloy, tungsten, carbide, PTFE, leather, polyethylene	
Miscellaneous		
Graco-Approved Hydraulic Oil		
169236	5 gallons	19 liters
207428	1 gallon	3.8 liters

GH5040ES		
	US	Metric
Sprayer		
Hydraulic Pressure	2750 psi	190 bar
Hydraulic Reservoir Capacity	4.0 gallons	15.1 liters
Honda Motor	13 HP	9.7 KW
Maximum Delivery	3.5 gpm	13.2 lpm
Maximum Pressure	5000 psi	344.7 bar
Maximum Tip Size		
• 1 gun	.067 in.	1.70 mm
• 2 guns	.048 in.	1.22 mm
• 3 guns	.039 in.	0.99 mm
• 4 guns	.035 in.	0.89 mm
• 5 guns	.031 in.	0.79 mm
• 6 guns	.028 in.	0.71 mm
Fluid Inlet	1.25 in. npt(m)	3.2 cm npt(f)
Fluid Outlet (with fitting as shipped)	0.75 in. nps(f) swivel	1.9 cm npsm
Fluid Outlet Pump	1.0 in. npt(f)	2.5 cm npt(f)
Dimensions		
Weight	438 lb	199 kg
Height	49 in.	124 cm
Width	28 in.	71 cm
Length	43 in.	109 cm
Sounds Levels*		
Sound Pressure	91 dB(A)	
Sound Power	106 dB(A)	
*measured at maximum normal load conditions		
Wetted Parts		
Displacement Pump	steel, nitralloy, tungsten, carbide, PTFE, leather, polyethylene	
Miscellaneous		
Graco-Approved Hydraulic Oil		
169236	5 gallons	19 liters
207428	1 gallon	3.8 liters

GH1017ES		
	US	Metric
Sprayer		
Hydraulic Pressure	2750 psi	190 bar
Hydraulic Reservoir Capacity	4.0 gallons	15.1 liters
Honda Motor	13 HP	9.7 KW
Maximum Delivery	16.5 gpm	62.5 lpm
Maximum Pressure	1000 psi	69 bar
Maximum Tip Size		
• 1 gun	n/a	n/a
• 2 guns	n/a	n/a
• 3 guns	n/a	n/a
• 4 guns	n/a	n/a
• 5 guns	n/a	n/a
• 6 guns	n/a	n/a
Fluid Inlet	2 in. npt(f)	5 cm npt(f)
Fluid Outlet (with fitting as shipped)	0.75 in. nps(f) swivel	1.9 cm npsm
Fluid Outlet Pump	1.5 in. npt(f)	3.8 cm npt(f)
Dimensions		
Weight	473 lb	215 kg
Height	49 in.	124 cm
Width	28 in.	71 cm
Length	43 in.	109 cm
Sounds Levels*		
Sound Pressure	91 dB(A)	
Sound Power	106 dB(A)	
*measured at maximum normal load conditions		
Wetted Parts		
Displacement Pump	steel, nitralloy, tungsten, carbide, PTFE, leather	
Miscellaneous		
Graco-Approved Hydraulic Oil		
169236	5 gallons	19 liters
207428	1 gallon	3.8 liters

GH2570ES		
	US	Metric
Sprayer		
Hydraulic Pressure	2750 psi	190 bar
Hydraulic Reservoir Capacity	4.0 gallons	15.1 liters
Honda Motor	13 HP	9.7 KW
Maximum Delivery	7.0 gpm	26.5 lpm
Maximum Pressure	2500 psi	172.3 bar
Fluid Inlet	2 in. npt(f)	5 cm npt(f)
Fluid Outlet (with fitting as shipped)	0.75 in. nps(f) swivel	1.9 cm npsm
Fluid Outlet Pump	1.5 in. npt(m)	3.8 cm npt(m)
Dimensions		
Weight	471 lb	214 kg
Height	49 in.	124 cm
Width	28 in.	71 cm
Length	43 in.	109 cm
Sounds Levels*		
Sound Pressure	91 dB(A)	
Sound Power	106 dB(A)	
*measured at maximum normal load conditions		
Wetted Parts		
Displacement Pump	steel, nitralloy, tungsten, carbide, PTFE, leather	
Miscellaneous		
Graco-Approved Hydraulic Oil		
169236	5 gallons	19 liters
207428	1 gallon	3.8 liters

GH933ES, GH933		
	US	Metric
Sprayer		
Hydraulic Pressure	2750 psi	190 bar
Hydraulic Reservoir Capacity	4.0 gallons	15.1 liters
Honda Motor	13 HP	9.7 KW
Maximum Delivery	2.5 gpm	9.5 lpm
Maximum Pressure	7250 psi	500 bar
Maximum Tip Size		
• 1 gun	.065 in.	1.65 mm
Fluid Inlet	1.25 in. npt(m)	3.2 cm npt(f)
Fluid Outlet Pump	0.5 in. npt(f)	1.8 cm npt(f)
Fluid Outlet (with fitting as shipped)	0.5 in. npt(m)	1.8 cm npt(m)
Dimensions		
Weight	438 lb	199 kg
Height	49 in.	124 cm
Width	28 in.	71 cm
Length	43 in.	109 cm
Sounds Levels*		
Sound Pressure	91 dB(A)	
Sound Power	106 dB(A)	
*measured at maximum normal load conditions		
Wetted Parts		
Displacement Pump	steel, nitralloy, tungsten, carbide, PTFE, leather, polyethylene	
Filter	polyethylene, stainless steel	
Miscellaneous		
Graco-Approved Hydraulic Oil		
169236	5 gallons	19 liters
207428	1 gallon	3.8 liters

Graco Standard Warranty

Graco warrants all equipment referenced in this document which is manufactured by Graco and bearing its name to be free from defects in material and workmanship on the date of sale to the original purchaser for use. With the exception of any special, extended, or limited warranty published by Graco, Graco will, for a period of twelve months from the date of sale, repair or replace any part of the equipment determined by Graco to be defective. This warranty applies only when the equipment is installed, operated and maintained in accordance with Graco's written recommendations.

This warranty does not cover, and Graco shall not be liable for general wear and tear, or any malfunction, damage or wear caused by faulty installation, misapplication, abrasion, corrosion, inadequate or improper maintenance, negligence, accident, tampering, or substitution of non-Graco component parts. Nor shall Graco be liable for malfunction, damage or wear caused by the incompatibility of Graco equipment with structures, accessories, equipment or materials not supplied by Graco, or the improper design, manufacture, installation, operation or maintenance of structures, accessories, equipment or materials not supplied by Graco.

This warranty is conditioned upon the prepaid return of the equipment claimed to be defective to an authorized Graco distributor for verification of the claimed defect. If the claimed defect is verified, Graco will repair or replace free of charge any defective parts. The equipment will be returned to the original purchaser transportation prepaid. If inspection of the equipment does not disclose any defect in material or workmanship, repairs will be made at a reasonable charge, which charges may include the costs of parts, labor, and transportation.

THIS WARRANTY IS EXCLUSIVE, AND IS IN LIEU OF ANY OTHER WARRANTIES, EXPRESS OR IMPLIED, INCLUDING BUT NOT LIMITED TO WARRANTY OF MERCHANTABILITY OR WARRANTY OF FITNESS FOR A PARTICULAR PURPOSE.

Graco's sole obligation and buyer's sole remedy for any breach of warranty shall be as set forth above. The buyer agrees that no other remedy (including, but not limited to, incidental or consequential damages for lost profits, lost sales, injury to person or property, or any other incidental or consequential loss) shall be available. Any action for breach of warranty must be brought within two (2) years of the date of sale.

GRACO MAKES NO WARRANTY, AND DISCLAIMS ALL IMPLIED WARRANTIES OF MERCHANTABILITY AND FITNESS FOR A PARTICULAR PURPOSE, IN CONNECTION WITH ACCESSORIES, EQUIPMENT, MATERIALS OR COMPONENTS SOLD BUT NOT MANUFACTURED BY GRACO. These items sold, but not manufactured by Graco (such as electric motors, switches, hose, etc.), are subject to the warranty, if any, of their manufacturer. Graco will provide purchaser with reasonable assistance in making any claim for breach of these warranties.

In no event will Graco be liable for indirect, incidental, special or consequential damages resulting from Graco supplying equipment hereunder, or the furnishing, performance, or use of any products or other goods sold hereto, whether due to a breach of contract, breach of warranty, the negligence of Graco, or otherwise.

FOR GRACO CANADA CUSTOMERS

The Parties acknowledge that they have required that the present document, as well as all documents, notices and legal proceedings entered into, given or instituted pursuant hereto or relating directly or indirectly hereto, be drawn up in English. Les parties reconnaissent avoir convenu que la rédaction du présente document sera en Anglais, ainsi que tous documents, avis et procédures judiciaires exécutés, donnés ou intentés, à la suite de ou en rapport, directement ou indirectement, avec les procédures concernées.

Graco Information

For the latest information about Graco products, visit www.graco.com.

For patent information, see www.graco.com/patents.

TO PLACE AN ORDER, contact your Graco distributor or call 1-800-690-2894 to identify the nearest distributor.

*All written and visual data contained in this document reflects the latest product information available at the time of publication.
Graco reserves the right to make changes at any time without notice.*

For patent information, see www.graco.com/patents.

Original instructions. This manual contains English. MM 332156

Graco Headquarters: Minneapolis
International Offices: Belgium, China, Japan, Korea

GRACO INC. AND SUBSIDIARIES • P.O. BOX 1441 • MINNEAPOLIS MN 55440-1441 • USA

Copyright 2012, Graco Inc. All Graco manufacturing locations are registered to ISO 9001.

www.graco.com

Revision B August 2014