

Programmable Skipline Controller for RoadLazer™ RoadPak™ Line Striping System

3A1215D
EN

- For the application of road marking reflective materials -
- For professional use only -

Model 24F472 - Controller Only

Model 24G632 - Controller, Cable, Remote Switch, and Bracket



Important Safety Instructions

Read all warnings and instructions in this manual. Save these instructions.

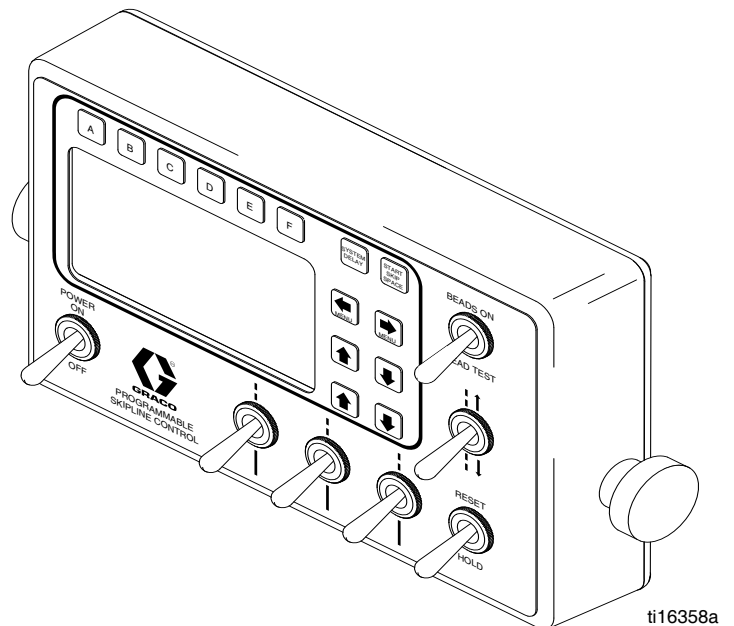

ATTENTION!

To configure the Programmable Skipline Controller to operate with a single wheel tow-behind RoadLazer system (models 231378, 231571 and 231571), see page 7.

Warnings

The following warnings are for the setup, use, grounding, maintenance, and repair of this equipment. The exclamation point symbol alerts you to a general warning and the hazard symbols refer to procedure-specific risks. When these symbols appear in the body of this manual, refer back to these Warnings. Product-specific hazard symbols and warnings not covered in this section may appear throughout the body of this manual where applicable.

WARNING

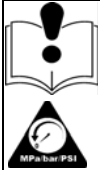





EQUIPMENT MISUSE HAZARD

Misuse can cause death or serious injury.

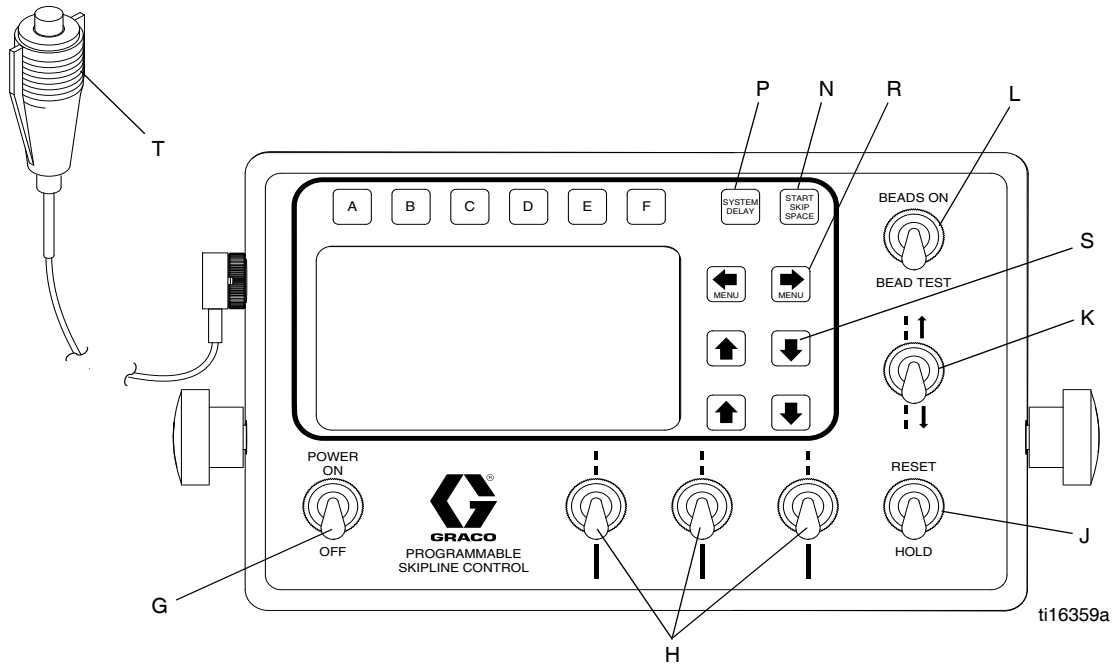
- Do not operate the unit when fatigued or under the influence of drugs or alcohol.
- Do not exceed the maximum working pressure or temperature rating of the lowest rated system component. See **Technical Data** in all equipment manuals.
- Use fluids and solvents that are compatible with equipment wetted parts. See **Technical Data** in all equipment manuals. Read fluid and solvent manufacturer's warnings. For complete information about your material, request MSDS from distributor or retailer.
- Do not leave the work area while equipment is energized or under pressure. Turn off all equipment and follow the **Pressure Relief Procedure** when equipment is not in use.
- Check equipment daily. Repair or replace worn or damaged parts immediately with genuine manufacturer's replacement parts only.
- Do not alter or modify equipment.
- Use equipment only for its intended purpose. Call your distributor for information.
- Route hoses and cables away from traffic areas, sharp edges, moving parts, and hot surfaces.
- Do not kink or over bend hoses or use hoses to pull equipment.
- Keep children and animals away from work area.
- Comply with all applicable safety regulations.

Component Identification and Function



| | Switch / Indicator | Explanation |
|-------|--|---|
| A - F | Menu Controls | Provides menu specific commands as display on LCD screen. Provides skipline paint and cycle distance storage for instant change. Press and hold button to store pattern. |
| G | Power ON/OFF switch | ON enables battery DC power to the Skipline Control. OFF removes power from the Control and grounds the engine spark-plug. Engine can not be started when this switch is in the OFF position. NOTE: This switch is also used to perform an emergency shutdown of the entire system. |
| H | Paint gun switches 1, 2 and 3 | Enables/disables paint guns 1, 2 and 3. Up – skip line. Center – off. Down – continuous line. In skipline mode, a new cycle will be activated each time unless another switch is already activated. |
| J | RESET/HOLD switch | HOLD disables paint guns 1, 2 and 3 and resets the internal cycle counter. RESET resets the internal cycle counter but does not affect continuous line activity. If switch is held in RESET, a new cycle will not begin until the switch is released. |
| K |  switch | Used in conjunction with the arrow switches to adjust the paint line position to match a previously painted line.  allows the dash line to be moved forward.  allows the dash line to be moved closer. The  switch adjusts the position by 1/10' every time it is toggled. |
| L | BEADS ON/BEADS TEST | Enables/disables bead gun BEADS ON (up) – beads start to flow when paint guns start to paint. Center – off. BEADS TEST (down) – continuous bead flow. |
| M | I/O cable port | The control cable connects here and at the striping system. The cable also brings in 12 VDC from the striping system. See page 19. |
| N | Start Skip Space | Choose between starting with paint or space in skip line. |
| P | SYSTEM DELAY ON/OFF | OFF – the paint guns and RESET/HOLD respond immediately. ON – the paint gun switches 1, 2 and 3; and RESET/HOLD switch are delayed by the preset system delay distance. |
| R | MENU arrow switches | Used to switch between menus, adjusting values and resetting values. |
| S | Arrow switches | Used in conjunction with the Skipline Controller's menus to adjust on-screen values. |
| T | Remote control switch | Overrides the RESET/HOLD switch (J) when activated. |

Installation

Mount Programmable Skipline Control

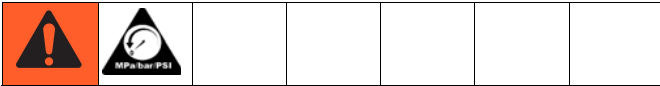

To reduce the risk of serious injury, mount the Skipline Controller where it is easily visible and will not interfere with your view of the road. It should take no longer to look at the controller than it does to look at a rear-view mirror.

Place the Control in a position that is comfortable and easy to use. If you decide to mount the control, mount the 0.50" (13mm) wide mounting bracket to a solid location.

Connect the Control Cable

Clean all connections of dirt, burrs, moisture, et. before connecting them to the system.

Operation

General



To reduce the risk of serious injury, make sure that the Skipline Controller is turned OFF whenever you service any part of the RoadLazer system or leave the RoadLazer unattended.

- All adjusted values remain in memory during power down.
- UP/DOWN: Numbers change faster when button is pressed for more than 2 seconds.
- Standard numbers are adjustable to 1/10 foot.
- Metric numbers are adjustable to 1/50 meter.
- **NOTE:** The controller must be calibrated in the units that you desire to use.
- Paint and cycle length are adjustable from 0.0 to 999.9 feet. or 0.0 to 99.99 meter.
- Footage counters read out to 999,999.
- BEAD ON/OFF and PAINT ON/OFF delays are adjustable.
- Pump output constant is adjustable from 0.0000 to 0.9999 gallons (liters)/stroke.

Menus

Information Readout (Startup/Main Menu)

Measuring Counter: Resets every time HOLD/RESET is activated.

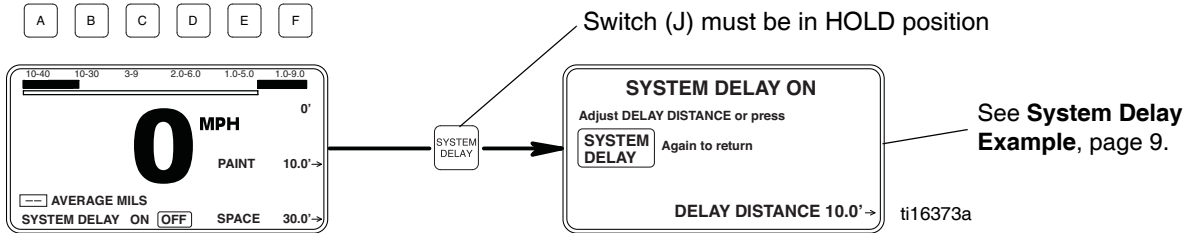

The First Menu is used to set the paint length of a skip line and the frequency of that length.

1. Set paint length with adjacent arrows.
2. Set cycle length with adjacent arrows.

AVERAGE MILS (MIC): Continuously displays line thickness based on accumulated distance and material usage from application totals in next menu.

NOTE: To store current skip line, press and hold any Menu Control button (A - F) to assign the skip line to that button.

Application Totals

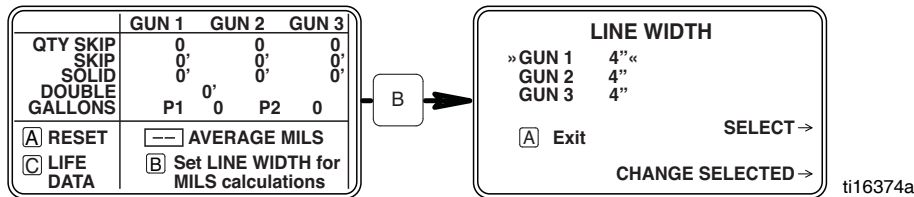

The Counter Menu measures the actual paint distance in feet (meters) from each paint gun. This menu also measures the gallons (liters) of paint sprayed by guns 1, 2, and 3. The average rate is calculated in the row at the bottom of the screen based on line width.*

NOTE: The DOUBLE row indicates when Gun 1 and Gun 2 are on at the same time.

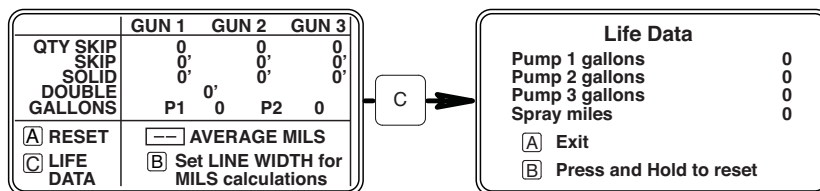

Audible Speed Indicator™

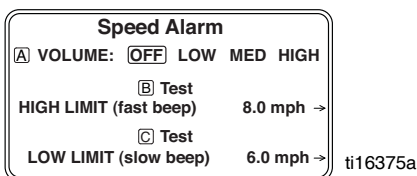

The Speed Alarm Menu allows you to set the speed range (mph) that you would like to work within. The controller will beep rapidly when you exceed the upper limit, and slowly when you fall below the lower limit.

Distance Calibration

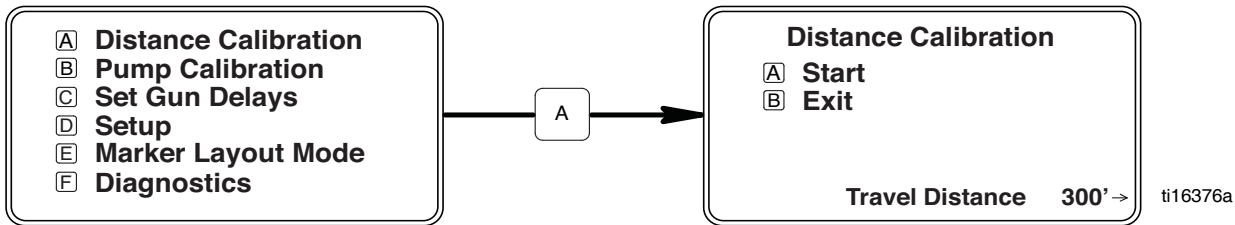

The Distance Calibration Menu is used to calibrate the system against a measured distance (see **Distance Calibration Procedure**, page 9).

1. Use adjacent arrows to enter the length of the measured course.

2. Press at the beginning of the measured course.

3. Press at the end of the measured course.

NOTE: Distance accuracy is based on calibration. Use a good quality measuring tape.

Pump Calibration

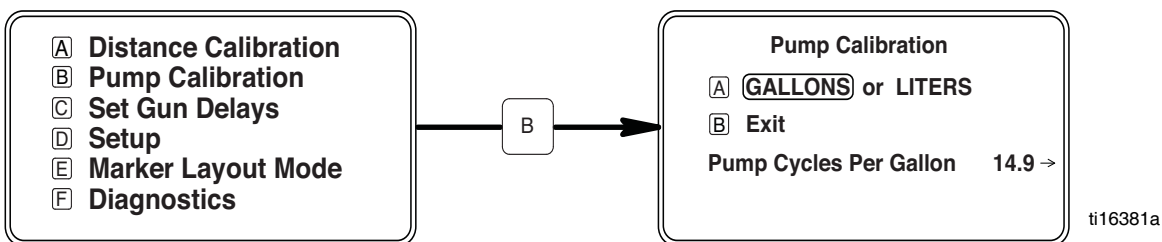

The Pump Calibration Menu is used to adjust the unit of measurement for accurate material usage in gallons or liters.

1. Press to toggle between units for display measurements.

2. Use adjacent arrows to change pump cycles per unit volume (RPS 2900 preset value is 14.9, RoadLazer Tow Behind is 37. Value may need adjusting due to viscosity of material)

Set Gun Delays

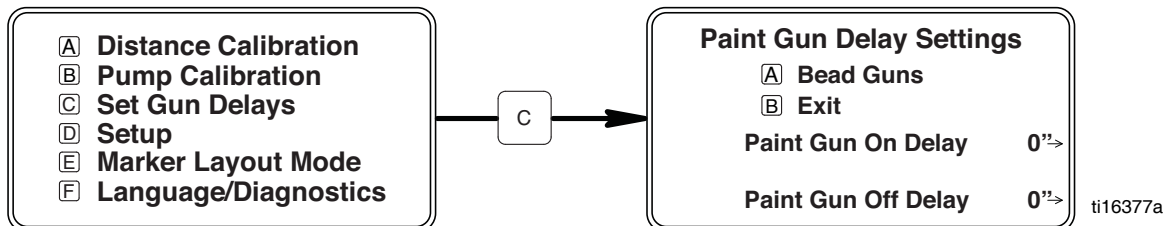

The Set Gun Delays Menu is used to synchronize paint and bead guns in inches (cm). Incrementing value is based on the resolution of the distance sensor.

NOTE: In the event of no distance travel sensing the guns will default to a 1 second delay.

NOTE: Follow on-screen instructions.

1. Press to switch between Bead Gun and Paint Gun.
2. Use adjacent arrows to change ON/OFF Delay Distance.

Setup

- A Distance Calibration
- B Pump Calibration
- C Set Gun Delays
- D Setup
- E Marker Layout Mode
- F Diagnostics

ti16378b

- A Distance Units
- B GALLONS or LITERS
- C Display SPACE or CYCLE
- D Adjust Display Contrast
- E Bead Gun Enable/Disable
- F System Type

Distance Units
Changing units will reset to factory settings

- A English ft/in/mph
- B Metric m/cm/kph
- C Exit

Press A or B to switch English or Metric Units.

A

B

C

D

E

F

Press to choose between GALLONS or LITERS

Press to choose between SPACE or CYCLE to be displayed on the main menu.

Adjust Display Contrast

- A Reset to factory default
- B Exit

Current Setting: Factory Default
CHANGE →

1. Use adjacent arrow to change the display contrast.
2. Press "A" to reset to factory default setting.

Bead Gun Solenoids

- A Solenoid 2 **ENABLE** DISABLED
- B Solenoid 4 **ENABLE** DISABLED
- C Solenoid 6 **ENABLE** DISABLED
- D Exit

This menu allows the user to turn off individual bead gun solenoids.
1. Press "A" to ENABLE/DISABLE solenoid 2.
2. Press "B" to ENABLE/DISABLE solenoid 4.
3. Press "C" to ENABLE/DISABLE solenoid 6.

Configure control to connect to original single wheel tow-behind Roadlazer system?

- A Yes
- B NO - cancel with no changes

Marker Layout Mode

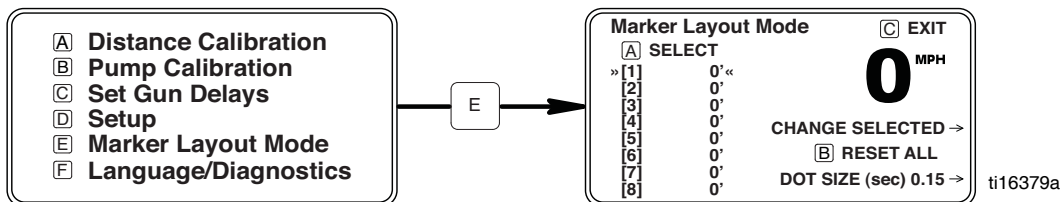

NOTE: To operate Marker Layout Mode, you must be in the Marker Layout Mode Menu. Choose a spray gun and toggle that switch to the skipline setting.

Change Value

Set space sizes up to 8 consecutive measurements. By leaving zeros in any space, Marker Layout Mode will skip to the next measurement in a continuous loop.

DOT Size (sec)

The amount of time the gun will be activated.

NOTE: Lowering system pressure may help produce smaller more precise DOTS.

Marker Layout Mode Example:

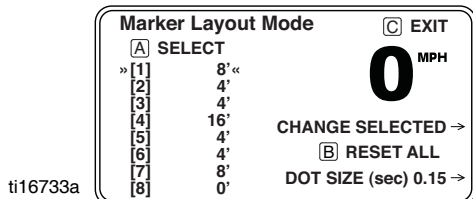
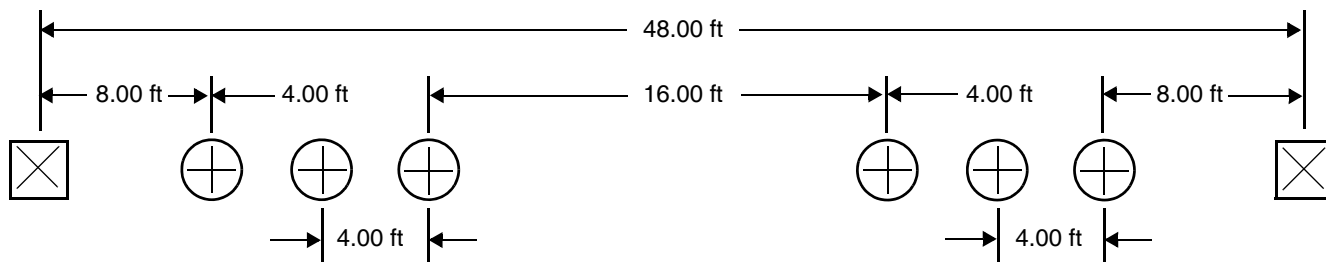

1. Set space sizes.
2. Select DOT SIZE (amount of time gun activates).
3. Select one or more guns in skip line.
4. Activate with HOLD/RESET switch.

Diagnostics

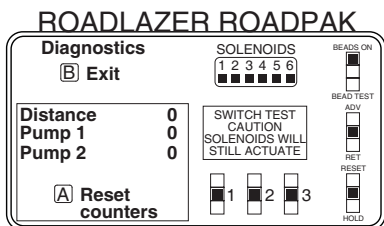

This menu is used to verify inputs from control box switches and sensors on the system, as well as to check if the solenoids are functioning properly. **NOTE:** Solenoid will still be active during the test, which could result in turning the paint and bead guns ON and OFF.

Distance - Counts 50 +/- 2 pulses per revolution of the wheel. Input can be checked by spinning the RoadPak gun arm wheel.

Pump 1 and Pump 2 - Counts one pulse per complete cycle/stroke.

Switches: The darkened box indicates the position of the switch. Toggle each switch individually and the darkened box should move to the new location if functioning properly. If the darkened box does not move, the switch is not functioning properly and will most likely need to be replaced.

Solenoids - Checks for presence of solenoid valve in system. A darkened box indicates solenoid is recognized by the control box. Solenoids will not be recognized with gun arm in up position when mechanical safety switch is used. Solenoid bank will not appear if power is not present.

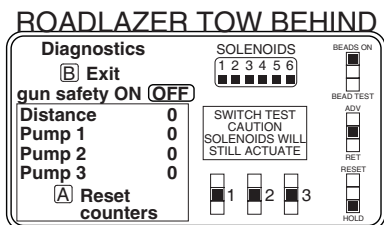

ti17006b

Distance Calibration Procedure

NOTE: Although the RoadLazer is calibrated prior to shipping, the sensor will need to be recalibrated periodically due to wheel wear, and also whenever the gun-arm wheel is replaced.

NOTE: Before recalibrating, ensure that the gun-arm wheel is inflated to 40 psi. and verify the wheel is the proper number of revolutions (see **Diagnostics**, page 8).

1. Measure and tape off an exact distance up to 1000 ft. Suggested distance is 300 ft - 500 ft.

NOTE: Any error made in this measurement causes inaccurate line lengths.

2. Access the Distance Calibration Menu.
3. Use adjacent arrows to enter the length of the measured course.
4. Drive the RoadLazer to the beginning of the measured course. Line up the gun arm wheel exactly on the first mark.
5. Press  button.
6. Drive the RoadLazer in a straight line to the mark at the end of the measured course. Stop with the gun arm wheel exactly on the second mark.

7. Press  button.
8. The system is now calibrated.

System Delay Set-Up

The start and stop of the guns in either solid lines or skiplines may be delayed by a specified distance. The One Operator System Delay™ is designed to make the striping job a one person operation by eliminating the need to look back at the guns to trigger them at the correct time. With the System Delay set, all gun activity is controlled using the mechanical pointer reference point on the road ahead of the vehicle.

1. Enable the system Delay Setup Menu.
2. Sight the mechanical pointer with start of paint stripe (B).
3. Measure delay distance from start of paint stripe to gun. Measure from (A) to (B).
4. Enter measured delay distance with adjacent arrows.

When system delay is ON, all gun switches including HOLD/RESET will be delayed by the distance set in system delay.

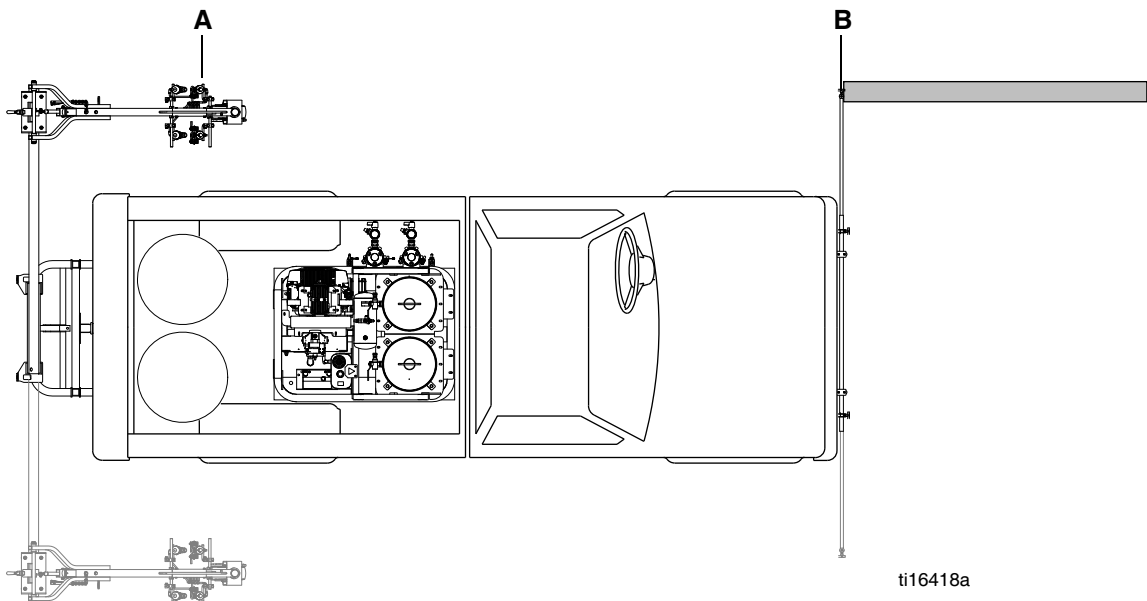

ti16418a

Example: Painting Two Solid Lines with the One-Operator System Delay™ On

1. Turn on System Delay.
2. Set guns 1 and 2 in the solid position and the RESET/HOLD switch in the hold position.

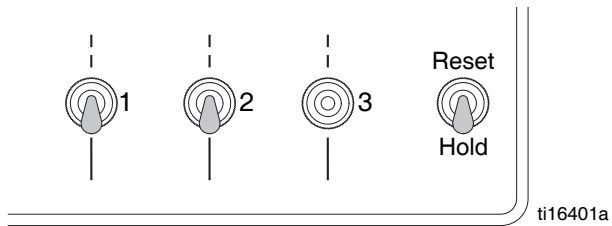

3. Align the mechanical reference point with the beginning of the area to be painted (A).
4. Toggle the REST/HOLD button to center and drive the course. This enables the selected guns to begin painting when Point A is reached.

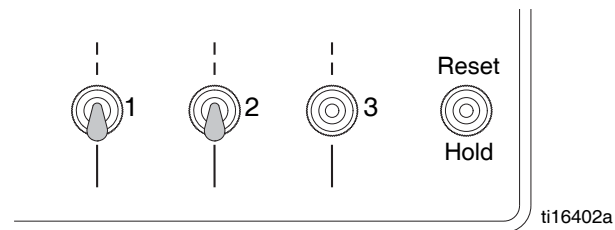

5. When the mechanical pointer reaches the end of the desired course (B), toggle the RESET/HOLD switch to hold. Continue driving until the guns stop spraying.

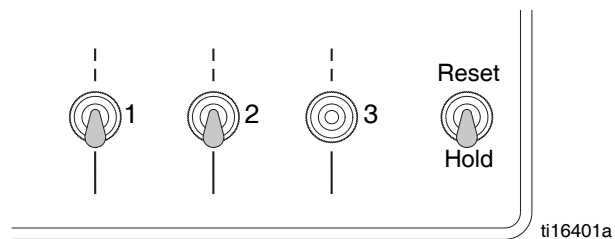

NOTE: For painting single lines, toggle either gun 1 or 2 to Solid, and the unused gun to center.

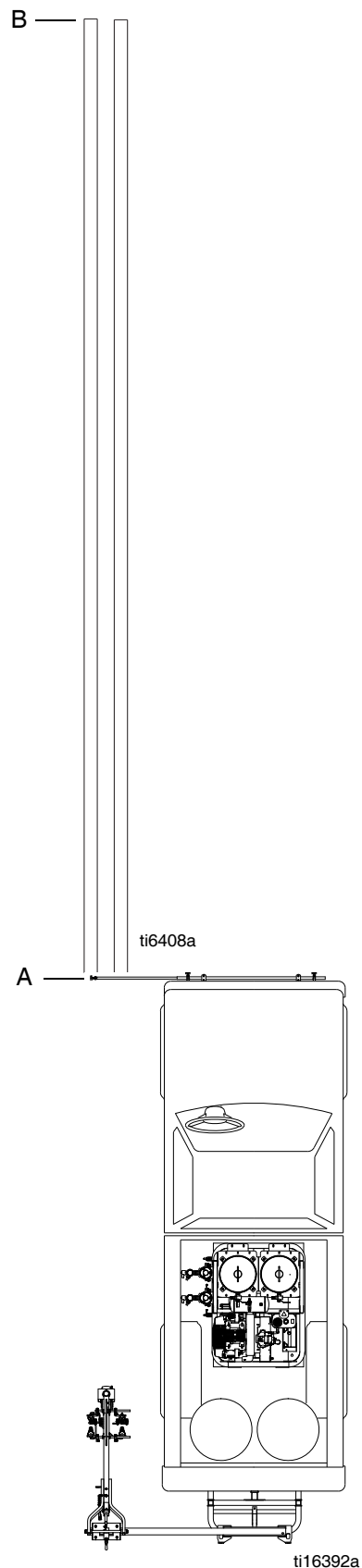

Skipline Applications with One-Operator System Delay™ On

1. Turn on System Delay.
2. Load the cycle and paint length of the skipline to be painted using the First Menu.
3. Align the mechanical pointer with point A.
4. Set gun 1 to Skip, and toggle the HOLD/RELEASE switch to center.

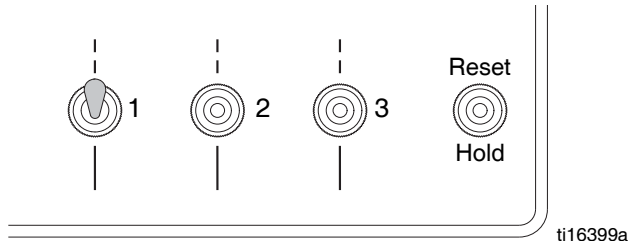

5. When the mechanical point reaches point B, set gun 2 to solid

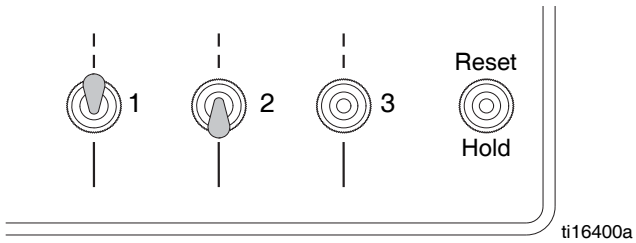

6. When the mechanical point reaches point C, return gun 2 to center.

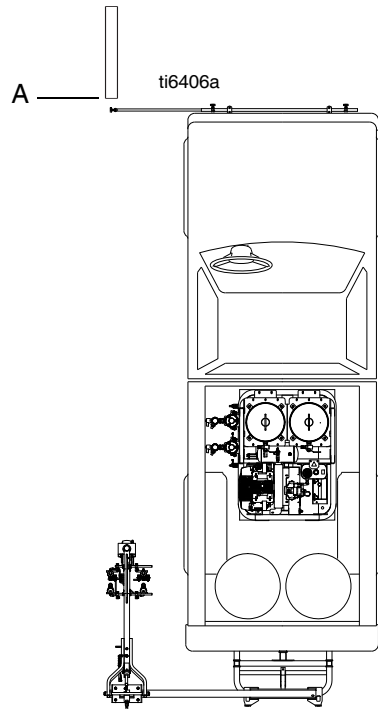
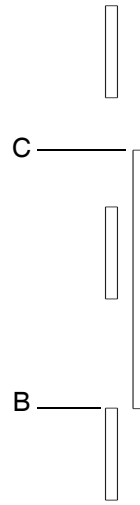
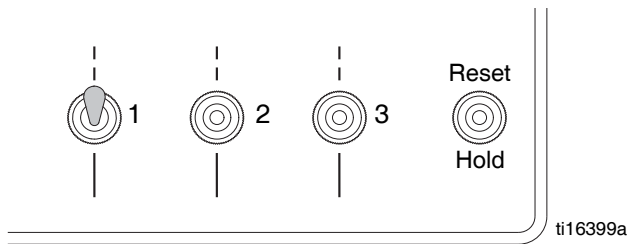

Troubleshooting

| Problem | Cause | Solution |
|--|--|--|
| Control will not turn on. | 12 VDC power supply low, or disconnected. | Connect the I/O cable. Charge the RoadLazer battery. Check the battery connections. |
| Guns will not spray. | Various causes. | Toggle RESET on the controller. Check the paint supply. Check the gun ball valves. See manual 306861. Check the RoadLazer and engine fuses. See manual 308611 or 3A1214 and separate engine manual. |
| MPH readout reads zero, or inconsistent reading. | Improper sensor alignment. | Sensor should be .03 in. from the timing gear, and centered. |
| Glass beads miss a portion of a stripe when turned on. | Paint and bead gun delays not set properly. | Adjust Paint and Bead Gun Delay values. |
| Glass beads stay on longer than the paint guns, wasting beads. | Bead Off Delay is too high. | Lower the Bead Off Delay value. |
| Skipline is longer than the actual programmed distance. | The gun solenoids are taking longer to turn off than to turn on. | Increase the value of the Paint Gun on Delay. |
| Guns will not stop spraying. | The system delay is set to ON while the vehicle is stopped. Gun needle and seat are worn out. | Turn the Skipline Controller's main power switch OFF. Replace. See manual 308613. |

Control Cable Diagram for RoadPak System

** All ground pins MUST be connected to ground
 ++ Input for pull-up/PNP/Sourcing Sensor

| Contact | Description | Action |
|---------|-----------------------------|--------------------|
| 1 | 12 VDC | Supply Voltage |
| 2 | Leave Open - Do Not Connect | |
| 3 | Leave Open - Do Not Connect | |
| 4 | Sensor, pump (1) | Input |
| 5 | Sensor, pump (2) | Input |
| 6 | Paint Gun (1) Solenoid 1 | Output (1 amp Max) |
| 7 | Paint Gun (2) Solenoid 3 | Output (1 amp Max) |
| 8 | Paint Gun (3) Solenoid 5 | Output (1 amp Max) |
| 9 | Bead Gun (1) Solenoid 2 | Output (1 amp Max) |
| 10 | Bead Gun (2) Solenoid 4 | Output (1 amp Max) |
| 11 | Bead Gun (3) Solenoid 6 | Output (1 amp Max) |
| 12 | Engine Shutdown (ground) | |
| 13 | Ground ** | |
| 14 | Ground ** | |
| 15 | Ground ** | |
| 16 | Sensor Distance | Input |
| 17 | Ground ** | |
| 18 | Leave Open - Do not connect | |

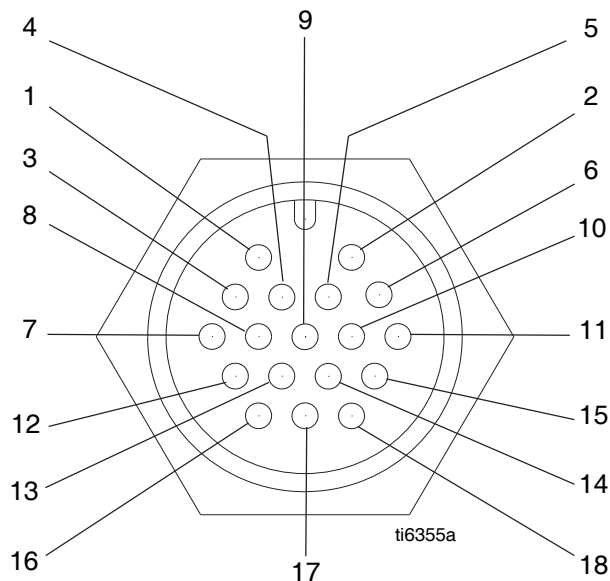

Alternative Pin Arrangement for OEM Applications

NOTE: Pin 18 must be grounded to activate this configuration.

| Contact | Description | Action |
|---------|--------------------------|--------------------|
| 1 | 12 VDC | Supply Voltage |
| 2 | Sensor Distance ++ | Input ++ |
| 3 | Sensor, safety, guns | Input |
| 4 | Sensor, pump (1) | Input |
| 5 | Sensor, pump (2) | Input |
| 6 | Paint Gun (1) Solenoid 1 | Output (1 amp Max) |
| 7 | Paint Gun (2) Solenoid 3 | Output (1 amp Max) |
| 8 | Paint Gun (3) Solenoid 5 | Output (1 amp Max) |
| 9 | Bead Gun (1) Solenoid 2 | Output (1 amp Max) |
| 10 | Bead Gun (2) Solenoid 4 | Output (1 amp Max) |
| 11 | Bead Gun (3) Solenoid 6 | Output (1 amp Max) |
| 12 | Engine Shutdown (ground) | |
| 13 | Ground ** | |
| 14 | Ground ** | |
| 15 | Ground ** | |
| 16 | Sensor Pump (3) | Input |
| 17 | Ground ** | |
| 18 | Ground ** | |

NOTE: All inputs are for open-collector/pull-down/NPN/Sinking Sensors unless otherwise noted.

Parts

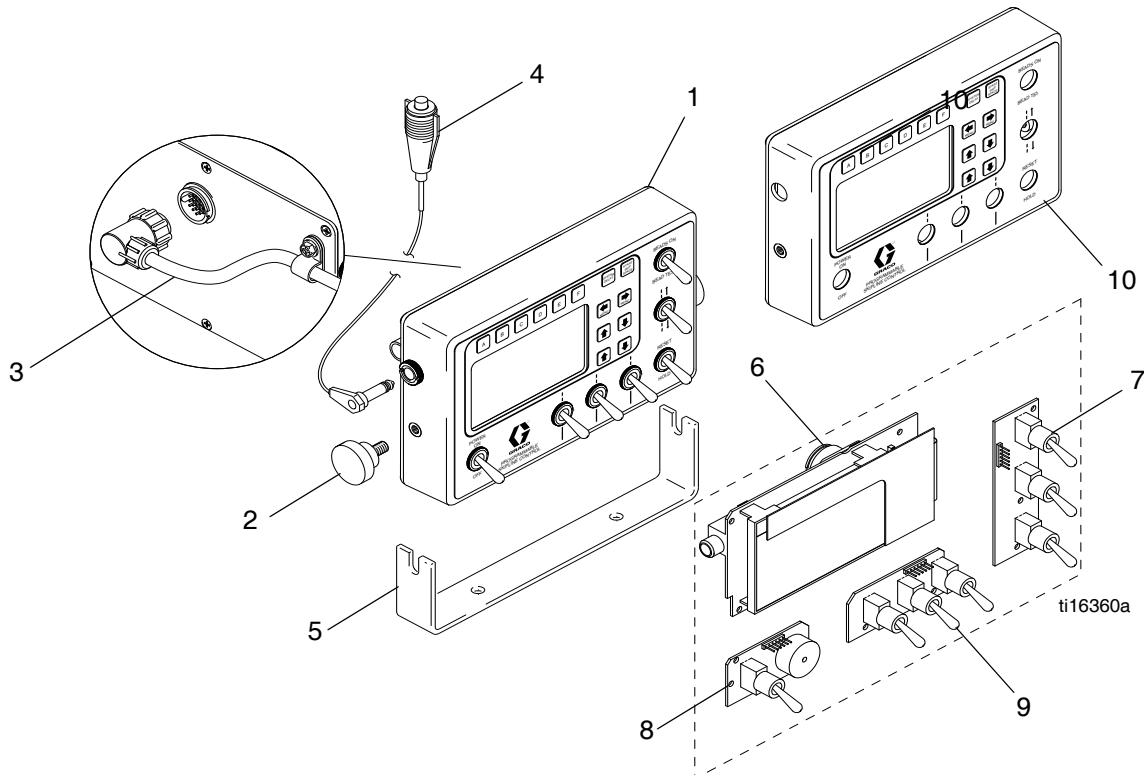

| Ref. | Part | Description | Qty. |
|------|--------|-----------------------------------|------|
| 1 | 24F472 | CONTROLLER, skipline (includes 2) | 1 |
| 2 | | KNOB, mounting | 2 |
| 3 | 24F469 | CABLE, control | 1 |
| 4 | 113617 | SWITCH, remote | 1 |
| 5 | 17V199 | BRACKET, mounting | 1 |
| 6 | 24G720 | KIT, board, display, RoadLazer | 1 |
| 7 | 24G717 | KIT, board, switch, toggle | 1 |
| 8 | 24G719 | KIT, board, switch, power | 1 |
| 9 | 24G718 | KIT, board, control, switch, guns | 1 |
| 10 | 24G721 | KIT, switch, membrane | 1 |

Technical Data

| | |
|-----------------------------------|---|
| Electrical requirements | |
| Control | 12 Vdc |
| Sender input | 12 Vdc |
| Ground | Negative |
| Gun output switching to ground | 2A max |
| Reverse polarity and noisy spikes | Protected |
| Operating speed range | Up to 20 mph (450 pulses/sec) |
| Operating temperature | 32-130° F |
| Weight | 3 |
| Dimensions | 7.25 in. x 4.50 in. x 2.25 in. (184 mm x 114 mm x 57 mm) |

Graco Standard Warranty

Graco warrants all equipment referenced in this document which is manufactured by Graco and bearing its name to be free from defects in material and workmanship on the date of sale to the original purchaser for use. With the exception of any special, extended, or limited warranty published by Graco, Graco will, for a period of twelve months from the date of sale, repair or replace any part of the equipment determined by Graco to be defective. This warranty applies only when the equipment is installed, operated and maintained in accordance with Graco's written recommendations.

This warranty does not cover, and Graco shall not be liable for general wear and tear, or any malfunction, damage or wear caused by faulty installation, misapplication, abrasion, corrosion, inadequate or improper maintenance, negligence, accident, tampering, or substitution of non-Graco component parts. Nor shall Graco be liable for malfunction, damage or wear caused by the incompatibility of Graco equipment with structures, accessories, equipment or materials not supplied by Graco, or the improper design, manufacture, installation, operation or maintenance of structures, accessories, equipment or materials not supplied by Graco.

This warranty is conditioned upon the prepaid return of the equipment claimed to be defective to an authorized Graco distributor for verification of the claimed defect. If the claimed defect is verified, Graco will repair or replace free of charge any defective parts. The equipment will be returned to the original purchaser transportation prepaid. If inspection of the equipment does not disclose any defect in material or workmanship, repairs will be made at a reasonable charge, which charges may include the costs of parts, labor, and transportation.

THIS WARRANTY IS EXCLUSIVE, AND IS IN LIEU OF ANY OTHER WARRANTIES, EXPRESS OR IMPLIED, INCLUDING BUT NOT LIMITED TO WARRANTY OF MERCHANTABILITY OR WARRANTY OF FITNESS FOR A PARTICULAR PURPOSE.

Graco's sole obligation and buyer's sole remedy for any breach of warranty shall be as set forth above. The buyer agrees that no other remedy (including, but not limited to, incidental or consequential damages for lost profits, lost sales, injury to person or property, or any other incidental or consequential loss) shall be available. Any action for breach of warranty must be brought within two (2) years of the date of sale.

GRACO MAKES NO WARRANTY, AND DISCLAIMS ALL IMPLIED WARRANTIES OF MERCHANTABILITY AND FITNESS FOR A PARTICULAR PURPOSE, IN CONNECTION WITH ACCESSORIES, EQUIPMENT, MATERIALS OR COMPONENTS SOLD BUT NOT MANUFACTURED BY GRACO. These items sold, but not manufactured by Graco (such as electric motors, switches, hose, etc.), are subject to the warranty, if any, of their manufacturer. Graco will provide purchaser with reasonable assistance in making any claim for breach of these warranties.

In no event will Graco be liable for indirect, incidental, special or consequential damages resulting from Graco supplying equipment hereunder, or the furnishing, performance, or use of any products or other goods sold hereto, whether due to a breach of contract, breach of warranty, the negligence of Graco, or otherwise.

FOR GRACO CANADA CUSTOMERS

The Parties acknowledge that they have required that the present document, as well as all documents, notices and legal proceedings entered into, given or instituted pursuant hereto or relating directly or indirectly hereto, be drawn up in English. Les parties reconnaissent avoir convenu que la rédaction du présente document sera en Anglais, ainsi que tous documents, avis et procédures judiciaires exécutés, donnés ou intentés, à la suite de ou en rapport, directement ou indirectement, avec les procédures concernées.

Graco Information

For the latest information about Graco products, visit www.graco.com.

TO PLACE AN ORDER, contact your Graco distributor or call 1-800-690-2894 to identify the nearest distributor.

All written and visual data contained in this document reflects the latest product information available at the time of publication. Graco reserves the right to make changes at any time without notice.

For patent information, see www.graco.com/patents

Original instructions. This manual contains English. MM 3A1215

Graco Headquarters: Minneapolis

International Offices: Belgium, China, Japan, Korea

GRACO INC. P.O. BOX 1441 MINNEAPOLIS, MN 55440-1441

Copyright 2010, Graco Inc. is registered to ISO 9001

www.graco.com

Revised D, December 2017