



# Python<sup>®</sup> XL Series Pumps

Pneumatically Operated Pumps for Chemical Injection



PROVEN QUALITY. LEADING TECHNOLOGY.

# Python® XL Pneumatically Operated Pumps

## Features and Benefits

Python XL series pumps are ideal for wells with low gas pressure. Capable of operating up to 12,000 psi, the pumps are easy to operate and include an air motor with the same proven technology that Graco offers in other product lines. Plus the Python XL's extreme duty plungers (Chromex™ and ceramic coated), seals and air valves are designed for years of operation before replacement.

### Ease of serviceability

- Modular air valve design
- Removable pilot valve
- Pump lowers are interchangeable with other Python XL models
- Plunger packings can be replaced in 10 minutes or less

### Highest technology air motor on the market

- Only requires a minimum of 15 psi to operate pump
- Low air/gas consumption for increased efficiency
- Muffler provides low operation noise levels
- Proven Graco® Merkur® air motor technology

### Robust and simple design

- 316 SST fluid section/wetted parts
- Three stroke adjustment positions
- HNBR, FKM, FKM ETP, FFKM, and TFE/P plunger packings and check valve seals

### Environmentally friendly

- 97% recoverable exhaust gas
- Reduced fugitive methane emissions

#### Needle/Blow Off Valve

Helps control pump stroke speed and protects against over-pressure

#### Air Valve

Provides smooth and rapid changeover

#### Pump Stroke Adjustment

Three position stroke adjust

#### Adjustable Packing Seals

For better sealing and increased pump life

#### Pump Plunger Rod

Available in Chromex and ceramic coatings

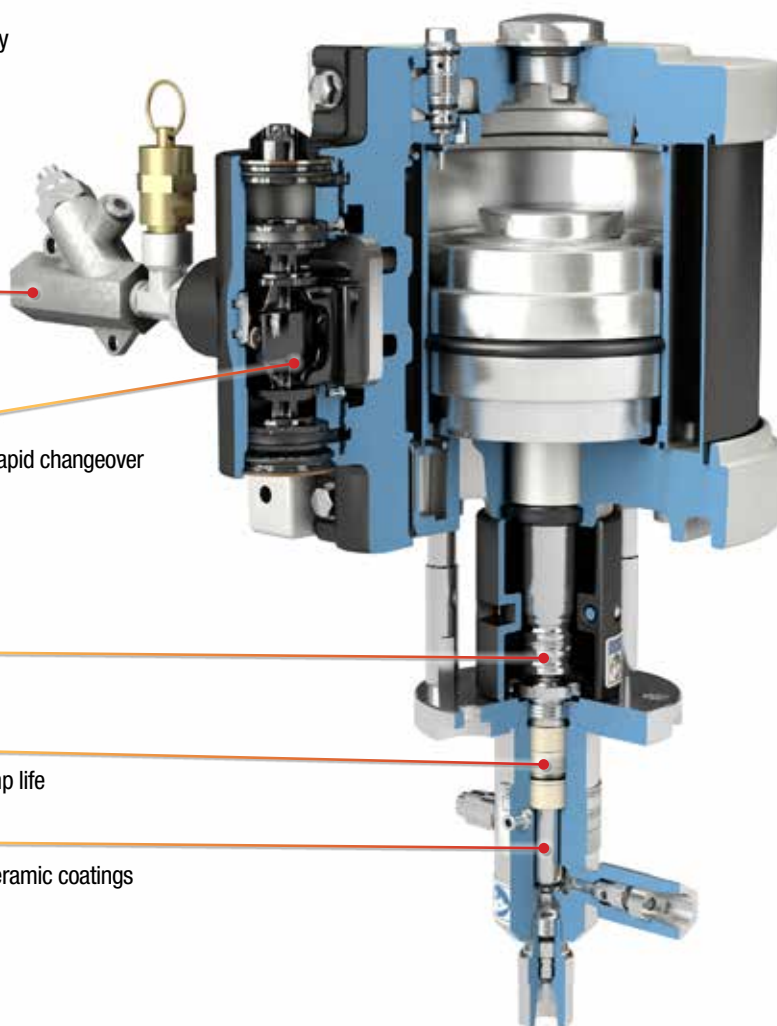

# Selecting the right flows at your given pressures to fit your chemical injection needs.

With three Merkur air motor sizes and up to six different plunger sizes to choose from, the performance table below helps you to quickly identify the right Python XL pump needed for your application.

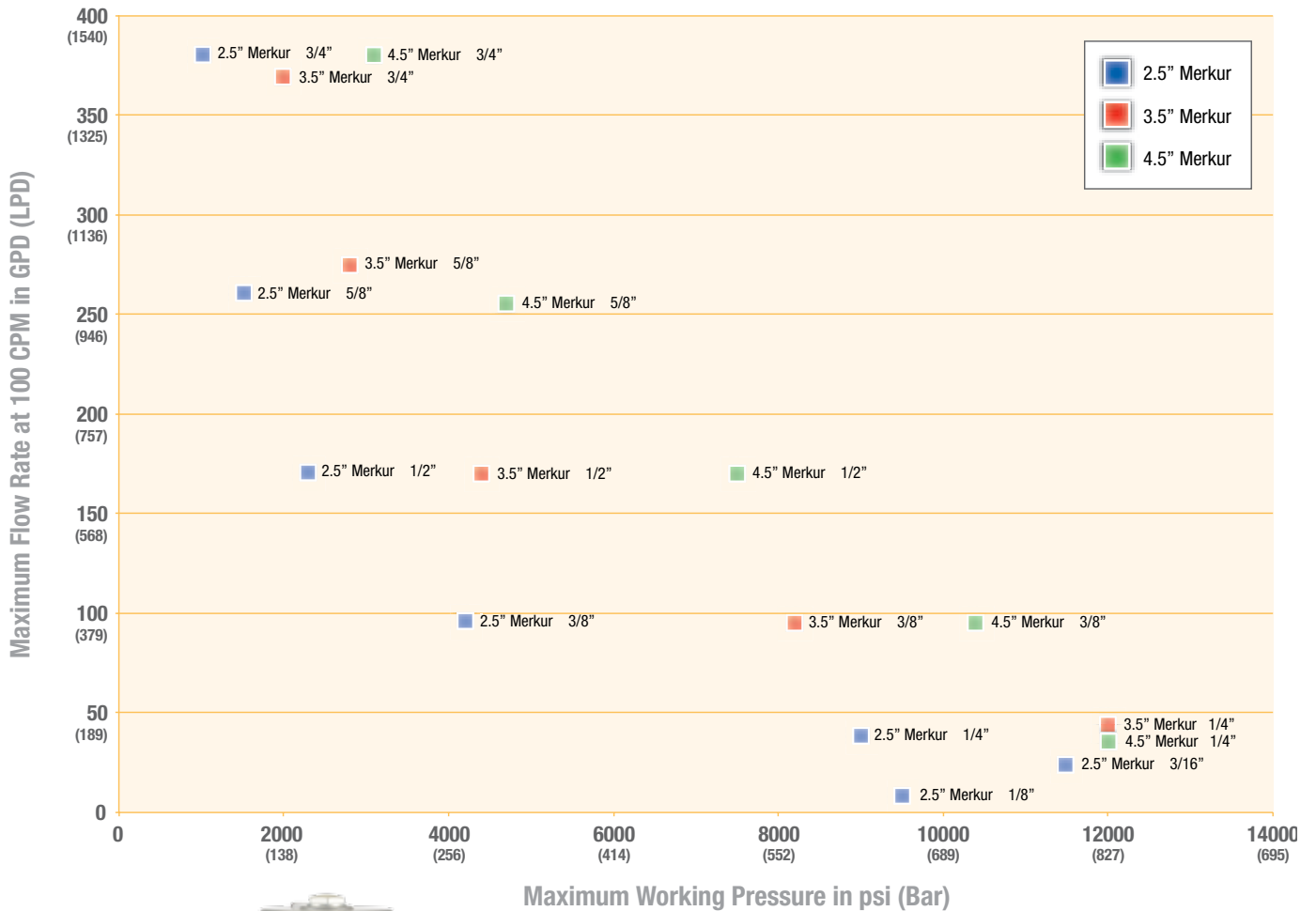

B32274  
Pump stand kit

# Ordering Information



GRACO Python XL Pneumatic Pump Model Numbers 2.5"							
Seals / Plunger Size	1/8"	3/16"	1/4"	3/8"	1/2"	5/8"	3/4"
<b>Python XL, Chromex Coated Plungers (CE Certified)</b>							
FKM	A25250	A25255	A25200	A25201	A25202	A25203	A25204
FKM-ETP	A25251	A25256	A25205	A25206	A25207	A25208	A25209
HNBR	A25252	A25257	A25210	A25211	A25212	A25213	A25214
FFKM	A25253	A25258	A25215	A25216	A25217	A25218	A25219
TFE/P	A25254	A25259	A25240	A25241	A25242	A25243	A25244
<b>Python XL, Ceramic Coated Plungers (CE Certified)</b>							
FKM	A25260	A25265	A25220	A25221	A25222	A25223	A25224
FKM-ETP	A25261	A25266	A25225	A25226	A25227	A25228	A25229
HNBR	A25262	A25267	A25230	A25231	A25232	A25233	A25234
FFKM	A25263	A25268	A25235	A25236	A25237	A25238	A25239
TFE/P	A25264	A25269	A25245	A25246	A25247	A25248	A25249
<b>Python XL, Chromex Coated Plungers (ATEX Certified)</b>							
FKM	A25550	A25555	A25500	A25501	A25502	A25503	A25504
FKM-ETP	A25551	A25556	A25505	A25506	A25507	A25508	A25509
HNBR	A25552	A25557	A25510	A25511	A25512	A25513	A25514
FFKM	A25553	A25558	A25515	A25516	A25517	A25518	A25519
TFE/P	A25554	A25559	A25540	A25541	A25542	A25543	A25544
<b>Python XL, Ceramic Coated Plungers (ATEX Certified)</b>							
FKM	A25560	A25565	A25520	A25521	A25522	A25523	A25524
FKM-ETP	A25561	A25566	A25525	A25526	A25527	A25528	A25529
HNBR	A25562	A25567	A25530	A25531	A25532	A25533	A25534
FFKM	A25563	A25568	A25535	A25536	A25537	A25538	A25539
TFE/P	A25564	A25569	A25545	A25546	A25547	A25548	A25549

Common Pump Parts and Kits Ordering Information			
Kit No.	Item Description	Kit No.	Item Description
B32274	Stand Leg Kit	B32191	Priming Bleed Valve, low pressure
B32272	Wall Bracket 2.5", 3.5" Merkur	B32250	Priming Bleed Valve, high pressure
B32253	Needle Valve Kit (110 psi safety valve)	B32273	Air Motor Tie Rod

For additional parts and kits, refer to Python XL instruction manual 3A3948, pages 36, 37, 38 and 43



B32302  
Pump Lower Kit  
1/2" Chromex Plunger



B32256  
1/2" Chromex Plunger



B32270  
Larger Adapter  
Plate Kit



B32264  
1/4" Packing Nut Kit



B32266  
1/2" Packing Nut Kit

## Key Points

- All pumps feature 1/4 in. npt(f) inlet connections.
- Kit B32240 can be used to convert an HF4 outlet connection to a 1/4 in. npt(f) for applications at or under 10,000 psi (689 bar).



GRACO Python XL Pneumatic Pump Model Numbers 3.5"					
Seals / Plunger Size	1/4"	3/8"	1/2"	5/8"	3/4"
<b>Python XL, Chromex Coated Plungers (CE Certified)</b>					
FKM	A25300	A25301	A25302	A25303	A25304
FKM-ETP	A25305	A25306	A25307	A25308	A25309
HNBR	A25310	A25311	A25312	A25313	A25314
FFKM	A25315	A25316	A25317	A25318	A25319
TFE/P	A25380	A25381	A25382	A25383	A25384
<b>Python XL, Ceramic Coated Plungers (CE Certified)</b>					
FKM	A25320	A25321	A25322	A25323	A25324
FKM-ETP	A25325	A25326	A25327	A25328	A25329
HNBR	A25330	A25331	A25332	A25333	A25334
FFKM	A25335	A25336	A25337	A25338	A25339
TFE/P	A25385	A25386	A25387	A25388	A25389
<b>Python XL, Chromex Coated Plungers (ATEX Certified)</b>					
FKM	A25340	A25341	A25342	A25343	A25344
FKM-ETP	A25345	A25346	A25347	A25348	A25349
HNBR	A25350	A25351	A25352	A25353	A25354
FFKM	A25355	A25356	A25357	A25358	A25359
TFE/P	A25390	A25391	A25392	A25393	A25394
<b>Python XL, Ceramic Coated Plungers (ATEX Certified)</b>					
FKM	A25360	A25361	A25362	A25363	A25364
FKM-ETP	A25365	A25366	A25367	A25368	A25369
HNBR	A25370	A25371	A25372	A25373	A25374
FFKM	A25375	A25376	A25377	A25378	A25379
TFE/P	A25395	A25396	A25397	A25398	A25399

GRACO Python XL Pneumatic Pump Model Numbers 4.5"					
Seals / Plunger Size	1/4"	3/8"	1/2"	5/8"	3/4"
<b>Python XL, Chromex Coated Plungers (CE Certified)</b>					
FKM	A25400	A25401	A25402	A25403	A25404
FKM-ETP	A25405	A25406	A25407	A25408	A25409
HNBR	A25410	A25411	A25412	A25413	A25414
FFKM	A25415	A25416	A25417	A25418	A25419
TFE/P	A25440	A25441	A25442	A25443	A25444
<b>Python XL, Ceramic Coated Plungers (CE Certified)</b>					
FKM	A25420	A25421	A25422	A25423	A25424
FKM-ETP	A25425	A25426	A25427	A25428	A25429
HNBR	A25430	A25431	A25432	A25433	A25434
FFKM	A25435	A25436	A25437	A25438	A25439
TFE/P	A25445	A25446	A25447	A25448	A25449
<b>Python XL, Chromex Coated Plungers (ATEX Certified)</b>					
FKM	A25800	A25801	A25802	A25803	A25804
FKM-ETP	A25805	A25806	A25807	A25808	A25809
HNBR	A25810	A25811	A25812	A25813	A25814
FFKM	A25815	A25816	A25817	A25818	A25819
TFE/P	A25840	A25841	A25842	A25843	A25844
<b>Python XL, Ceramic Coated Plungers (ATEX Certified)</b>					
FKM	A25820	A25821	A25822	A25823	A25824
FKM-ETP	A25825	A25826	A25827	A25828	A25829
HNBR	A25830	A25831	A25832	A25833	A25834
FFKM	A25835	A25836	A25837	A25838	A25839
TFE/P	A25845	A25846	A25847	A25848	A25849



# Technical Data

Python XL Chemical Injection Pump		
	US	Metric
Maximum pneumatic inlet pressure	See Instruction Manual	
Maximum fluid working pressure	See Instruction Manual	
Maximum cycle rate	100 cpm	
Environmental temperature range	-40° – 176°F	-40° – 80°C
<b>Noise (dBA)</b>		
2.5 in. Air Motor Sound Power	83.2 dBA	
2.5 in. Air Motor Sound Pressure	76.5 dBA	
3.5 in. Air Motor Sound Power	84.5 dBA	
3.5 in. Air Motor Sound Pressure	77.9 dBA	
4.5 in. Air Motor Sound Power	80.1 dBA	
4.5 in. Air Motor Sound Pressure	70.2 dBA	
<b>Inlet/Outlet Sizes</b>		
Fluid inlet size	1/4 in. npt(f)	
Fluid outlet size (3/8 in., 1/2 in., 5/8 in., and 3/4 in. plungers only)	1/4 in. npt(f)	
Fluid outlet size (1/4 in. plungers only)	HIP HF4	
Prime/bleed size (3/8 in., 1/2 in., 5/8 in., and 3/4 in. plungers only)	10-32 UNF	
Prime/bleed size (1/4 in. plungers only)	1/16 in. npt(f)	
Pneumatic inlet size	1/4 in. npt(f)	
Exhaust fitting size	3/8 in. npt(f)	
<b>Materials of Construction</b>		
Pump/Check Valve Seal Material	See Configuration Chart in manual for seal material. All other packing materials are PEEK and PTFE unless otherwise noted.	
Wetted Parts	See Configuration Chart in manual for plunger material. All other materials are 316 stainless steel unless otherwise noted.	
<b>Weight</b>		
2.5 in. (ALL MODELS)	14.5 lbs.	6.6 kg
3.5 in. (ALL MODELS)	20.0 lbs.	9.1 kg
4.5 in. (ALL MODELS)	29.0 lbs.	13.2 kg

## Configuration Number Matrix

Check the identification plate (ID) for the 12-digit Configuration Number of your pump. Use the following matrix to define the components of your pump. *NOTE: Not all combinations are possible.*

Sample Configuration Number: **PCI-350-25S-XA-0**

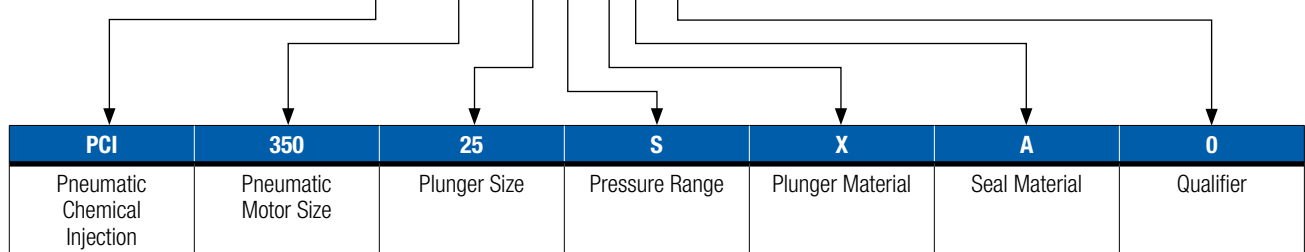

Pneumatic Motor Size		Plunger Size (diameter)		Pressure Range		Plunger Material		Seal Material		Qualifier	
250	2-1/2"	13	1/8"	S	1/4" NPT(F)	X	Chromex	A	FKM	0	None
350	3-1/2"	19	3/16"	H	HIP HF4	C	Ceramic	B	FKMETP	A	ATEX
450	4-1/2"	25	1/4"					C	HNBR		
		38	3/8"					D	FFKM		
		50	1/2"					E	TFE/P		
		63	5/8"								
		75	3/4"								



# Performance Curves

KEY	
Inlet Pressure	
A	= 15 psi (1.0 bar)
B	= 25 psi (1.7 bar)
C	= 50 psi (3.4 bar)
D	= 75 psi (5.2 bar)
E	= 100 psi (6.9 psi)

**3/8" Plunger (PCI-250-38)**

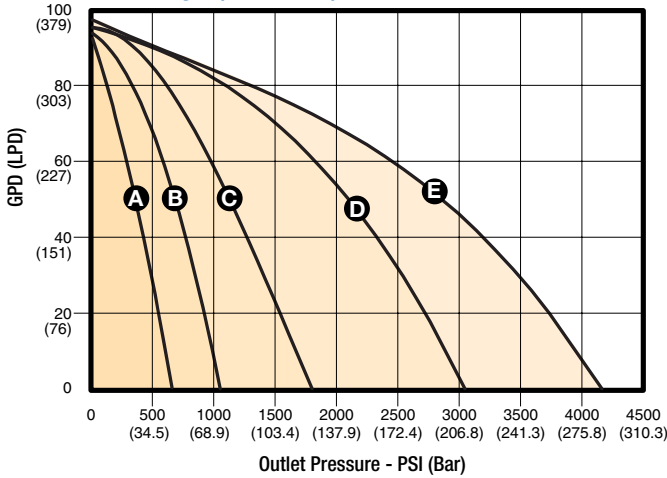

**1/2" Plunger (PCI-250-50)**

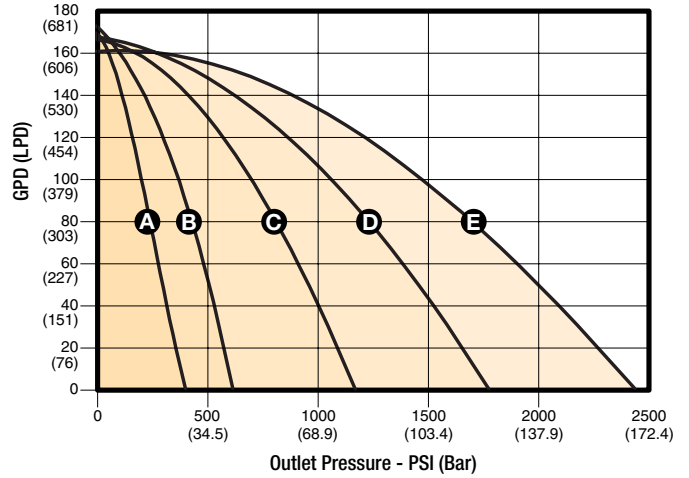

**5/8" Plunger (PCI-350-63)**

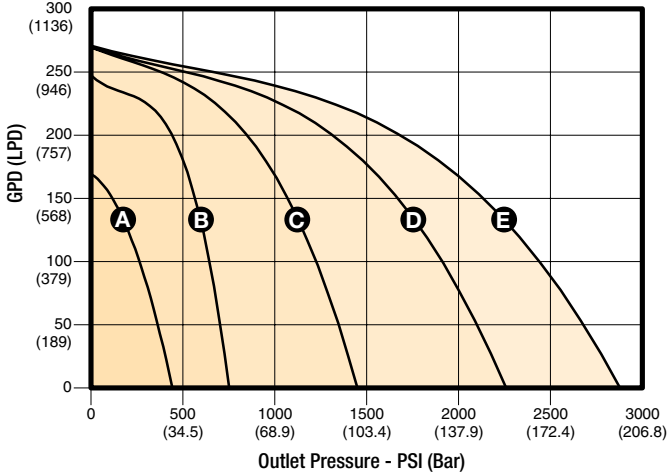

**3/4" Plunger (PCI-350-75)**

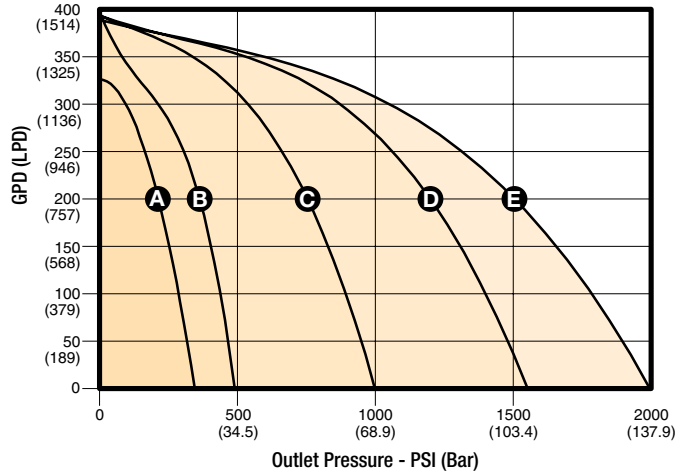

**5/8" Plunger (PCI-450-63)**

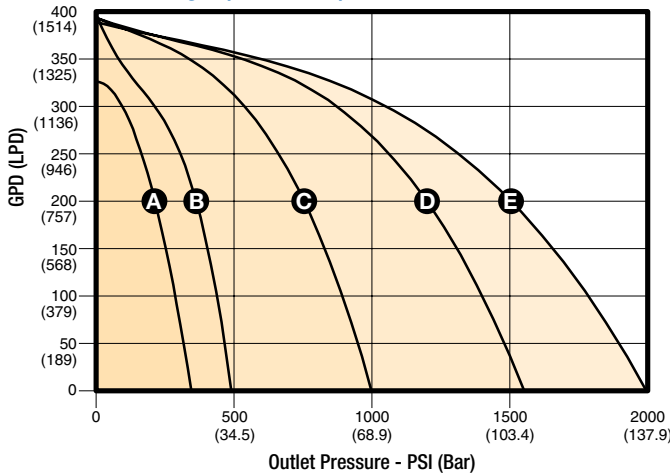

**3/4" Plunger (PCI-450-75)**

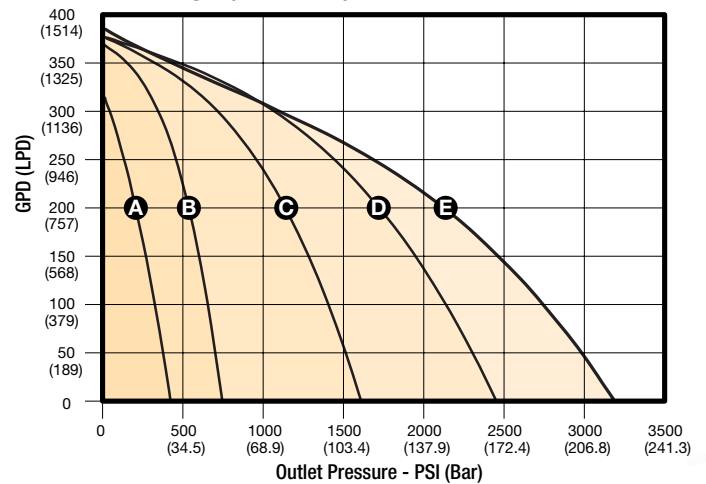

**Note:** performance charts for other plunger sizes are available in the instruction manual.



## ABOUT GRACO

### PROVEN QUALITY. LEADING TECHNOLOGY.

Founded in 1926, Graco is a world leader in fluid handling systems and components. Graco products move, measure, control, dispense and apply a wide range of fluids and viscous materials used in vehicle lubrication, commercial and industrial settings.

The company's success is based on its unwavering commitment to technical excellence, world-class manufacturing and unparalleled customer service. Working closely with qualified distributors, Graco offers systems, products and technology that set the quality standard in a wide range of fluid handling solutions. Graco provides equipment for spray finishing, protective coating, paint circulation, lubrication, and dispensing sealants and adhesives, along with power application equipment for the contractor industry. Graco's ongoing investment in fluid management and control will continue to provide innovative solutions to a diverse global market.

## GRACO LOCATIONS

### MAILING ADDRESS

P.O. Box 1441  
Minneapolis, MN 55440-1441  
Tel: 612-623-6000  
Fax: 612-623-6777

### AMERICAS

#### MINNESOTA

Worldwide Headquarters  
Graco Inc.  
88-11th Avenue N.E.  
Minneapolis, MN 55413

### EUROPE

#### BELGIUM

European Headquarters  
Graco BVBA  
Industrieterrein-Oude Bunders  
Slakweidestraat 31  
3630 Maasmechelen,  
Belgium  
Tel: 32 89 770 700  
Fax: 32 89 770 777

### ASIA PACIFIC

#### AUSTRALIA

Graco Australia Pty Ltd.  
Suite 17, 2 Enterprise Drive  
Bundoora, Victoria 3083  
Australia  
Tel: 61 3 9467 8558  
Fax: 61 3 9467 8559

#### CHINA

Graco Fluid Equipment Co, Ltd  
Shanghai Representative Office  
Building 7  
1029 Zhongshan Road South  
Huangpu District  
Shanghai 200011  
The People's Republic of China  
Tel: 86 21 649 50088  
Fax: 86 21 649 50077

#### INDIA

Graco India Pvt Ltd  
Plot No 295, Udyog Vihar Phase-IV  
Gurugram - 122015 (Haryana)  
India 122001  
Tel: 91 124 6610200  
Fax: 91 124 6610201

#### JAPAN

Graco K.K.  
1-27-12 Hayabuchi  
Tsuzuki-ku  
Yokohama City, Japan 2240025  
Tel: 81 45 593 7300  
Fax: 81 45 593 7301

#### KOREA

Graco Korea Inc.  
38, Samsung 1-ro 1-gil  
Hwaseong-si, Gyeonggi-do,  
18449  
Republic of Korea  
Tel: 82 31 8015 0961  
Fax: 82 31 613 9801

## SALES/ DISTRIBUTION/ SERVICE

Call today for product information or to request a demonstration.

**866-552-1868** or visit us at [www.graco.com/ong](http://www.graco.com/ong)

Graco Inc. is registered to I.S. EN ISO 9001

North America  
Customer Service  
866-552-1868  
Fax 877-340-6427