

GMAX™ II 3900/5900/5900HD/5900 Convertible/7900 TexSpray 5900HD Convertible/7900HD Airless Sprayers

3A0242B
EN

- For Portable Airless Spraying of Architectural Coatings and Paints -

3300 psi (22.8 MPa, 228 bar) Maximum Working Pressure



IMPORTANT SAFETY INSTRUCTIONS

Read all warnings and instructions in this manual. Save these instructions.

| GMAX 3900 | | | | |
|------------------|---------------------------|-----------------|---------------------------|-----------------|
| Model | Hi-Boy Premium (QuikReel) | Hi-Boy Standard | Lo-Boy Premium (QuikReel) | Lo-Boy Standard |
| 248683 | | | | ✓ |
| 248684 | | ✓ | | |
| 249335 | | ✓ | | |
| 258731 | ✓ | | | |
| 258736 | | | ✓ | |
| GMAX 5900 | | | | |
| Model | Hi-Boy Premium (QuikReel) | Hi-Boy Standard | Lo-Boy Premium (QuikReel) | Lo-Boy Standard |
| 248687 | | | | ✓ |
| 248688 | | ✓ | | |
| 258732 | ✓ | | | |
| 258737 | | | ✓ | |
| TexSpray 5900 HD | | | | |
| Model | Hi-Boy Premium (QuikReel) | Hi-Boy Standard | Lo-Boy Premium (QuikReel) | Lo-Boy Standard |
| 258734 | ✓ | | | |
| GMAX 7900 | | | | |
| Model | Hi-Boy Premium (QuikReel) | Hi-Boy Standard | Lo-Boy Premium (QuikReel) | Lo-Boy Standard |
| 248700 | | | | ✓ |
| 248701 | | ✓ | | |
| 258733 | ✓ | | | |
| 258738 | | | ✓ | |
| GMAX 7900 | | | | |
| Model | Hi-Boy Premium (QuikReel) | Hi-Boy Standard | Lo-Boy Premium (QuikReel) | Lo-Boy Standard |
| 258735 | ✓ | | | |

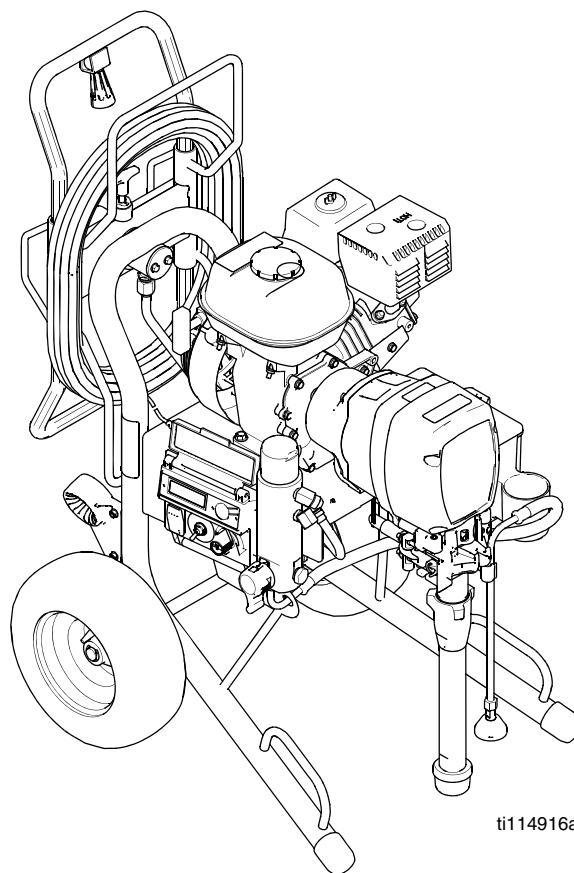











ti114916a

Related Manuals:
Repair 3A0243
Parts 3A0244
Gun 311861

Warning

The following warnings are for the setup, use, grounding, maintenance, and repair of this equipment. The exclamation point symbol alerts you to a general warning and the hazard symbols refer to procedure-specific risks. When these symbols appear in the body of this manual, refer back to these Warnings. Product-specific hazard symbols and warnings not covered in this section may appear throughout the body of this manual where applicable.

|  WARNING | |
|--|--|
|  | <p>FIRE AND EXPLOSION HAZARD</p> <p>Flammable fumes, such as solvent and paint fumes, in work area can ignite or explode. To help prevent fire and explosion:</p> <ul style="list-style-type: none"> • Use equipment only in well ventilated area. • Do not fill fuel tank while engine is running or hot; shut off engine and let it cool. Fuel is flammable and can ignite or explode if spilled on hot surface. • Eliminate all ignition sources; such as pilot lights, cigarettes, portable electric lamps, and plastic drop cloths (potential static arc). • Keep work area free of debris, including solvent, rags and gasoline. • Do not plug or unplug power cords, or turn power or light switches on or off when flammable fumes are present. • Ground all equipment in the work area. See Grounding instructions. • Use only grounded hoses. • Hold gun firmly to side of grounded pail when triggering into pail. • If there is static sparking or you feel a shock, stop operation immediately. Do not use equipment until you identify and correct the problem. • Keep a working fire extinguisher in the work area. |
|  | <p>SKIN INJECTION HAZARD</p> <p>High-pressure fluid from gun, hose leaks, or ruptured components will pierce skin. This may look like just a cut, but it is a serious injury that can result in amputation. Get immediate surgical treatment.</p> <ul style="list-style-type: none"> • Do not spray without tip guard and trigger guard installed. • Engage trigger lock when not spraying. • Do not point gun at anyone or at any part of the body. • Do not put your hand over the spray tip. • Do not stop or deflect leaks with your hand, body, glove, or rag. • Follow the Pressure Relief Procedure when you stop spraying and before cleaning, checking, or servicing equipment. • Tighten all fluid connections before operating the equipment. • Check hoses and couplings daily. Replace worn or damaged parts immediately. |
|  | <p>MOVING PARTS HAZARD</p> <p>Moving parts can pinch, cut or amputate fingers and other body parts.</p> <ul style="list-style-type: none"> • Keep clear of moving parts. • Do not operate equipment with protective guards or covers removed. • Pressurized equipment can start without warning. Before checking, moving, or servicing equipment, follow the Pressure Relief Procedure and disconnect all power sources. |

|  WARNING | |
|--|--|
|  | <p>PRESSURIZED ALUMINUM PARTS HAZARD</p> <p>Use of fluids that are incompatible with aluminum in pressurized equipment can cause serious chemical reaction and equipment rupture. Failure to follow this warning can result in death, serious injury, or property damage.</p> <ul style="list-style-type: none"> Do not use 1,1,1-trichloroethane, methylene chloride, other halogenated hydrocarbon solvents or fluids containing such solvents. Many other fluids may contain chemicals that can react with aluminum. Contact your material supplier for compatibility. |
|  | <p>SUCTION HAZARD</p> <p>Powerful suction could cause serious injury.</p> <ul style="list-style-type: none"> Never place hands near the pump fluid inlet when pump is operating or pressurized. |
|  | <p>CARBON MONOXIDE HAZARD</p> <p>Exhaust contains poisonous carbon monoxide, which is colorless and odorless. Breathing carbon monoxide can cause death.</p> <ul style="list-style-type: none"> Do not operate in an enclosed area. |
|  | <p>TOXIC FLUID OR FUMES HAZARD</p> <p>Toxic fluids or fumes can cause serious injury or death if splashed in the eyes or on skin, inhaled, or swallowed.</p> <ul style="list-style-type: none"> Read MSDS's to know the specific hazards of the fluids you are using. Store hazardous fluid in approved containers, and dispose of it according to applicable guidelines. |
|  | <p>BURN HAZARD</p> <p>Equipment surfaces and fluid that's heated can become very hot during operation. To avoid severe burns:</p> <ul style="list-style-type: none"> Do not touch hot fluid or equipment. |
|  | <p>PERSONAL PROTECTIVE EQUIPMENT</p> <p>You must wear appropriate protective equipment when operating, servicing, or when in the operating area of the equipment to help protect you from serious injury, including eye injury, hearing loss, inhalation of toxic fumes, and burns. This equipment includes but is not limited to:</p> <ul style="list-style-type: none"> Protective eyewear, and hearing protection. Respirators, protective clothing, and gloves as recommended by the fluid and solvent manufacturer |

Component Identification

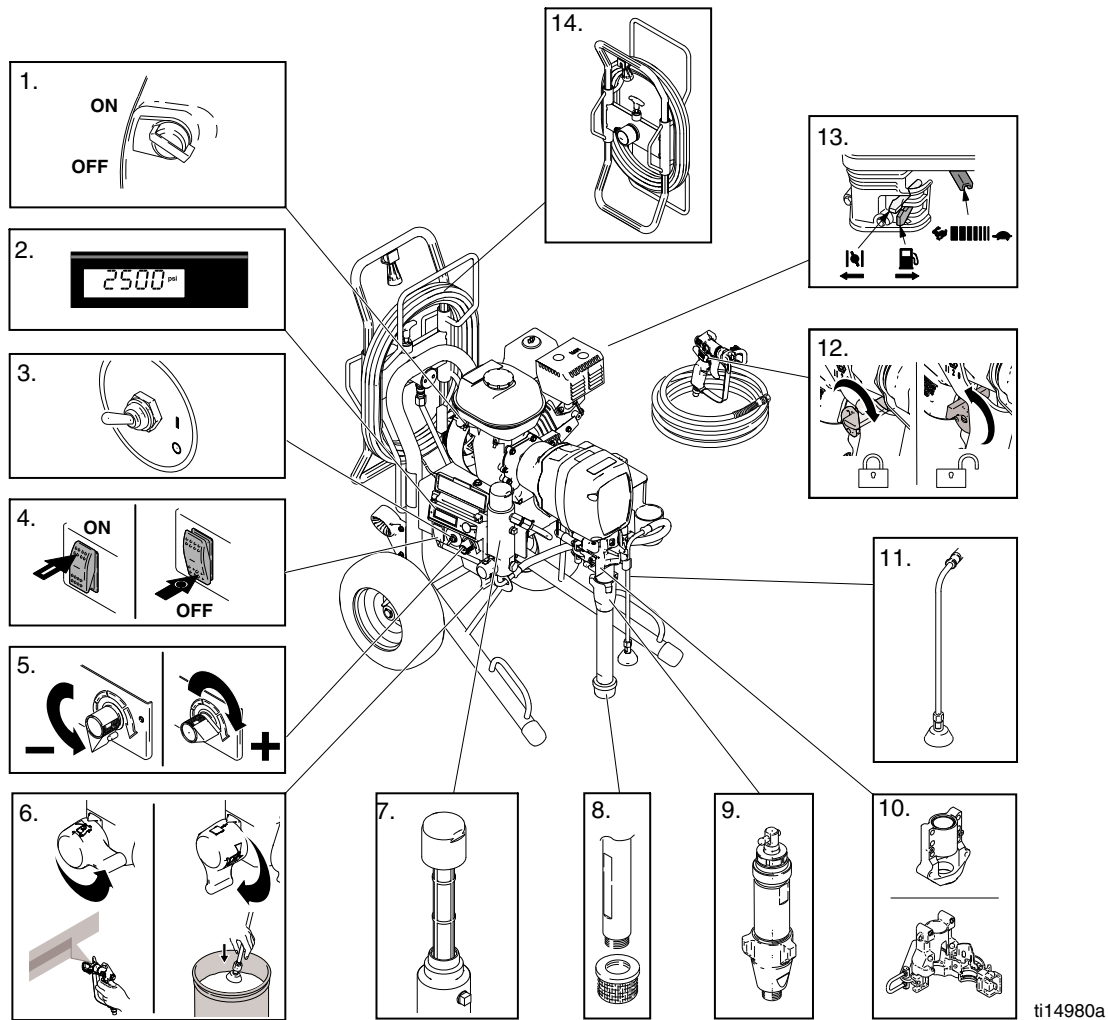

ti14980a

| | |
|----|---------------------------|
| 1 | Engine ON/OFF Switch |
| 2 | Premium Digital Display |
| 3 | WatchDog™ Switch |
| 4 | Pump On/Off Switch |
| 5 | Pressure Control |
| 6 | Prime Valve |
| 7 | Suction Tube Inlet Filter |
| 8 | Strainer |
| 9 | Pump |
| 10 | ProConnect™ |
| 11 | Drain Hose |
| 12 | Trigger Lock |
| 13 | Engine Controls |
| 14 | Hose Reel |

Pressure Relief Procedure



1. Lock gun trigger safety.
2. Turn engine ON/OFF switch to OFF.
3. Move pump switch to OFF and turn pressure control knob fully counterclockwise.
4. Unlock trigger safety. Hold metal part of gun firmly to side of grounded metal pail, and trigger gun to relieve pressure.

5. Lock gun trigger safety.
6. Open pressure drain valve. Leave valve open until ready to spray again.

If you suspect that the spray tip or hose is completely clogged, or that pressure has not been fully relieved after following the steps above, VERY SLOWLY loosen tip guard retaining nut or hose end coupling to relieve pressure gradually, then loosen completely. Now clear tip or hose.

Setup

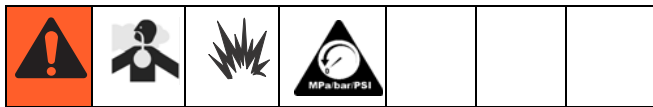

1. **Standard Units Only:** Connect appropriate Graco high-pressure hose to sprayer.
2. **Standard Units Only:** Install whip hose to fluid inlet of spray gun and tighten securely.

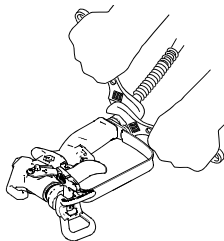

ti14843a

3. Engage gun trigger safety.

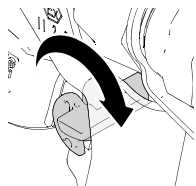

ti13031a

4. When spraying texture, remove inlet strainer and filter bowl screen when spraying materials.

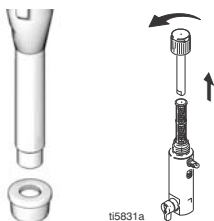

ti5831a

5. Fill throat packing nut with TSL to prevent premature packing wear. Do this each time you spray.

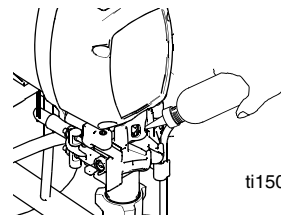

ti15020a

6. Check engine oil level. Add SAE 10W-30 (summer) or 5W-20 (winter), if necessary.



ti5952a

7. Fill fuel tank.

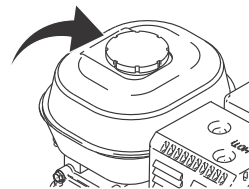

ti5953a

8. Attach sprayer grounding clamp to earth ground.

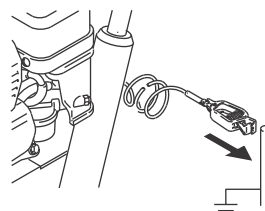

ti5787a

Convertible Models Only:



Change Engine to Motor

1. Disconnect engine power cord.

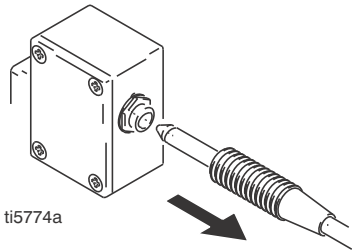

2. Release tension bar.

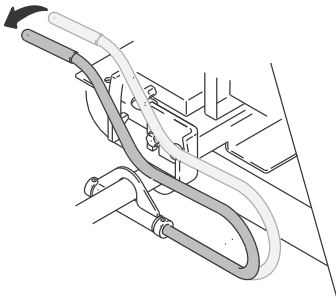

3. Remove engine; tilt and slide back.

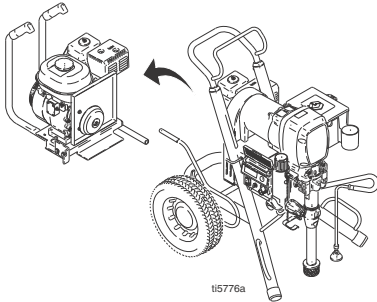

4. Install motor; drop in and push forward.

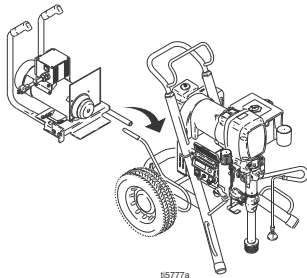

5. Look through side vent holes and ensure drive belt is in motor pulley.

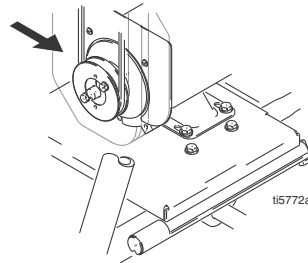

6. Secure motor with tension bar.

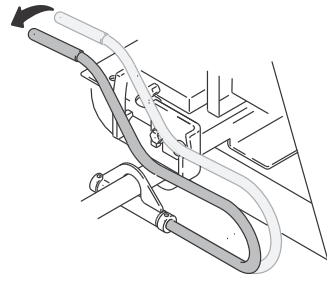

7. Plug in pressure control power cord.

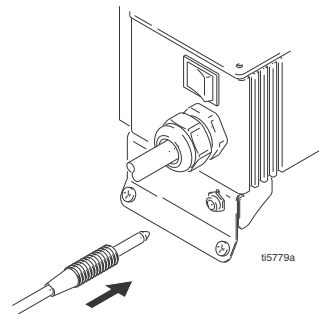

Startup



1. Place suction tube and drain tube in grounded metal pail partially filled with flushing fluid. Attach ground wire to pail and to earth ground.

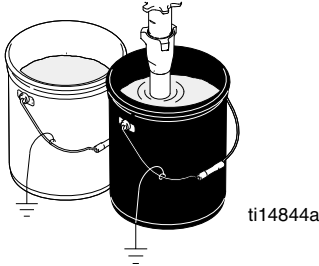

2. Turn prime valve down to DRAIN position. Turn pressure control counterclockwise to lowest pressure.

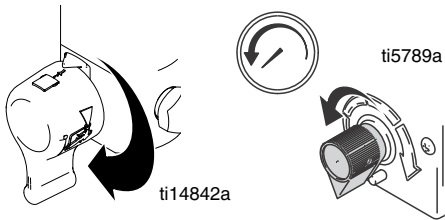

3. Set pump switch OFF.

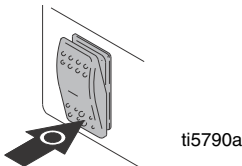

4. Start Engine

- a. Move fuel valve to open.

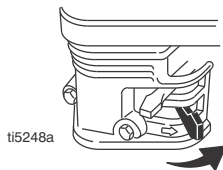

- b. Move choke to closed.

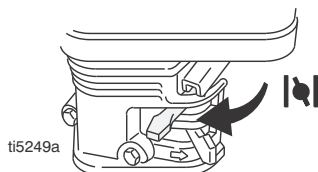

- c. Set throttle to fast.

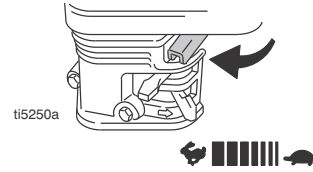

- d. Set engine switch to ON.

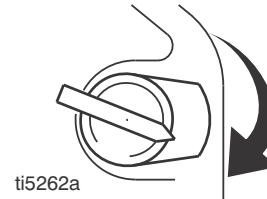

5. Pull rope to start engine.

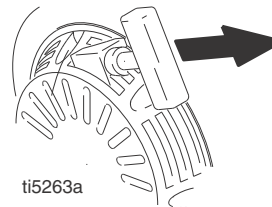

6. Increase pressure enough to start pump stroking and allow fluid to circulate for 15 seconds; turn pressure down and turn prime valve forward to SPRAY position.

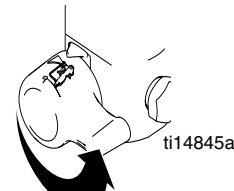
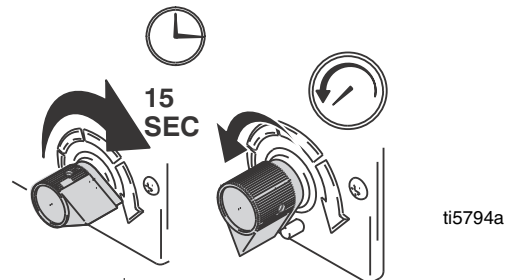

7. Take spray gun trigger safety OFF.



8. Hold gun against grounded metal flushing pail. Trigger gun and increase fluid pressure slowly until pump runs smoothly.

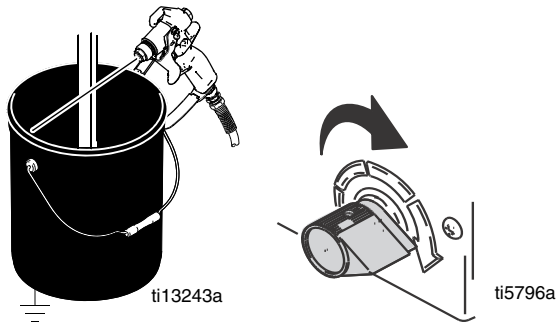

Inspect fittings for leaks. Do not stop leaks with your hand or a rag! If leaks occur, turn sprayer OFF immediately. Perform **Pressure Relief Procedure** steps 1-3, page 5. Tighten leaky fittings. Repeat **Startup** procedure steps 1 - 5. If no leaks, continue to trigger gun until system is thoroughly flushed. Proceed to step 6.

9. Place siphon tube in material pail.

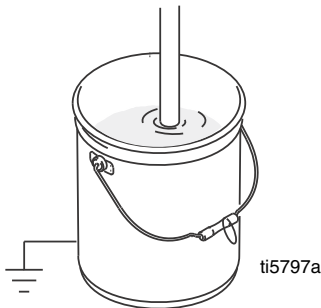

10. Trigger gun again into flushing fluid pail until material appears.

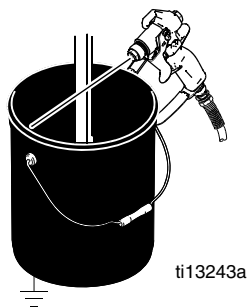

Switch Guard Assembly

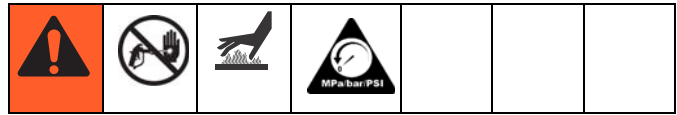

1. Put trigger safety ON. Insert SwitchTip. Insert seat and OneSeal™.

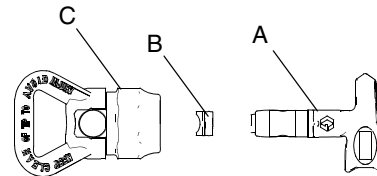

2. Insert SwitchTip.

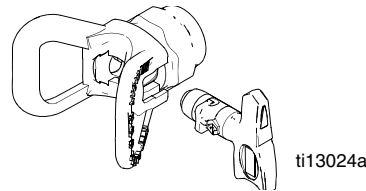

3. Screw assembly onto gun. Tighten.

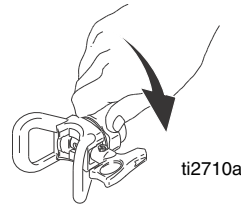

Spray

1. Spray test pattern. Increase pressure to eliminate heavy edges. Use smaller tip size if pressure adjustment can not eliminate heavy edges.

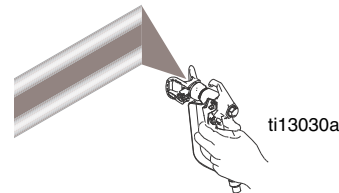

2. Hold gun perpendicular, 10-12 in. (25-30 cm) from surface. Spray back and forth. Overlap by 50%. Trigger gun after moving and release before stopping.

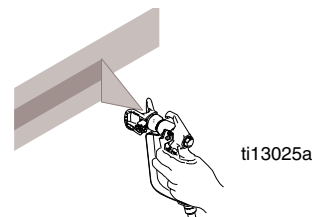

Clearing Tip Clogs

1. Release trigger, put safety ON. Rotate SwitchTip. Take safety OFF. Trigger gun to clear clog. Never point gun at your hand or into a rag!

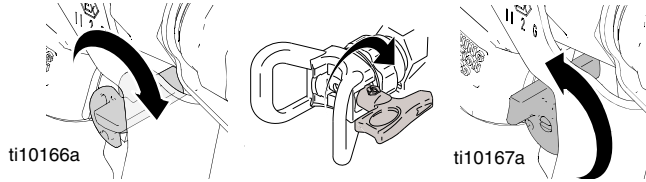

2. Put safety ON. Return SwitchTip to original position. Take safety OFF and continue spraying.

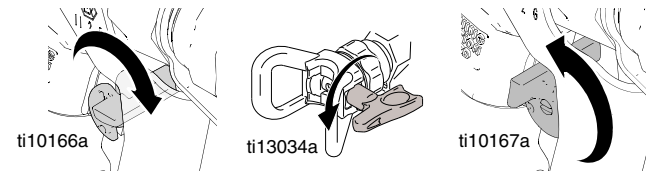

WatchDog™ Protection System (Not Available on All Units)

Pump stops automatically when material pail is empty.

To Activate:

1. Perform **Startup**.
2. Premium units with digital display: Turn WatchDog switch ON and **WD ON** displays. **EMPTY** displays/ flashes and pump stops when Watchdog protection system detects an empty material pail.

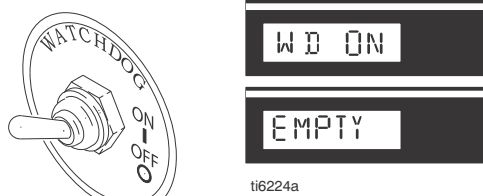

3. Turn WatchDog switch OFF. Add material or reprime sprayer. Turn pump switch OFF and ON to reset WatchDog protection system. Turn WatchDog switch back ON to continue to monitor material level.



Hose Reel

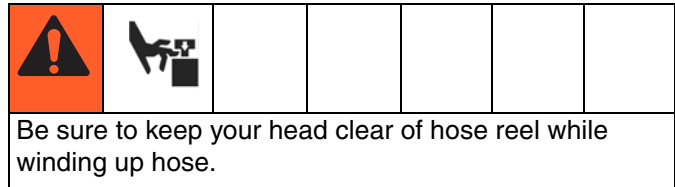

1. Make sure hose is routed through hose guide.

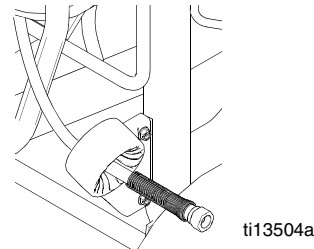

2. Lift and turn pivot lock 90 to unlock hose reel. Pull on hose to remove it from hose reel.

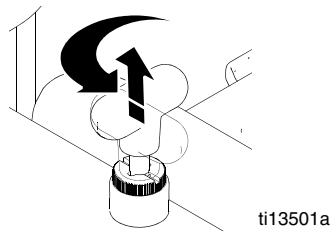

3. Pull reel handle down and turn clockwise to reel in hose.

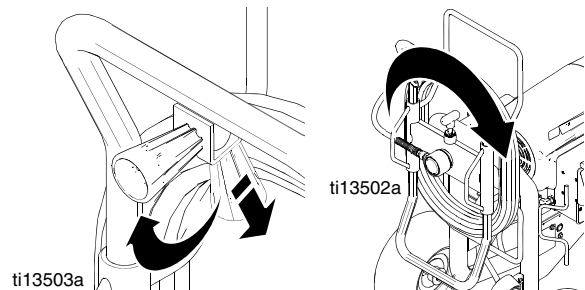

NOTE: The hose reel can be locked into two positions: Usage (A) and Storage (B).

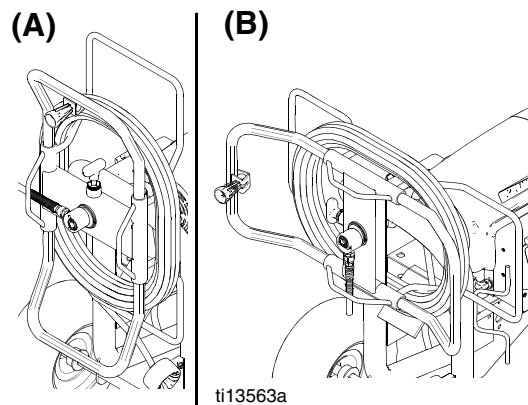

Digital Tracking System

Operation Main Menu

Short press to move to next display. Press and hold (5 seconds) to change units or reset data.

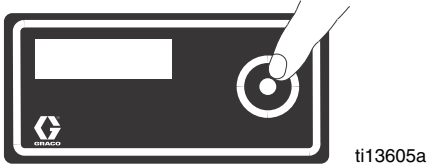

1. Turn pressure to lowest setting. Trigger gun to relieve pressure. Turn prime valve down to DRAIN position.

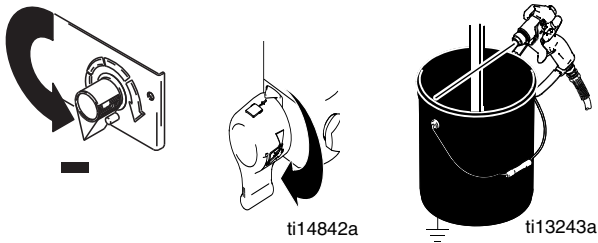

2. Turn power ON. Pressure display appears. Dashes will not appear unless pressure is less than 200 psi (14 bar, 1,4 MPa).

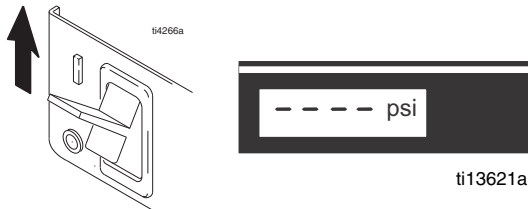

Change Display Units

Press and hold DTS button for 5 seconds to change pressure units (**psi**, **bar**, **MPa**) to desired units. Selection of bar or MPa changes **gallons** to **liters x 10**. To change display units DTS must be in pressure display mode and pressure must be at zero.

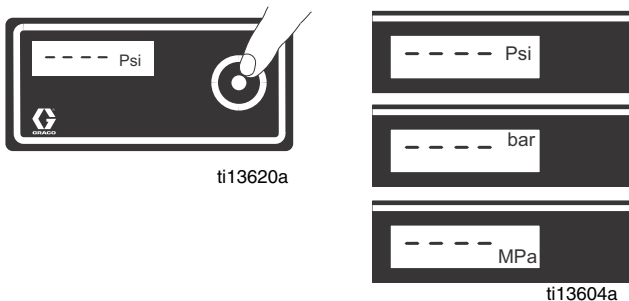

Job Gallons

1. Short press DTS button to move to Job Gallons (or liters x 10).



NOTE: **JOB** scrolls past, then the number of gallons sprayed above 1000 psi (70 bar, 7 MPa) displays.

Lifetime Gallons

1. Short press DTS button to move to Lifetime Gallons (or liters x 10).

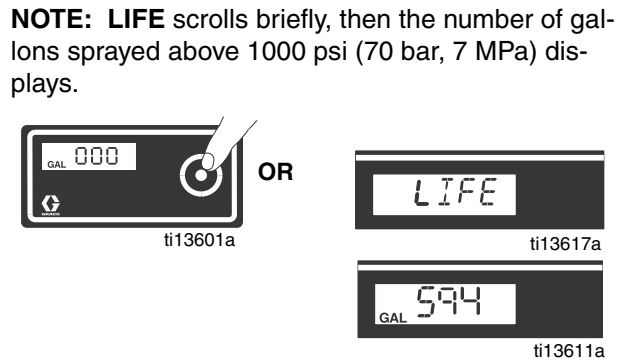

NOTE: **LIFE** scrolls briefly, then the number of gallons sprayed above 1000 psi (70 bar, 7 MPa) displays.

Secondary Menu - Stored Data and WatchDog Pump Protection Modes

1. Perform **Pressure Relief**, steps 1 - 4 if they have not already been done.
2. Turn power switch on while holding DTS button down.

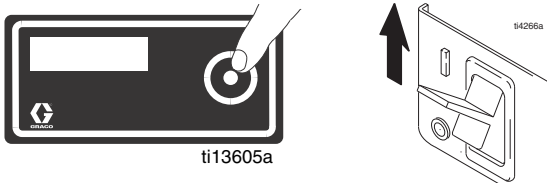

3. The sprayer model briefly displays (e.g. **5900**), **SERIAL NUMBER** scrolls past and then serial number (e.g. 00001) displays.



ti13622a



ti7362a

4. Short press DTS button and **MOTOR ON** scrolls past and then total motor run hours are displayed.



ti13618a



ti13619a

5. Short press DTS button. **LAST ERROR CODE** scrolls by and last error code is displayed; e.g. **E=07**. (Manual 311365).



ti13601a



ti13615a



ti13607a

6. Press and hold DTS button to clear error code to zero.



ti13609a



ti13606a

7. Short press DTS button. **W-DOG** scrolls past then **OFF** displays if watchdog switch is OFF. **ON** displays if Watchdog switch is ON.



ti13608a



ti13626a



ti13614a

8. Press and hold (8 seconds) DTS button to move to WatchDog Trigger % menu. Continue to hold DTS button and Watchdog can be set to trigger at 30, 40, 50, or 60% of current sprayer pressure setting. Release DTS button when desired % is displayed. default is 50%.



ti5820a

9. Short press to move to **SOFTWARE REV.**



ti13613a



ti13623a

Cleanup

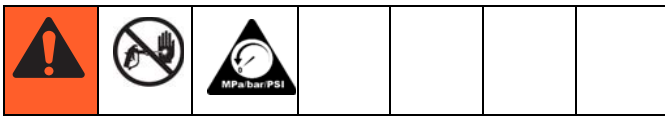

1. Perform **Pressure Relief Procedure** (page 5), steps 1 - 4. Remove siphon tube set from paint and place in flushing fluid. Remove tip guard from gun.

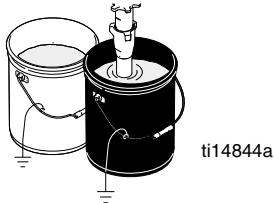

NOTE: Use water for water-base paint, mineral spirits for oil-base paint, or other solvents recommended by manufacturer.

2. Turn power **ON**. Turn prime valve forward to **SPRAY** position.



3. Increase pressure to 1/2. Hold gun against paint pail. Take trigger safety **OFF**. Trigger gun until flushing fluid appears.

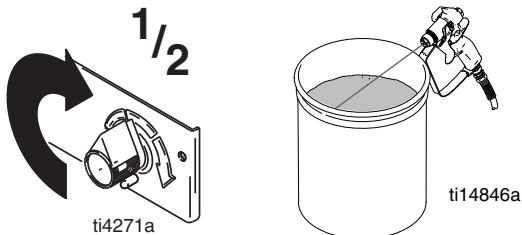

4. Move gun to waste pail, hold gun against pail, trigger gun to thoroughly flush system. Release trigger and put trigger safety **ON**.



5. Turn prime valve down to **DRAIN** position and allow flushing fluid to circulate until flushing fluid appears clear.

6. Turn prime valve forward to **SPRAY** position. Trigger gun into flushing pail to purge fluid from hose.

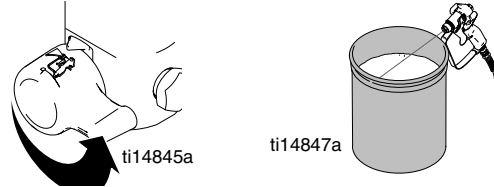

7. Raise siphon tube above flushing fluid and run sprayer for 15 to 30 seconds to drain fluid. Turn power **OFF**

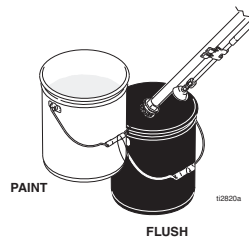

8. Turn prime valve down **DRAIN** position. Unplug sprayer.

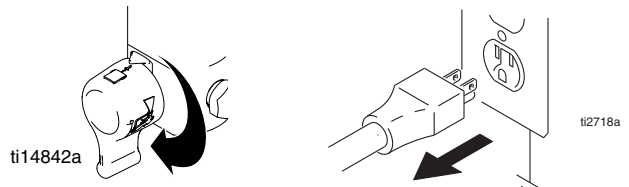

9. Remove filters from gun and sprayer, if installed. Clean and inspect. Install filters.

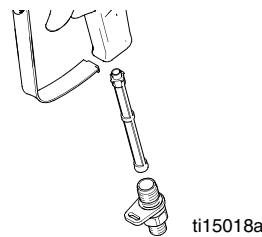

10. If flushing with water, flush again with mineral spirits, or Pump Armor, to leave a protective coating to prevent freezing or corrosion.

11. Wipe sprayer, hose and gun with a rag soaked in water or mineral spirits.



Notes

Notes

Graco Standard Warranty

Graco warrants all equipment referenced in this document which is manufactured by Graco and bearing its name to be free from defects in material and workmanship on the date of sale to the original purchaser for use. With the exception of any special, extended, or limited warranty published by Graco, Graco will, for a period of twelve months from the date of sale, repair or replace any part of the equipment determined by Graco to be defective. This warranty applies only when the equipment is installed, operated and maintained in accordance with Graco's written recommendations.

This warranty does not cover, and Graco shall not be liable for general wear and tear, or any malfunction, damage or wear caused by faulty installation, misapplication, abrasion, corrosion, inadequate or improper maintenance, negligence, accident, tampering, or substitution of non-Graco component parts. Nor shall Graco be liable for malfunction, damage or wear caused by the incompatibility of Graco equipment with structures, accessories, equipment or materials not supplied by Graco, or the improper design, manufacture, installation, operation or maintenance of structures, accessories, equipment or materials not supplied by Graco.

This warranty is conditioned upon the prepaid return of the equipment claimed to be defective to an authorized Graco distributor for verification of the claimed defect. If the claimed defect is verified, Graco will repair or replace free of charge any defective parts. The equipment will be returned to the original purchaser transportation prepaid. If inspection of the equipment does not disclose any defect in material or workmanship, repairs will be made at a reasonable charge, which charges may include the costs of parts, labor, and transportation.

THIS WARRANTY IS EXCLUSIVE, AND IS IN LIEU OF ANY OTHER WARRANTIES, EXPRESS OR IMPLIED, INCLUDING BUT NOT LIMITED TO WARRANTY OF MERCHANTABILITY OR WARRANTY OF FITNESS FOR A PARTICULAR PURPOSE.

Graco's sole obligation and buyer's sole remedy for any breach of warranty shall be as set forth above. The buyer agrees that no other remedy (including, but not limited to, incidental or consequential damages for lost profits, lost sales, injury to person or property, or any other incidental or consequential loss) shall be available. Any action for breach of warranty must be brought within two (2) years of the date of sale.

GRACO MAKES NO WARRANTY, AND DISCLAIMS ALL IMPLIED WARRANTIES OF MERCHANTABILITY AND FITNESS FOR A PARTICULAR PURPOSE, IN CONNECTION WITH ACCESSORIES, EQUIPMENT, MATERIALS OR COMPONENTS SOLD BUT NOT MANUFACTURED BY GRACO. These items sold, but not manufactured by Graco (such as electric motors, switches, hose, etc.), are subject to the warranty, if any, of their manufacturer. Graco will provide purchaser with reasonable assistance in making any claim for breach of these warranties.

In no event will Graco be liable for indirect, incidental, special or consequential damages resulting from Graco supplying equipment hereunder, or the furnishing, performance, or use of any products or other goods sold hereto, whether due to a breach of contract, breach of warranty, the negligence of Graco, or otherwise.

FOR GRACO CANADA CUSTOMERS

The Parties acknowledge that they have required that the present document, as well as all documents, notices and legal proceedings entered into, given or instituted pursuant hereto or relating directly or indirectly hereto, be drawn up in English. Les parties reconnaissent avoir convenu que la rédaction du présente document sera en Anglais, ainsi que tous documents, avis et procédures judiciaires exécutés, donnés ou intentés, à la suite de ou en rapport, directement ou indirectement, avec les procédures concernées.

Graco Information

For the latest information about Graco products, visit www.graco.com.

TO PLACE AN ORDER, contact your Graco distributor or call 1-800-690-2894 to identify the nearest distributor.

All written and visual data contained in this document reflects the latest product information available at the time of publication.

Graco reserves the right to make changes at any time without notice.

For patent information, see www.graco.com/patents.

Original instructions. **This manual contains English. MM 3A0242**

Graco Headquarters: Minneapolis

International Offices: Belgium, China, Japan, Korea

GRACO INC. AND SUBSIDIARIES • P.O. BOX 1441 • MINNEAPOLIS MN 55440-1441 • USA

Copyright 2012, Graco Inc. All Graco manufacturing locations are registered to ISO 9001.

September 2012