

Low Overspray CleanShot™ Valve

311103D
EN

Model 287727

For use on the Graco Low Overspray Kit.

Includes RAC® 5 321 SwitchTip™ and RAC 5 HandTite™ Guard.

3600 psi (25 MPa, 248 bar) Maximum Working Pressure



Important Safety Instructions

Read all warnings and instructions in this manual.
Save these instructions.

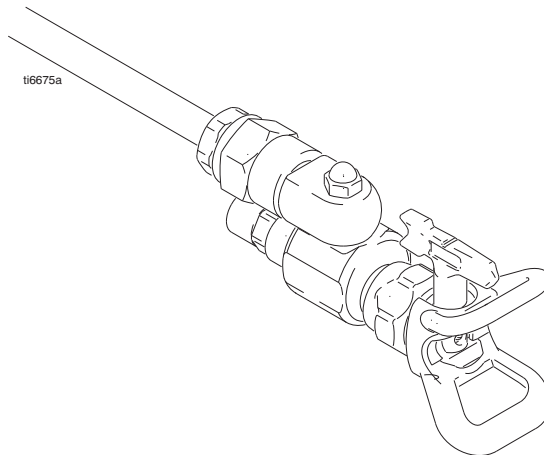



PROVEN QUALITY. LEADING TECHNOLOGY.











Warnings

The following general warnings are related to the safe setup, use, grounding, maintenance and repair of this equipment. In the text of this manual, the exclamation point symbol alerts you to a warning and the hazard symbol refers to specific risks. Refer back to these General Warning pages. Additional procedure-specific warnings will be included where applicable.



WARNING

	<p>FIRE AND EXPLOSION HAZARD</p> <p>Flammable fumes, such as solvent and paint fumes, in work area can ignite or explode. Paint or solvent flowing through the equipment can cause static sparking. To help prevent fire and explosion:</p> <ul style="list-style-type: none"> • Use equipment only in well ventilated area. • Eliminate all ignition sources; such as pilot lights, cigarettes, portable electric lamps, and plastic drop cloths (potential static sparking). • Ground all equipment in the work area. See Grounding instructions. • Never spray or flush solvent at high pressure. • Keep work area free of debris, including solvent, rags and gasoline. • Do not plug or unplug power cords, or turn power or light switches on or off when flammable fumes are present. • Use only grounded hoses. • Hold gun firmly to side of grounded pail when triggering into pail. Do not use pail liners unless they are anti-static or conductive. • Stop operation immediately if static sparking occurs or you feel a shock. Do not use equipment until you identify and correct the problem. • Keep a working fire extinguisher in the work area.
	<p>SKIN INJECTION HAZARD</p> <p>High-pressure spray is able to inject toxins into the body and cause serious bodily injury. In the event that injection occurs, get immediate surgical treatment.</p> <ul style="list-style-type: none"> • Do not aim the gun at, or spray any person or animal. • Keep hands and other body parts away from the discharge. For example, do not try to stop leaks with any part of the body. • Always use the nozzle tip guard. Do not spray without nozzle tip guard in place. • Use Graco nozzle tips. • Use caution when cleaning and changing nozzle tips. In the case where the nozzle tip clogs while spraying, follow the Pressure Relief Procedure for turning off the unit and relieving the pressure before removing the nozzle tip to clean. • Equipment maintains pressure after power is shut off. Do not leave the equipment energized or under pressure while unattended. Follow the Pressure Relief Procedure when the equipment is unattended or not in use, and before servicing, cleaning, or removing parts. • Check hoses and parts for signs of damage. Replace any damaged hoses or parts. • This system is capable of producing 3600 psi. Use Graco replacement parts or accessories that are rated a minimum of 3600 psi. • Always engage the trigger lock when not spraying. Verify the trigger lock is functioning properly. • Verify that all connections are secure before operating the unit. • Know how to stop the unit and bleed pressure quickly. Be thoroughly familiar with the controls.

WARNING

  	<p>PRESSURIZED EQUIPMENT HAZARD</p> <p>Fluid from the gun/dispense valve, leaks, or ruptured components can splash in the eyes or on skin and cause serious injury.</p> <ul style="list-style-type: none"> • Follow Pressure Relief Procedure in this manual, when you stop spraying and before cleaning, checking, or servicing equipment. • Tighten all fluid connections before operating the equipment. • Check hoses, tubes, and couplings daily. Replace worn or damaged parts immediately.
 	<p>EQUIPMENT MISUSE HAZARD</p> <p>Misuse can cause death or serious injury.</p> <ul style="list-style-type: none"> • Do not exceed the maximum working pressure or temperature rating of the lowest rated system component. See Technical Data in all equipment manuals. • Use fluids and solvents that are compatible with equipment wetted parts. See Technical Data in all equipment manuals. Read fluid and solvent manufacturer's warnings. • Check equipment daily. Repair or replace worn or damaged parts immediately. • Do not alter or modify equipment. • Use equipment only for its intended purpose. Call your Graco distributor for information. • Route hoses and cables away from traffic areas, sharp edges, moving parts, and hot surfaces. • Do not kink or over bend hoses or use hoses to pull equipment. • Keep children and animals away from work area. • Comply with all applicable safety regulations.
	<p>PRESSURIZED ALUMINUM PARTS HAZARD</p> <p>Do not use 1,1,1-trichloroethane, methylene chloride, other halogenated hydrocarbon solvents or fluids containing such solvents in pressurized aluminum equipment. Such use can cause serious chemical reaction and equipment rupture, and result in death, serious injury, and property damage.</p>
 	<p>MOVING PARTS HAZARD</p> <p>Moving parts can pinch or amputate fingers and other body parts.</p> <ul style="list-style-type: none"> • Keep clear of moving parts. • Do not operate equipment with protective guards or covers removed. • Pressurized equipment can start without warning. Before checking, moving, or servicing equipment, follow the Pressure Relief Procedure in this manual. Disconnect power or air supply.
	<p>PERSONAL PROTECTIVE EQUIPMENT</p> <p>You must wear appropriate protective equipment when operating, servicing, or when in the operating area of the equipment to help protect you from serious injury, including eye injury, inhalation of toxic fumes, burns, and hearing loss. This equipment includes but is not limited to:</p> <ul style="list-style-type: none"> • Protective eyewear • Clothing and respirator as recommended by the fluid and solvent manufacturer • Gloves • Hearing protection

Pressure Relief Procedure

Follow when you stop spraying and before cleaning, checking, servicing, or transporting equipment. Read warnings.



1. Engage trigger lock.
2. Close the bleed-type master air valve.
3. Disengage the trigger lock.
4. Hold a metal part of the gun firmly to a grounded metal pail. Trigger the gun to relieve pressure.

5. Engage the trigger lock.
6. Open all fluid drain valves in the system, having a waste container ready to catch drainage. Leave drain valve(s) open until you are ready to spray again.
7. If you suspect the spray tip or hose is clogged or that pressure has not been fully relieved after following the steps above, VERY SLOWLY loosen tip guard retaining nut or hose end coupling to relieve pressure gradually, then loosen completely. Clear hose or tip obstruction.

Trigger Lock

Always engage the trigger lock when you stop spraying to prevent the gun from being triggered accidentally by hand or if dropped or bumped.

Installation

				
<p>To reduce the risk of serious bodily injury from fluid injection or splashing in the eyes or on the skin, stop using the nozzle immediately if it starts to leak or cannot be turned easily..</p>				

Installing the Tip and Guard (Fig. 1 and Fig. 2)

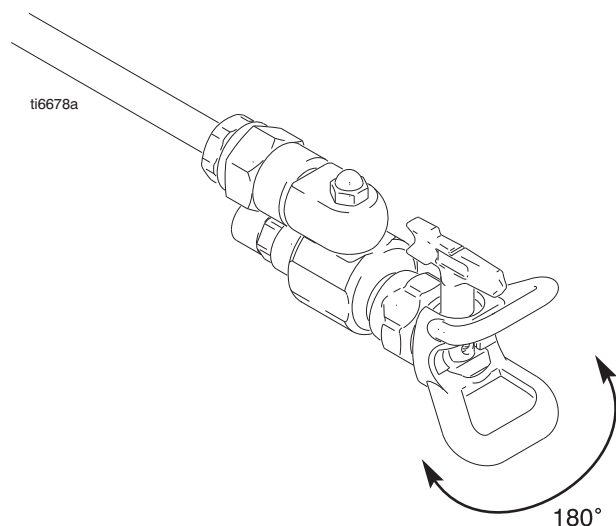

Fig.1 _____

- 1 Without the spray tip installed, start sprayer, turn the knob on the Low Overspray CleanShot Valve counter-clockwise to the FLUSH position (Fig. 2 [C]).
- 2 Flush and prime the spray system.
- 3 Follow the **Pressure Relief Procedure** described in the warning pages of this manual.
- 4 Install the spray tip.
- 5 Turn the knob of the Low Overspray CleanShot Valve to SPRAY (Fig. 2 [B]).
- 6 Rotate the Low Overspray CleanShot Valve to any desired position within 180°. Do not use any tools.
- 7 Refer to your separate gun instruction manual for operating and tip cleaning instructions.
- 8 This adapter is repairable.

NOTICE

To avoid damage to the o-ring in the swivel:

- Relieve fluid pressure before rotating the swivel.
- Do not soak the entire swivel in solvent.

Flush and Spray

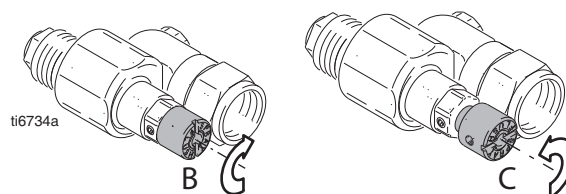

Fig. 2 _____

The CleanShot valve is adjustable when spraying at different pressures. The valve comes set for high pressure (B). Turn the knob to adjust for lower pressure applications to minimize overspray. Turn the knob to FLUSH (C) when cleaning or when very low pressure is desired, below 700 PSI (48 bar, 4.8 MPa).

Parts

CleanShot Repair Kit 244162 (31)

Swivel Repair Kit 244363 (35)†

Valve Body Kit 245687 (36)*†

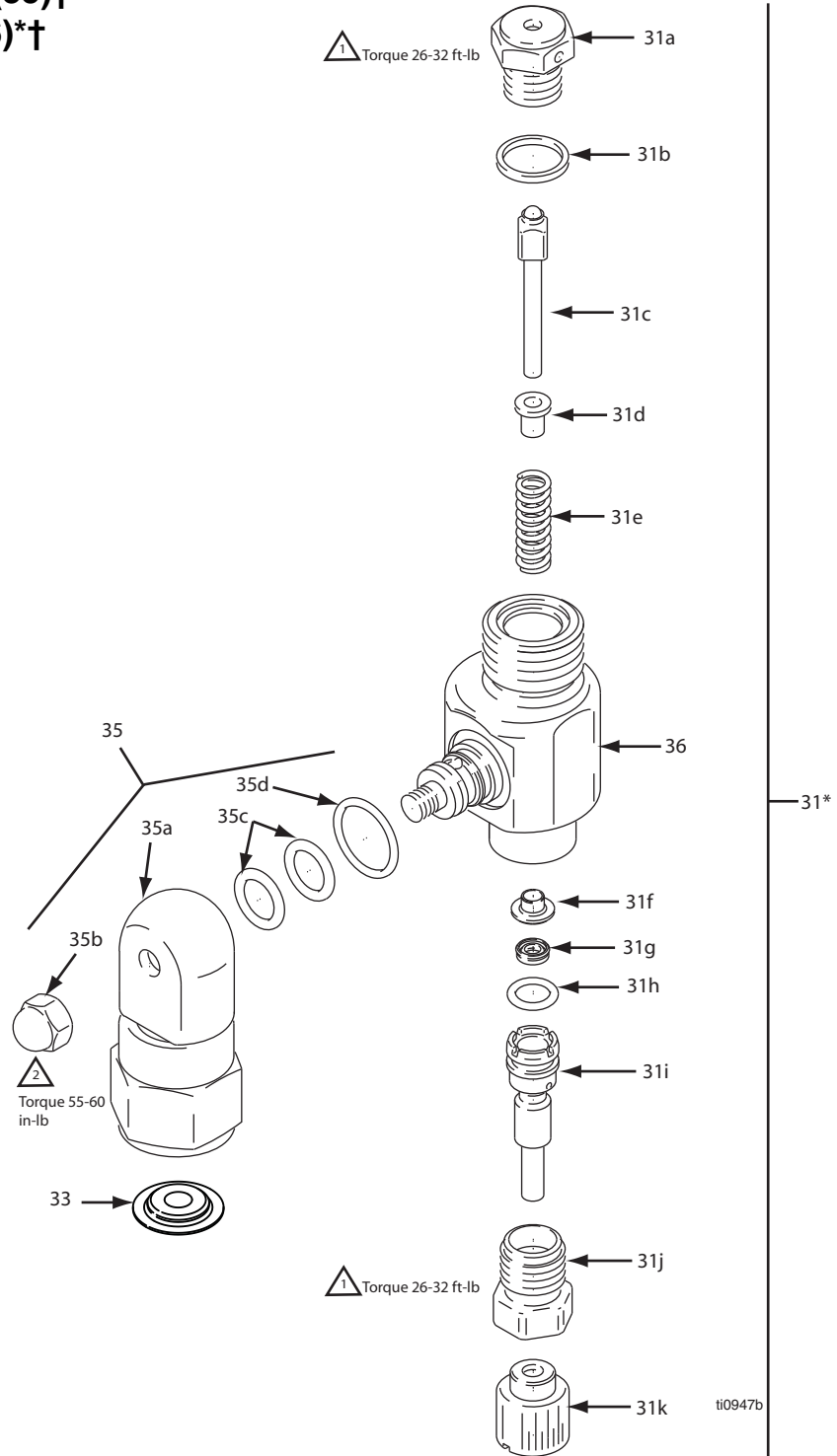

* 36 Valve Body Kit must be purchased separately

† Series A and B

Parts List

Ref.	No.	Part No.	Description	Qty.
	31	244162	KIT, CleanShot, repair includes 31a-31k	1
	31a		SEAT, valve	1
	31b		GASKET	1
	31c		RETAINER, ball	1
	31d		DAMPENER, spring	1
	31e		SPRING, compression	1
	31f		GUIDE, spring	1
	31g		SEAL, u-cup	1
	31h		PACKING, o-ring	1
	31i		RETAINER, u-cup	1
	31j		CAP, end, u-cup	1
	31k		KNOB, valve	1
	33	15H622	GASKET, non-metallic	2
	35	244363	KIT, swivel repair	1
	35a	244663	SWIVEL, inlet assembly	1
	35b	120189	NUT, cap	1
	35c	107505	PACKING, o-ring	2
	35d	109576	PACKING, o-ring	1
	36	245687	KIT, valve body	1
	36a		STUD, manifold	1
	36b		GASKET, nylon	1
	36c		VALVE, outlet	1
		LL5321	RAC 5 TIP, spray, striping (not shown)	
		243160	RAC 5 HandTite Guard (not shown)	

Technical Data

Wetted parts Aluminum, Tungsten, Carbide,
PTFE, Stainless Steel

Fluid inlet/outlet 7/8-14 UNF

Maximum working pressure 3600 psi (25 MPa,
248 bar)

Graco Standard Warranty

Graco warrants all equipment referenced in this document which is manufactured by Graco and bearing its name to be free from defects in material and workmanship on the date of sale to the original purchaser for use. With the exception of any special, extended, or limited warranty published by Graco, Graco will, for a period of twelve months from the date of sale, repair or replace any part of the equipment determined by Graco to be defective. This warranty applies only when the equipment is installed, operated and maintained in accordance with Graco's written recommendations.

This warranty does not cover, and Graco shall not be liable for general wear and tear, or any malfunction, damage or wear caused by faulty installation, misapplication, abrasion, corrosion, inadequate or improper maintenance, negligence, accident, tampering, or substitution of non-Graco component parts. Nor shall Graco be liable for malfunction, damage or wear caused by the incompatibility of Graco equipment with structures, accessories, equipment or materials not supplied by Graco, or the improper design, manufacture, installation, operation or maintenance of structures, accessories, equipment or materials not supplied by Graco.

This warranty is conditioned upon the prepaid return of the equipment claimed to be defective to an authorized Graco distributor for verification of the claimed defect. If the claimed defect is verified, Graco will repair or replace free of charge any defective parts. The equipment will be returned to the original purchaser transportation prepaid. If inspection of the equipment does not disclose any defect in material or workmanship, repairs will be made at a reasonable charge, which charges may include the costs of parts, labor, and transportation.

THIS WARRANTY IS EXCLUSIVE, AND IS IN LIEU OF ANY OTHER WARRANTIES, EXPRESS OR IMPLIED, INCLUDING BUT NOT LIMITED TO WARRANTY OF MERCHANTABILITY OR WARRANTY OF FITNESS FOR A PARTICULAR PURPOSE.

Graco's sole obligation and buyer's sole remedy for any breach of warranty shall be as set forth above. The buyer agrees that no other remedy (including, but not limited to, incidental or consequential damages for lost profits, lost sales, injury to person or property, or any other incidental or consequential loss) shall be available. Any action for breach of warranty must be brought within two (2) years of the date of sale.

GRACO MAKES NO WARRANTY, AND DISCLAIMS ALL IMPLIED WARRANTIES OF MERCHANTABILITY AND FITNESS FOR A PARTICULAR PURPOSE, IN CONNECTION WITH ACCESSORIES, EQUIPMENT, MATERIALS OR COMPONENTS SOLD BUT NOT MANUFACTURED BY GRACO. These items sold, but not manufactured by Graco (such as electric motors, switches, hose, etc.), are subject to the warranty, if any, of their manufacturer. Graco will provide purchaser with reasonable assistance in making any claim for breach of these warranties.

In no event will Graco be liable for indirect, incidental, special or consequential damages resulting from Graco supplying equipment hereunder, or the furnishing, performance, or use of any products or other goods sold hereto, whether due to a breach of contract, breach of warranty, the negligence of Graco, or otherwise.

FOR GRACO CANADA CUSTOMERS

The Parties acknowledge that they have required that the present document, as well as all documents, notices and legal proceedings entered into, given or instituted pursuant hereto or relating directly or indirectly hereto, be drawn up in English. Les parties reconnaissent avoir convenu que la rédaction du présente document sera en Anglais, ainsi que tous documents, avis et procédures judiciaires exécutés, donnés ou intentés, à la suite de ou en rapport, directement ou indirectement, avec les procédures concernées.

TO PLACE AN ORDER, contact your Graco distributor, or call 1-800-690-2894 to identify the distributor closest to you.D

***TO PLACE AN ORDER OR FOR SERVICE, contact your Airlessco distributor,
or call 1-800-223-8213 to identify the nearest distributor.***

*All written and visual data contained in this document reflects the latest product information available at the time of publication.
Airlessco reserves the right to make changes at any time without notice.*

Original Instructions. This manual contains English. MM 311103

GRACO INC. AND SUBSIDIARIES • P.O. BOX 1441 • MINNEAPOLIS MN 55440-1441 • USA

**Copyright 2005, Graco Inc. All Graco manufacturing locations are registered to ISO 9001.
Revision D - 5/2016**