

GMAX™ 3400 无气喷涂机



333350E
ZH

— 适用于建筑涂层和涂料的便携式无气喷涂 —

3300 磅 / 平方英寸 (22.8 兆帕, 228 巴) 最大工作压力



请阅读所有警告和说明

			
248664	✓		✓
248666		✓	✓



310813



311861



309250





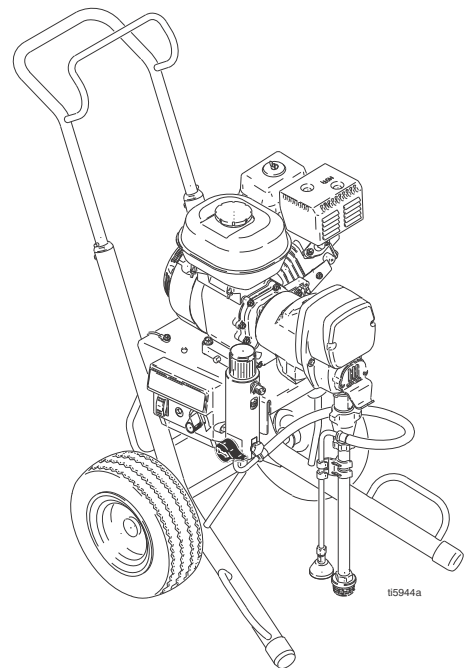

309640



PROVEN QUALITY. LEADING TECHNOLOGY.

警告

下列警告包括了有关本设备的一般性安全信息。与特定产品有关的进一步警告可能会出现在文中适当的地方。

 警告	
	<p>火灾和爆炸危险</p> <p>若溶剂、涂料烟气等在工作区内形成可燃烟雾，会有火灾或爆炸危险。为防止起火和爆炸：</p> <ul style="list-style-type: none"> • 仅在通风良好的地方使用此设备。 • 不得在发动机运行或发热时向箱内添加燃油；应关闭发动机并使其冷却。燃油是易燃品，如果溅到热表面上即可被点燃或爆炸。 • 喷涂易燃液体或用易燃液体进行冲洗或清洗时，要让喷涂机离开爆炸性蒸气至少 20 英尺（6 米）。 • 清除所有火源，如引火火焰、烟头、手提电灯及塑胶遮蔽布（可产生静电火花）。 • 保持工作区清洁，无溶剂、碎片、汽油等杂物。 • 存在易燃烟雾时不要插拔电源插头或开关电源或电灯。 • 将工作区内的设备及导电物体接地。请参见接地说明。 • 只能使用已接地的软管。 • 朝桶内扣动扳机时，要握紧喷枪靠在接地桶的边上。 • 如果出现静电火花或感到有电击，则应立即停止操作。在找出并纠正问题之前，不要使用设备。
	<p>注射危险</p> <p>从喷枪、软管泄漏处或破裂的部件中射出的高压流体会刺破皮肤。伤势看起来会像“只划了一小口”，其实是严重伤害，可能导致肢体切除。应即刻进行手术治疗。</p> <ul style="list-style-type: none"> • 不要将喷枪指着任何人或身体的任何部位。 • 不要将手放在喷嘴上。 • 不要用手、身体、手套或抹布去堵住或挡住泄漏部件。 • 不要在没有安装喷嘴护罩及扳机护圈的情况下进行喷涂。 • 不喷涂时要锁上扳机锁。 • 在停止喷涂时以及在清洗、检查或维修设备之前，要按照本手册的泄压步骤操作。
	<p>高压设备危险</p> <p>从喷枪 / 分配阀、泄漏处或破裂的部件流出来的流体，会溅入眼内或皮肤上，导致严重伤害。</p> <ul style="list-style-type: none"> • 在停止喷涂时以及在清洗、检查或维修设备之前，要按照本手册的泄压步骤操作。 • 在操作设备前要旋紧所有流体连接处。 • 要每天检查软管、吸料管和接头。已磨损或损坏的部件要立刻更换。
	<p>移动部件危险</p> <p>移动的部件会挤夹或切断手指及身体的其它部位。</p> <ul style="list-style-type: none"> • 要避开移动的部件。 • 在护罩被取下或外盖被打开时，不要操作设备。 • 加压设备启动时可能没有任何警告。在检查、移动或维修本设备之前，应按照本手册中的泄压步骤进行操作。断开电源或气源。



警告

	<p>设备误用危险 误用设备会导致严重的人员伤亡。</p> <ul style="list-style-type: none"> • 不要超过额定值最低的系统部件的最大工作压力或温度额定值。参见所有设备手册中的技术数据。 • 请使用与设备的接液部件相适应的流体或溶剂。参见所有设备手册中的技术数据。阅读流体及溶剂生产厂家的警告。 • 要每天检查设备。已磨损或损坏的部件要立刻修理或更换。 • 不要对设备进行改动或修改。 • 仅适合专业用途。 • 只能将设备用于其指定用途。有关信息，请与 Graco 公司的经销商联系。 • 让软管和电缆远离公共区域、尖锐边缘、移动部件及热的表面。 • 不要用软管拽拉设备。 • 要遵照所有适用的安全规定进行。
	<p>高压铝质部件危险 不得在加压的铝质装置中使用 1, 1, 1-三氯乙烷、二氯甲烷、其它卤代烃溶剂或含有这些溶剂的流体。否则会导致剧烈的化学反应和设备破裂，并可造成严重的人员伤亡及财产损失。</p>
	<p>吸力危险 对泵进行操作或加压时，切勿将手放在泵流体入口附近。强大的吸力可能造成严重伤害。</p>
	<p>一氧化碳危险 排气装置包含有毒一氧化碳，无色无味。吸入一氧化碳可能会致人死亡。不要在密闭区域操作。</p>
	<p>流体或烟雾中毒危险 如果吸入有毒的烟雾、食入有毒的流体或让它们溅到眼睛里或皮肤上，都会导致严重伤害或死亡。</p> <ul style="list-style-type: none"> • 应阅读材料安全数据表 (MSDS)，熟悉所用流体的特殊危险性。 • 危险性流体要存放在规定的容器内，并按照有关规定的要求进行处置。
	<p>烧伤危险 设备表面及加热的流体在工作期间会变得非常热。为了避免严重烧伤，不要接触热的流体或设备。要待设备 / 流体完全冷却之后再触摸。</p>
	<p>个人防护装备 在操作或维修设备时，或在进入设备的工作区时，必须穿戴适当的防护装备，以免受到严重伤害，包括眼睛损伤、吸入有毒烟雾、烧伤以及听力损伤。这些装备包括但不限于：</p> <ul style="list-style-type: none"> • 护目镜 • 流体和溶剂生产厂家所推荐的防护服及呼吸器 • 手套 • 听力保护装置
	<p>后坐力危险 扣动扳机时喷枪可能会有后坐力，导致您跌倒并造成严重损伤，请支撑好您自己。</p>

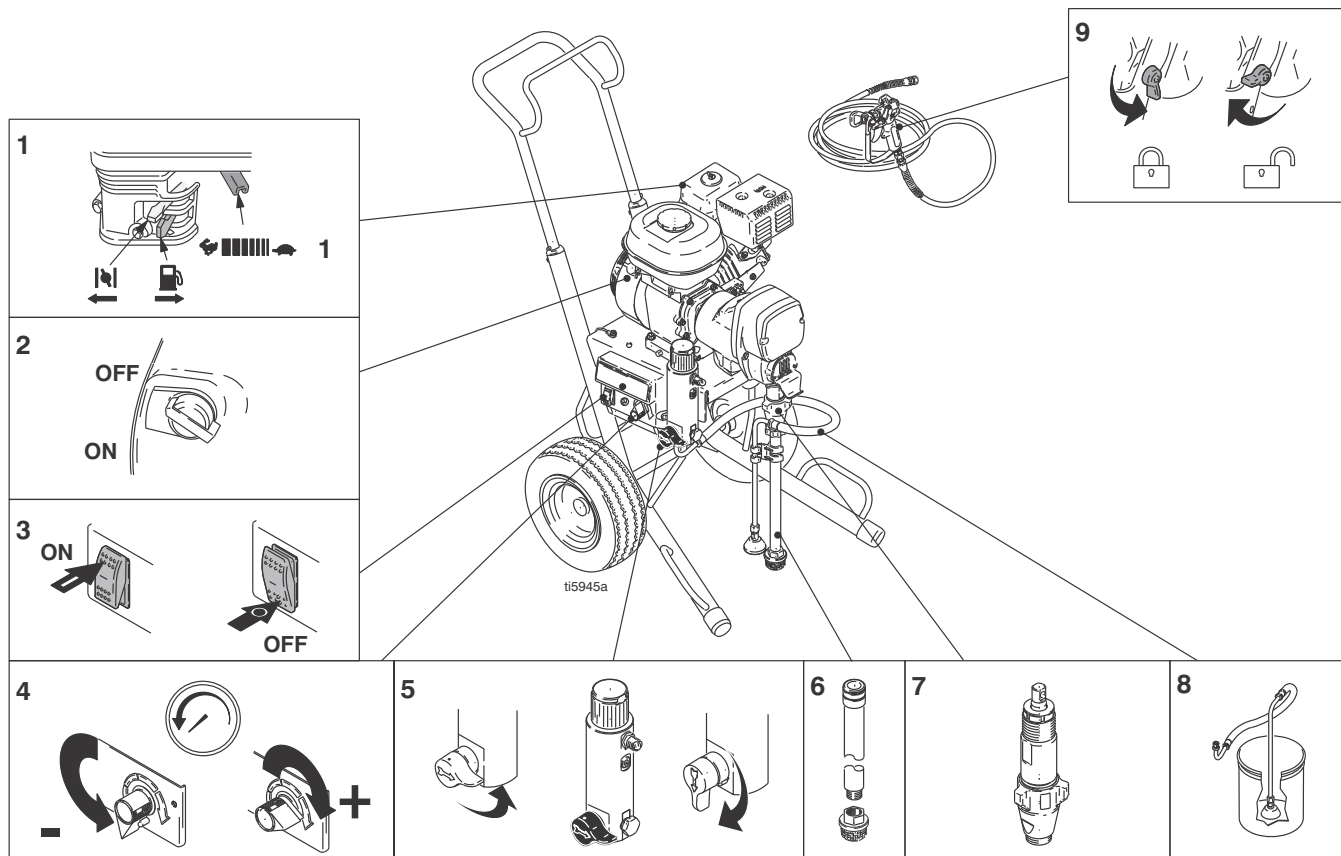

	中文
1	发动机控制器
2	发动机 ON/OFF 开关
3	泵 ON/OFF 开关
4	压力控制器
5	填料阀和过滤器
6	吸料管
7	泵
8	回流管
9	扳机锁

设置

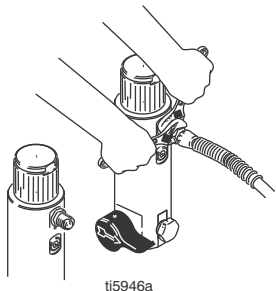
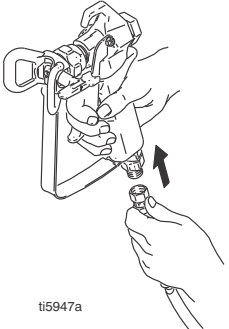
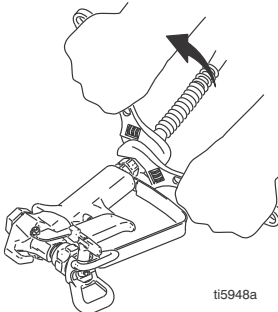
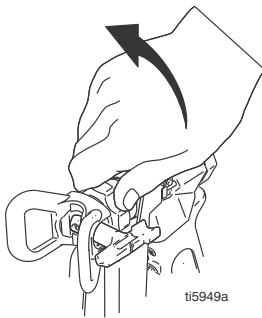
 <p>ti5946a</p>	 <p>ti5947a</p>	 <p>ti5948a</p>	 <p>ti5949a</p>
<p>1 将适当的 Graco 高压软管连接到喷涂机上。牢牢旋紧。</p>	<p>2 将软管的另一端连接到喷枪上。</p>	<p>3 牢牢旋紧。</p>	<p>4 取下喷嘴护罩。</p>

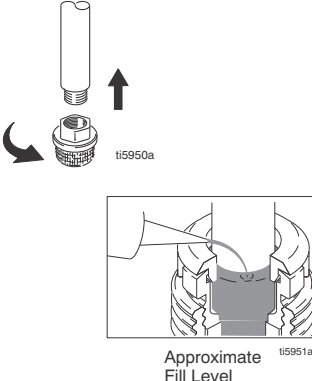
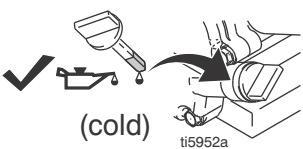
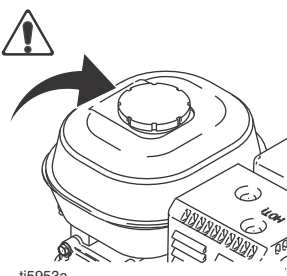
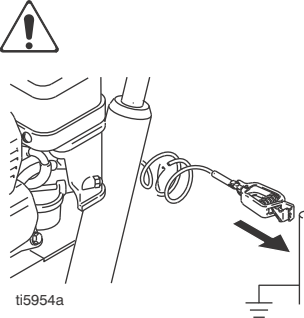
 <p>ti5950a</p> <p>Approximate Fill Level ti5951a</p>	 <p>(cold) ti5952a</p>	 <p>ti5953a</p>	 <p>ti5954a</p>
<p>5 装上洁净的入口过滤器。给喉部密封螺母填充喉管密封液 (TSL)，以延长泵的使用寿命每次喷涂和存放时都要这样做。</p>	<p>6 检查机油位。如果有必要，可添加 SAE 10W-30 (夏季) 或 5W-30 (冬季)。请参见本田 (Honda) 发动机用户手册。</p>	<p>7 给燃油箱加油。</p>	<p>8 将喷涂机的接地夹接地。</p>

启动

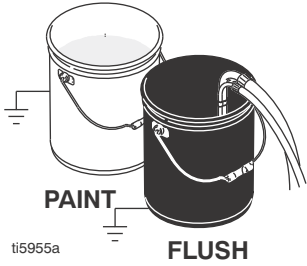
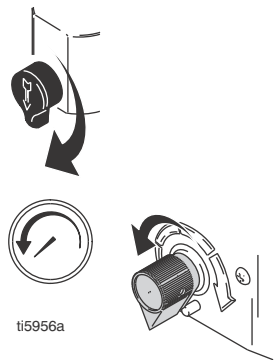
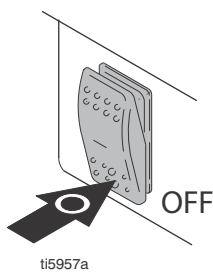
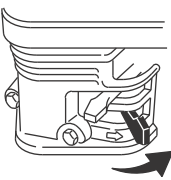
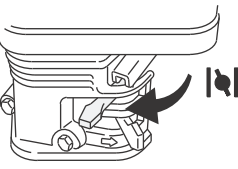
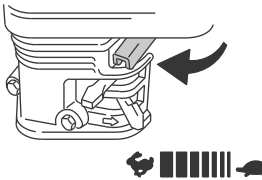
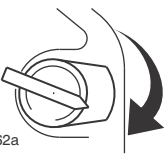
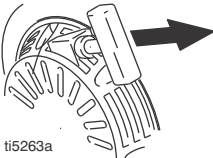
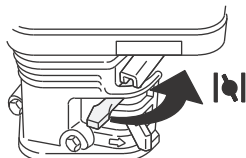
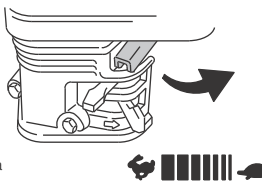
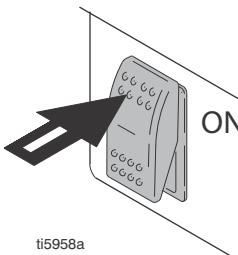
 <p>ti5955a</p>	 <p>ti5956a</p>	 <p>ti5957a</p>	
<p>1 将吸料管和回流管放入盛有冲洗液的接地金属桶内。用接地导线将桶接地。</p>	<p>2 关闭填料阀。将压力控制旋钮逆时针转动到最低压力值。</p>	<p>3 将泵开关于 OFF 位置。</p>	
 <p>ti5248a</p>	 <p>ti5249a</p>	 <p>ti5250a</p>	 <p>ti5262a</p>
<p>4 启动发动机。</p> <p>a 将燃油阀推到打开位置。</p>	<p>b 将阻风门推到关闭位置。</p>	<p>c 将节流阀设在快速档。</p>	<p>d 将发动机开关切换至 ON 位置。</p>
 <p>ti5263a</p>	 <p>ti5264a</p>	 <p>ti5251a</p>	 <p>ti5958a</p>
<p>e 拉出启动绳。</p>	<p>f 发动机启动后，将阻风门推到打开位置。</p>	<p>g 将节流阀设在所期望的位置。</p>	<p>5 将泵开关于 ON 位置。 — 泵 / 离合器现已处于工作状态 —</p>

<p>15 SEC</p> <p>ti5959a</p>	<p>safety OFF</p> <p>ti5960a</p>	<p>ti5961a</p>	
<p>6 将压力增大至足以使泵启动运行，然后让流体循环 15 秒钟；将压力降低并将填料阀转动至水平位置。</p>	<p>7 打开喷枪扳机的安全销。</p>	<p>8 握住喷枪靠在接地的金属冲洗桶上。扣动喷枪扳机并缓慢增大流体压力，直到泵运行平稳为止。</p>	<p>检查各接头是否有泄漏。不要用手或抹布去堵泄漏！如果出现泄漏，则应立即关闭喷涂机。在清洗中进行压力释放（第 17 页 1. - 3.）。旋紧泄漏的接头。重复启动步骤 1 - 5。如果没有泄漏，则继续扣动喷枪扳机直至系统已彻底冲洗。进行第 6 步。</p>

<p>ti5962a</p> <p>PAINT</p>	<p>ti5963a</p> <p>FLUSH</p>	<p>safety ON</p> <p>ti5964a</p> <p>Switch Tip</p> <p>seat</p> <p>OneSeal</p> <p>ti5965a</p>	<p>ti5966a</p>
<p>9 将吸料管放入涂料桶中。</p>	<p>10 再次朝冲洗流体桶内扣动喷枪扳机，直到有涂料流出。组装喷嘴及护罩（第 7 页）。</p>	<p>SwitchTip 和护罩组件</p> <p>1 锁上扳机安全销。插入 SwitchTip 喷嘴。插入金属座和 OneSeal。</p>	<p>2 将组件旋到喷枪上。用手旋紧。</p>

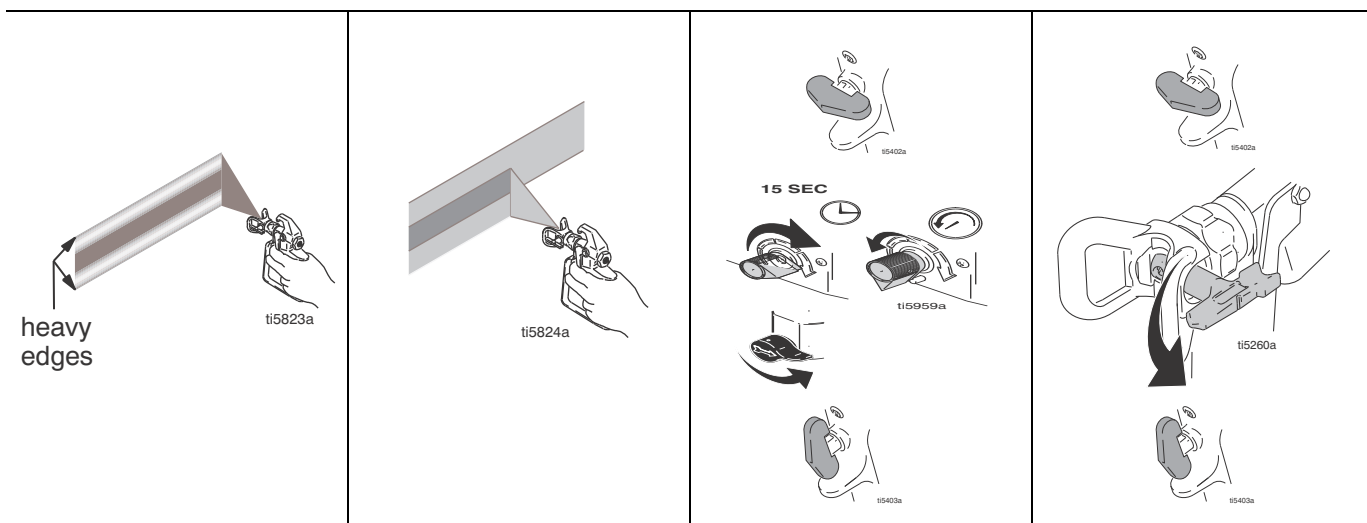

喷涂测试喷型

1 扣动喷枪扳机并喷涂测试 喷型。缓慢调整压力以消除厚边。如果无法通过调整压力消除厚边，可换用尺寸较小的喷嘴。



2 握住喷枪与表面垂直并距离表面 10-12 英寸 (25-30 厘米)。来回喷涂。让喷涂面有 50% 的重叠。在扣动 喷枪扳机之前开始移动喷枪，在松开扳机之后再停止移动喷枪。

清除喷嘴堵塞物

1 释放扳机，锁上扳机安全销。旋转 SwitchTip。打开扳机的安全销并扣动喷枪以清除堵塞物。

2 锁上扳机安全销，将 SwitchTip 旋转到原始位置，然后打开扳机的安全销并继续喷涂。

泄压

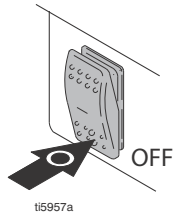
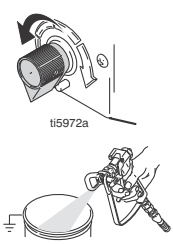
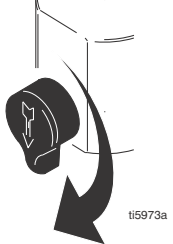
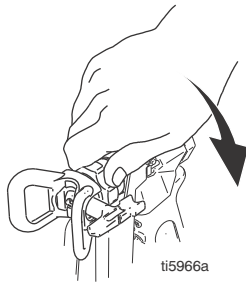
			
 <p>ti5957a</p> <p>OFF</p>	 <p>ti5972a</p> <p>PAINT</p>	 <p>ti5973a</p>	 <p>ti5966a</p>
<p>1 将泵阀置于 OFF 位置。 关闭发动机。</p>	<p>2 将压力调到最低值。朝桶内扣 动喷枪扳机，使压力释放掉。</p>	<p>3 关闭填料阀。</p>	<p>4 取下护罩及 SwitchTip 喷嘴。</p>

清洗

 <p>ti5975a</p>	 <p>ti5976a</p> <p>FLUSH</p>	 <p>ti5977a</p> <p>FLUSH</p>	 <p>ti5978a</p>  <p>ti5979a</p>
<p>1 进行泄压（第 9 页）。旋下滤杯，卸下过滤器。不带过滤器重新装上。清洗过滤器</p>	<p>2 将过滤器、护罩及 SwitchTip 喷嘴在冲洗液中清洗。</p>	<p>3 将吸料管套件从涂料中取出，然后放入冲洗液中。水性涂料用水，油性涂料用矿物油精。</p>	<p>4 接通发动机开关并启动发动机。将泵阀置于 ON 位置。将填料阀转动至水平位置。</p>
 <p>ti5980a</p> <p>PAINT</p>	 <p>ti5981a</p> <p>FLUSH</p>	 <p>20 SEC</p> <p>ti5982a</p>	 <p>ti5275a</p> <p>PAINT</p> <p>FLUSH</p>  <p>ti5971a</p> <p>OFF</p>
<p>5 握住喷枪靠在涂料桶上。打开扳机的安全销。转动压力控制旋钮以增大压力，直到电机开始驱动泵运行。扣动喷枪扳机直到有冲洗液流出。</p>	<p>6 将喷枪移向冲洗桶，握住喷枪靠在桶上，扣动喷枪扳机使系统彻底冲洗。释放扳机并锁上扳机安全销。</p>	<p>7 将填料阀向下旋转，然后让冲洗液循环大约 20 秒钟以清洗回流管。</p>	<p>8 将吸料管提升到冲洗液的液面之上并运行喷涂机 15 至 30 秒钟，以将流体排出。关闭泵阀。关闭发动机。</p>

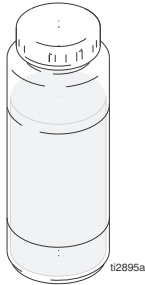
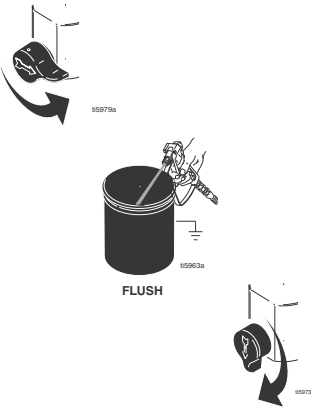
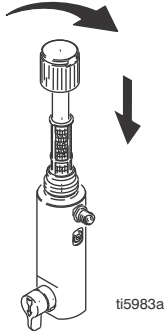
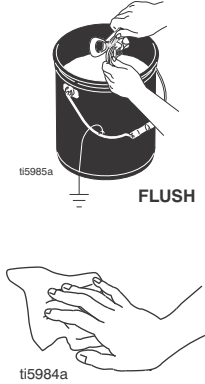
 <p>Pump Armor ti2895a</p>	 <p>ti5979a ti5963a FLUSH ti5979a</p>	 <p>ti5983a</p>	 <p>ti5985a FLUSH ti5984a</p>
<p>告诫：如果用水冲洗，不要使喷涂机内残留水分。用矿物油精、油或 Pump Armor 重新冲洗一遍，并在喷涂机内留下这层保护性涂层，以避免结冰或腐蚀，并延长喷涂机的寿命。</p>	<p>9 关闭填料阀。朝冲洗桶内扣动喷枪扳机，以排出软管内的流体。打开填料阀。</p>	<p>10 将过滤器装到滤杯中。确保中央的塑料管可靠固定。用手旋紧滤杯。用手旋紧喷枪手柄。</p>	<p>11 用软毛刷清洗喷嘴、护罩及垫圈，以防止干固涂料造成部件故障。将部件装配在一起并松垮地装到喷枪上。用一块在水或矿物油精中浸泡过的抹布擦洗喷涂机、软管及喷枪。</p>

Warranty

Graco warrants all equipment referenced in this document which is manufactured by Graco and bearing its name to be free from defects in material and workmanship on the date of sale to the original purchaser for use. With the exception of any special, extended, or limited warranty published by Graco, Graco will, for a period of twelve months from the date of sale, repair or replace any part of the equipment determined by Graco to be defective. This warranty applies only when the equipment is installed, operated and maintained in accordance with Graco's written recommendations.

This warranty does not cover, and Graco shall not be liable for general wear and tear, or any malfunction, damage or wear caused by faulty installation, misapplication, abrasion, corrosion, inadequate or improper maintenance, negligence, accident, tampering, or substitution of non-Graco component parts. Nor shall Graco be liable for malfunction, damage or wear caused by the incompatibility of Graco equipment with structures, accessories, equipment or materials not supplied by Graco, or the improper design, manufacture, installation, operation or maintenance of structures, accessories, equipment or materials not supplied by Graco.

This warranty is conditioned upon the prepaid return of the equipment claimed to be defective to an authorized Graco distributor for verification of the claimed defect. If the claimed defect is verified, Graco will repair or replace free of charge any defective parts. The equipment will be returned to the original purchaser transportation prepaid. If inspection of the equipment does not disclose any defect in material or workmanship, repairs will be made at a reasonable charge, which charges may include the costs of parts, labor, and transportation.

THIS WARRANTY IS EXCLUSIVE, AND IS IN LIEU OF ANY OTHER WARRANTIES, EXPRESS OR IMPLIED, INCLUDING BUT NOT LIMITED TO WARRANTY OF MERCHANTABILITY OR WARRANTY OF FITNESS FOR A PARTICULAR PURPOSE.

Graco's sole obligation and buyer's sole remedy for any breach of warranty shall be as set forth above. The buyer agrees that no other remedy (including, but not limited to, incidental or consequential damages for lost profits, lost sales, injury to person or property, or any other incidental or consequential loss) shall be available. Any action for breach of warranty must be brought within two (2) years of the date of sale.

GRACO MAKES NO WARRANTY, AND DISCLAIMS ALL IMPLIED WARRANTIES OF MERCHANTABILITY AND FITNESS FOR A PARTICULAR PURPOSE, IN CONNECTION WITH ACCESSORIES, EQUIPMENT, MATERIALS OR COMPONENTS SOLD BUT NOT MANUFACTURED BY GRACO. These items sold, but not manufactured by Graco (such as electric motors, switches, hose, etc.), are subject to the warranty, if any, of their manufacturer. Graco will provide purchaser with reasonable assistance in making any claim for breach of these warranties.

In no event will Graco be liable for indirect, incidental, special or consequential damages resulting from Graco supplying equipment hereunder, or the furnishing, performance, or use of any products or other goods sold hereto, whether due to a breach of contract, breach of warranty, the negligence of Graco, or otherwise.

ADDITIONAL WARRANTY COVERAGE

Graco does provide extended warranty and wear warranty for products described in the "Graco Contractor Equipment Warranty Program".

Graco Information

For the latest information about Graco products, visit www.graco.com.

TO PLACE AN ORDER, contact your Graco distributor or call 1-800-690-2894 to identify the nearest distributor

All written and visual data contained in this document reflects the latest product information available at the time of publication.

Graco reserves the right to make changes at any time without notice.

For patent information, see www.graco.com/patents.
 技术手册原文翻译。This manual contains Chinese. MM 310802

Graco Headquarters: Minneapolis

International Offices: Belgium, China, Japan, Korea

GRACO INC. AND SUBSIDIARIES • P. O. BOX 1441 • MINNEAPOLIS MN 55440-1441 • USA

Copyright 2012, Graco Inc. All Graco manufacturing locations are registered to ISO 9001.

September 2012